



Operating Manual  
Research Camera Models:  
STL-1001E, STL-1301E, STL-4020M,  
STL-6303E and STL-11000M

Santa Barbara Instrument Group  
147A Castilian Drive  
Santa Barbara, CA 93117  
Phone (805) 571-7244 • Fax (805) 571-1147  
Web:<[www.sbig.com](http://www.sbig.com)> • Email:<[sbig@sbig.com](mailto:sbig@sbig.com)>

Note: This equipment has been tested and found to comply with the limits for a Class B digital device pursuant to Part 15 of the FCC Rules. These limits are designed to provide reasonable protection against harmful interference in a residential installation. This equipment generates, uses, and can radiate radio frequency energy and if not installed and used in accordance with the instructions, may cause harmful interference to radio communications. However, there is no guarantee that interference will not occur in a particular installation. If this equipment does cause harmful interference to radio or television reception, which can be determined by turning the equipment off and on, the user is encouraged to try to correct the interference by one or more of the following measures:

- Reorient or relocate the receiving antenna.
- Increase the separation between the receiver and the equipment.
- Connect the equipment into an outlet on a circuit different from that to which the receiver is connected.
- Consult the dealer or an experienced radio/TV technician for help.

Shielded I/O cables must be used when operating this equipment.

You are also warned, that any changes to this certified device will void your legal right to operate it.

---

OPERATION Manual for STL-1001E/1301E/4020M/6303E/11000M

Revision 1.0

October 2003

## Section 1 - Introduction

<b>1.</b>	<b>Introduction .....</b>	<b>4</b>
1.1.	Getting Started .....	5
1.1.1.	Quick Start Guide – Summary.....	6
1.1.2.	Unpacking the Camera.....	6
1.1.3.	Parts and Assembly .....	9
1.1.4.	Connections.....	10
1.1.5.	Attaching the camera to a telescope using the 2" nosepiece .....	12
1.1.6.	Attaching the camera to a telescope using a custom adapter.....	12
1.1.7.	Attaching the optional camera lens adapter .....	13
1.1.8.	Connecting the STL-RC Adapter and Relay Cable .....	13
1.1.9.	Optional Relay Adapter Box.....	14
1.1.10.	Attaching the Remote Head .....	14
1.1.11.	Connecting water hoses .....	15
1.1.12.	Extending the USB cable .....	15
1.1.13.	Opening the Front Cover - Changing Filters.....	16
1.1.14.	Regenerating the Desiccant Plug .....	17
1.1.15.	Indicator Lights.....	17
1.1.16.	Opening the Back Cover - Changing the Fuse.....	18
1.1.17.	Attaching the Camera Handles.....	18
1.1.18.	Camera Resolution.....	19
1.1.19.	Camera Field of View .....	20
1.1.20.	Focal Length, Resolution and Field of View .....	21
1.2.	Installing the USB Drivers for the First Time .....	22
1.2.1.	Establish Communications with CCDOPS.....	22
1.2.2.	Capturing Images with the CCD Camera.....	23
<b>2.</b>	<b>Introduction to CCD Cameras.....</b>	<b>25</b>
2.1.	Cameras in General .....	25
2.2.	How CCD Detectors Work.....	25
2.2.1.	Full Frame and Frame Transfer / Interline CCDs.....	26
2.3.	Camera Hardware Architecture .....	26
2.4.	CCD Special Requirements .....	29
2.4.1.	Cooling.....	29
2.4.2.	Double Correlated Sampling Readout .....	29
2.4.3.	Dark Frames .....	30
2.4.4.	Flat Field Images.....	30
2.4.5.	Pixels vs. Film Grains.....	30
2.4.6.	Guiding.....	32
2.5.	Electronic Imaging.....	32
2.6.	Black and White vs. Color .....	33
<b>3.</b>	<b>At the Telescope with a CCD Camera .....</b>	<b>35</b>
3.1.	Step by Step with a CCD Camera.....	35
3.2.	Attaching the Camera to the Telescope.....	35
3.3.	Establishing a Communications Link.....	35
3.4.	Focusing the CCD Camera .....	36
3.5.	Finding and Centering the Object .....	37
3.6.	Taking an Image.....	37

## Section 1 - Introduction

3.7.	Displaying the Image .....	38
3.8.	Processing the Image.....	38
3.9.	Advanced Capabilities .....	38
3.9.1.	Crosshairs Mode (Photometry and Astrometry).....	38
3.9.2.	Sub-Frame Readout in Focus.....	39
3.9.3.	Track and Accumulate.....	39
3.9.4.	Autoguiding and Self Guiding.....	40
3.9.5.	Auto Grab.....	41
3.9.6.	Color Imaging.....	41
<b>4.</b>	<b>Camera Hardware .....</b>	<b>43</b>
4.1.	System Components.....	43
4.2.	Connecting the Power.....	43
4.3.	Connecting to the Computer.....	43
4.4.	Connecting the Relay Port to the Telescope.....	43
4.4.1	Using Mechanical Relays .....	44
4.5.	Modular Family of CCD Cameras.....	46
4.6.	Connecting accessories to the Camera.....	50
4.7.	Battery Operation.....	50
<b>5.</b>	<b>Advanced Imaging Techniques .....</b>	<b>51</b>
5.1.	Lunar and Planetary Imaging.....	51
5.2.	Deep Sky Imaging.....	51
5.3.	Terrestrial Imaging .....	51
5.4.	Taking a Good Flat Field.....	52
5.5.	Building a Library of Dark Frames.....	52
5.6.	Changing the Camera Resolution.....	52
5.7.	Flat Fielding Track and Accumulate Images .....	53
5.8.	Tracking Functions .....	54
<b>6.</b>	<b>Accessories for your CCD Camera .....</b>	<b>57</b>
6.1.	Water Cooling.....	57
6.2.	Tri-color Imaging .....	57
6.3.	Camera Lens Adapter .....	58
6.4.	Focal Reducers.....	58
6.5.	Flat Field Correctors .....	58
6.6.	Third Party Products and Services.....	58
6.6.1.	Windows Software.....	58
6.6.2.	Image Processing Software .....	58
6.6.3.	Getting Hardcopy.....	58
6.7.	SBIG Technical Support .....	59
<b>7.</b>	<b>Common Problems .....</b>	<b>61</b>
<b>8.</b>	<b>Glossary .....</b>	<b>62</b>
<b>A.</b>	<b>Appendix A - Connector and Cables.....</b>	<b>67</b>
A.1.	Connector Pinouts for the AO/SCOPE port:.....	67
A.2.	Connector Pinouts for the power jack: .....	67

## Section 1 - Introduction

A.4.	SBIG Tracking Interface Cable (TIC-78) .....	68
<b>B.</b>	<b>Appendix B - Maintenance .....</b>	<b>69</b>
B.1.	Cleaning the CCD and the Window .....	69
B.2.	Regenerating the Desiccant .....	69
<b>C.</b>	<b>Appendix C - Capturing a Good Flat Field.....</b>	<b>70</b>
C.1.	Technique.....	70
<b>D.</b>	<b>Appendix D - Camera Specifications .....</b>	<b>71</b>
	Model STL-4020M Typical Specificaitons .....	71
	Model STL-11000M Typical Specificaitons .....	72
	Model STL-6303E Typical Specificaitons .....	73
	Model STL-1301E Typical Specificaitons .....	74
	Model STL-1001E Typical Specificaitons .....	75
<b>E.</b>	<b>Appendix E - Third Party Vendors Supporting SBIG Products .....</b>	<b>76</b>
	<b>Index</b>	<b>79</b>

## Section 1 - Introduction

### 1. Introduction

Congratulations and thank you for buying one of Santa Barbara Instrument Group's Research Model CCD cameras. These large format cameras are SBIG's sixth generation CCD cameras and represent the state of the art in CCD camera systems with their low noise and advanced capabilities, including Kodak's new Blue Enhanced E series of CCDs, high speed USB interface, internal filter wheel and dual self-guiding modes. We feel that these cameras will expand your astronomy experience by being able to easily take images like the ones you've seen in books and magazines, of structure never seen through the eyepiece. SBIG CCD cameras offer convenience, high sensitivity, and advanced image processing techniques that film just can't match. And now, with these large format cameras, digital imaging is directly comparable to 35mm film with its wide field of view. In addition, CCDs allow a wide range of scientific measurements and have established a whole new field of amateur astronomy that is growing by leaps and bounds.

The Research Series cameras include several exciting new features: internal self-guiding (US Patent 5,525,793), optional remote self-guiding, internal filter wheel, two-stage cooling, high speed USB interface and more. These cameras have two CCDs inside, one for guiding and a large one for imaging. An optional remote guiding head may be added for guiding through an external optical system or through an off-axis guider placed before the camera. The low noise of the read out electronics virtually guarantees that a usable guide star will be within the field of the guiding CCD for telescopes with F/numbers F/6.3 or faster. The two-stage new cooling design is capable of exceptional performance even in warm climates. The relay output plugs directly into most recent commercial telescope drives and is easily modifiable to virtually any drive system. As a result, you can take hour long guided exposures with ease, using either the built-in guiding CCD or the remote guiding head. The internal guiding CCD eliminates differential deflection of guide scope relative to the main telescope and requires no radial guider setup hassles. The remote guiding head allows for a convenient alternative when imaging through narrow band filters where suitable guide stars may be difficult to find. This dual tracking mode capability, coupled with the phenomenal sensitivity of the CCD, will allow the user to acquire observatory class images of deep sky images with modest apertures! The technology also makes image stabilization possible through our AO-7.

The new Research Series of cameras incorporate the following design features and improvements over predecessors:

- Uses high speed USB for faster downloads with rates up to 425,000 pixels / second.
- Adds a new I2C bi-directional AUX port for future use.
- LEDs on the digital board show relay activations (helpful for troubleshooting).
- New two-stage cooling with water circulation capability built-in.
- No firmware ROM to update, software uploads to camera at boot-up.
- New capabilities can be added to the camera by replacing the loader driver.
- New Boot sequence, LED flashes and fan comes on when firmware upload is complete.
- LED flashes when initializing shutter.
- Mechanical/electronic design work to reduce shutter errors and stray light.
- Larger TC237 autoguider CCD (656 x 495 at 7.4u).
- Premier software, CCDSoftV5 and TheSky included with each camera.
- CCDOPS version 5 camera control software included with major improvements

## Section 1 - Introduction

- Support for USB cameras
- Support for Ethernet (Ethernet to Parallel) for our older parallel cameras
- Read FITS files
- Save in several formats (including ASCII format that imports to Excel).
- Multiple images open at once
- New universal drivers
- Works with all 32-bit Windows OS (95/98/Me/NT/2000/XP).
- Version 5 (Gold Icon) can co-exist with Version 4 (Black Icon).
- Focus Mode Dialog has big numbers for peak brightness to aid focusing.
- Added 1xN, 2xN and 3N readout modes to ST-7/8/9/10/1001
- Magnified preview in crosshairs window
- Sharpen preview in contrast dialog.
- Dockable Icon bar.

### 1.1. Getting Started

**NOTE: The USB driver installation process described in the CCDOPS Manual must be completed by anyone installing an SBIG USB camera for the first time on a particular computer. The USB drivers must be installed on the computer before connecting the camera for the first time. If you wish to run your SBIG USB camera from more than one computer, you must go through the USB driver installation process for each computer you intend to use.**

This manual describes the STL-1001E, STL-1301E, STL-4020M, STL-6303E and STL-11000M CCD Camera Systems from Santa Barbara Instrument Group. This Section contains a one page Quick Start Guide followed by detailed instructions on handling, connecting and maintaining the camera.

For users new to the field of CCD Astronomy, Sections 2, 3 and 4 offer introductory material about CCD Cameras and their applications in Astronomy. Users who are familiar with CCD cameras may wish to skip sections 2 - 4 and go directly to the software manual.

The CCDOPS version 5 manual gives detailed and specific information about the SBIG software. Sections 5 and 6 of this manual offer some basic hints and information about advanced imaging techniques and accessories for CCD imaging that you may wish to read after your initial telescope use of the CCD camera. Finally, section 7 may be helpful if you experience problems with your camera, and the Appendices provide a wealth of technical information about these systems.

## Section 1 - Introduction

### 1.1.1. Quick Start Guide - Summary

#### **Before First Light:**

1. Attach the 2" nosepiece or other adapter to secure the camera to your telescope, or the camera lens adapter if you intend to use a lens rather than a telescope.
2. Attach the handles if desired.
3. Install filters if needed.
4. Install software on the computer(s) that you will use to control the camera.

#### **Before each imaging session, with your computer on and software ready:**

5. Attach the remote guiding head to the camera if you intend to use remote guiding. Do not connect or disconnect the remote head with the power on. If you are unsure it is a good idea to attach it anyway because if you decide to use it in the middle of an observing session you will have to shut down the main camera before connecting the remote head. This could be inconvenient. You can always select the internal guider when the remote head is connected.
6. Attach the STL-RC adapter and relay cable to the camera.
7. Attach the water supply and return tubes and have the water supply and/or pump ready if you intend to use water-cooling.
8. Attach the power to the camera.
9. Attach the USB cable to the camera last. With the camera powered up and the USB cable attached you should see the STAT LED flicker as the camera downloads the drivers from your computer (this is automatic). After a couple of seconds the fan should come on and the STAT LED should glow steady.
10. Referring to your software instructions, use your camera control software to Establish a Communications link between your computer and the camera.

**Your camera is now ready to be controlled by your computer. You should refer to your software manual or instructions for details on focusing, capturing images, taking dark frames, self-guiding, etc.**

### 1.1.2. Unpacking the Camera

It is always a good idea to check over your new camera to make sure that you have received all necessary parts and standard accessories. Each Research Series camera is packed in a deluxe custom carrying case. This case should contain all the items necessary to operate your camera., except for optional color, photometric or narrow band filters which are shipped separately.









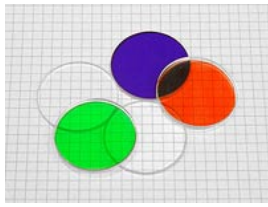

## Section 1 - Introduction

### Standard Equipment for Research Series Cameras:

			
<b>Main Camera Body</b>	<b>Custom 2" Nosepiece</b>	<b>Camera Handles</b>	<b>Internal 2" Filter Carousel</b>
			
<b>Universal Power Supply</b>	<b>Regional AC Cord and Plug</b>	<b>15' USB Cable</b>	<b>Tracking Cable / Adapter</b>
			
<b>Water Tube Connectors</b>	<b>Software and Manuals</b>	<b>Custom Pelican Case</b>	<b>SBIG ASTRONOMICAL INSTRUMENTS</b>

### Optional Equipment for Research Series Cameras:

			
<b>Remote Guiding Head</b>	<b>6' Remote Head Cable</b>	<b>Custom Filters</b>	<b>12V Water Pump</b>
			
<b>Extra Filter Carousel</b>	<b>Nikon Lens Adapter</b>	<b>Relay Adapter Box</b>	<b>12VDC Power Cable</b>

## Section 1 - Introduction

### Standard Items:

**Main Camera Body** - Research Series Camera Body with imaging CCD and built-in and guiding CCD, two-stage cooling, internal filter carousel and high speed USB interface. An accessory plate is fixed to the front of the camera body for attaching nosepiece, camera lens adapter and custom adapters.

**Custom 2" Nosepiece** - Bolt on nosepiece design for minimum vignetting with the largest 35mm format CCD.

**Camera Handles** - Two handles are included for easier handling of the camera in the field.

**Internal 2" Filter Carousel** - An internal 2" filter carousel is built-in to the front cover.

**Universal Power Supply** - This AC supply enables operation of the camera from 90 - 240VAC, 50-60 Hz.

**Regional AC Cord and Plug** - AC cords with either European or North American style plugs are provided.

**15' USB Cable** - A standard 15' USB 1.1 cable is supplied

**Relay Cable and STL-RC Adapter** - The tracking cable is a 6 conductor flat cable with 6 pin modular telephone style plugs at both ends. The STL-RC adapter plug is used to connect the Tracking Cable to the 9 pin port on the camera labeled "AO/SCOPE" for self-guiding.

**Water Tube Connectors** - Two easy snap on/off connectors are provided for connecting water circulation tubes to the camera's water inlet and outlets.

**Software and Manuals** - A complete package of camera control software and manuals are included.

**Custom Pelican Case** - The Pelican brand carrying case provided for the Research Series Cameras are high quality, waterproof, dustproof, crushproof cases that carry a lifetime guarantee from the manufacturer.

### Optional Items:

**Remote guiding head with 3 foot (0.9 meter) head cable** - The optional Remote Guiding Head contains a TC237H CCD identical to the built-in guiding CCD. This head allows you to use a separate guide scope or off-axis guider to place the guiding CCD outside the filter wheel for convenience when imaging through narrow band filters or anytime you wish to use an external guider.

**6 foot (1.8 meter) replacement remote head cable** - Long replacement cable for the 3 foot head cable that is supplied with the Remote Guiding Head.

## Section 1 - Introduction

**Custom Filters** -50mm LRGB, UBVRI and narrow band filters are available. SBIG's LRGB filter set contains both a Luminance and a Clear filter in addition to the RGB filters. The Luminance filter is both UV and IR blocked. The clear filter is not blocked. The RGB passbands have been specifically designed for use with the CCDs used in the Research Series cameras. All filters in the set are AR coated. Our photometric UBVRI filters are also AR coated.

**12V Water Pump** - A submersible pump is available for water cooling. It is only necessary to provide a constant flow of water through the heat exchanger to achieve maximum cooling. Cooling the water supply is not necessary or advised. If you do not have a ready source of water this pump will work in the field from 12VDC.

**Extra Filter Carousel** - If you have more than one set of filters that you change often, it might be easier to keep more than one carousel handy, each with its own set of filters. Then, changing the set requires only swapping the filter carousel.

**Nikon Lens Adapter** - This adapter allows the use of Nikon 35mm camera lenses on Research Series cameras for wide field imaging.

**Relay Adapter Box** - The camera's internal relays used for self-guiding are electronic (TTL) type relays. These work with the vast majority of telescope drive systems today. However, some telescopes, particularly older models, may require mechanical relays to isolate the telescope from the camera. The mechanical relays also provide both normally open and normally closed contacts for custom applications.

**12VDC power cord with cigarette lighter adapter** - A 12VDC power cord is available for field operation directly from a battery.

### 1.1.3. Parts and Assembly

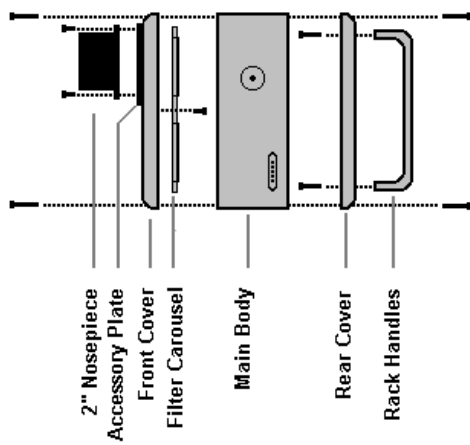

To help you get familiar with the camera and its various parts please refer to the following diagrams and pictures. The large central portion of the camera body contains the CCD chamber, electronics, desiccant plug, shutter, heat exchanger, fan and a power supply allowing 12VDC operation in the field. A separate AC to 12VDC desktop adapter is also provided. The front cover contains the internal filter wheel. A self-aligning connector allows electric signals to pass from the main body to the filter wheel when the front cover is attached to the main body. This allows the user to easily remove the front cover to gain access to the filters and desiccant plug when necessary. The filter wheel will not operate when the front cover is removed from the main body. The front cover also holds the accessory mounting plate on the outside of the aperture over the CCD. The accessory plate is

## Section 1 - Introduction

shimmed at the factory to provide a flat mounting surface that is parallel to the CCD. Under normal use, it should not be removed. The rear cover has ventilation slots for air circulation and also holds the water inlet and outlet connectors. Two clear plastic tubes connect the water inlet and outlet fittings on the rear cover to the heat exchanger inside the back of the main body. There is sufficient tubing to allow the rear cover to be opened to attach the camera handles or to change the fuse located inside the rear of the main body.

### 1.1.4. Connections

For convenience in routing the various cables and connections to the camera, all of the connectors required for power, communication, accessories and water circulation are located together on one side of the camera body.

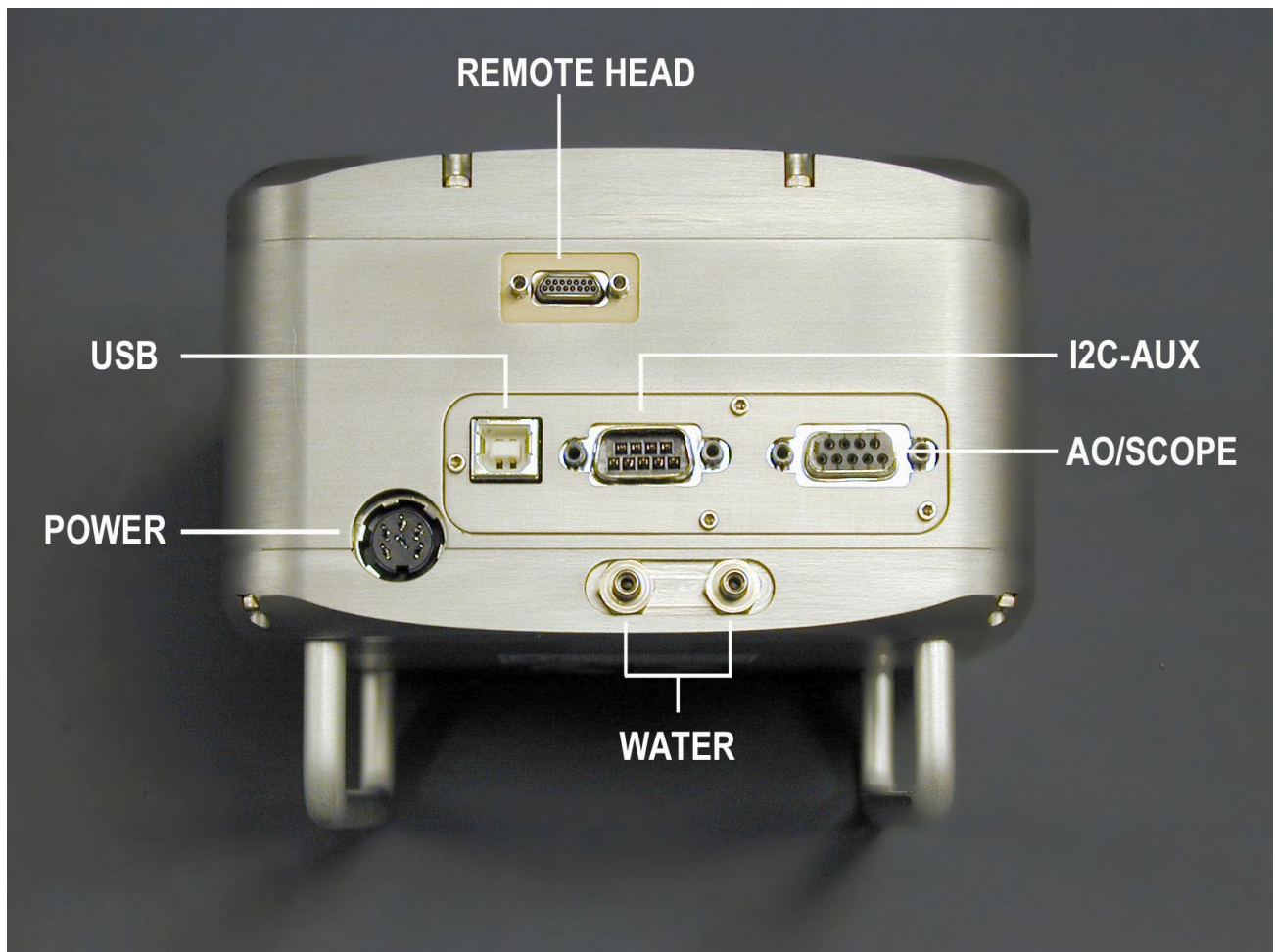

Each of the connections on the bottom of the camera is shown below with a brief explanation of its function.

## Section 1 - Introduction



**POWER** from either the universal AC supply or 12VDC cable is plugged into the round 6 pin DIN connector. If you wish to make a custom power cable, the pin outs for the connector may be found in the appendix of this manual. We recommend 16 gauge conductor for 10' to 15' of cable or 18 gauge conductor for less than 10' of cable. Smaller gauge wire will cause a voltage drop across the cable and the camera may not work properly.



**USB** connection to your computer uses a standard 15' USB cable. If your computer must be more than 15' from the camera we recommend an active extension for short distances (15' additional) or a powered USB extended such as the Icron Ranger for longer distances. The Icron Ranger allows USB devices to operate up to 100 meters from the host computer.



**AO/SCOPE** This port supplies the relay outputs for controlling your telescope during a guiding session. Connect the telephone style cable to this connector by using the supplied STL-RC adapter plug. This connector will also allow control of a future Adaptive Optics device similar to the AO-7. The current AO-7, designed for the ST series of cameras cannot be used on the large format cameras.



**REMOTE HEAD.** This miniature 15 pin connector is for attaching the optional remote guiding head. The remote guiding head contains a cooled TC-237H guiding CCD identical to the guiding CCD built-in the camera. It draws its power from the main camera and is controlled by the same software that controls the internal guider. This option allows the use of either the internal or the remote guiding CCD for self-guiding during long exposures. It has its own shutter for dark frames.



**WATER.** The camera can be operated with or without water circulation. Simply by attaching water circulation you can maintain a lower operating temperature in warm environments. The water circulation helps lower the temperature of the heat exchanger located in the back of the camera and this, in turn, makes it easier for the TE cooler to reach lower temperatures. The water does not need to be cooled. A water pump is optional.

### I2C-AUX

This port (covered in the photos) is not currently used. It is for future expansion of accessories.

## Section 1 - Introduction

### 1.1.5. Attaching the camera to a telescope using the 2" nosepiece

There are several ways to attach the camera to a telescope. The easiest and most practical way is to simply use the supplied custom 2" nosepiece. This

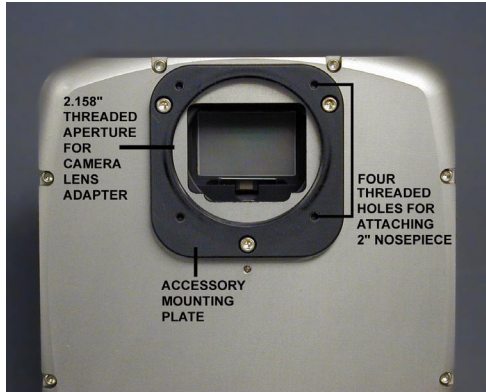

nosepiece is designed to cause minimum vignetting with the largest (35mm format) CCD.

The nosepiece is attached to the accessory plate on the front of the camera with four screws.

This method eliminates the need for a threaded nosepiece that could restrict the light path. The

custom nosepiece is easily attached and removed for transporting the camera in its hard case with the camera handles attached to the camera body.

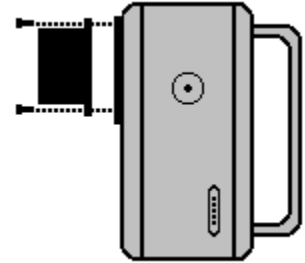

**Caution:** Use only a very solid 2" drawtube, preferably with two or more setscrews holding the camera in place. The camera is large and heavy. Even if it is securely attached at the beginning of an evening, movement and temperature changes could cause the setscrew to come loose and the camera could fall. The best protection is to attach a safety line to the 1/4-20 threaded tripod hole or through one of the camera handles so that even if the camera slips from the telescope or your hands in the cold, it will not fall to the ground or swing into your mount.



### 1.1.6. Attaching the camera to a telescope using a custom adapter

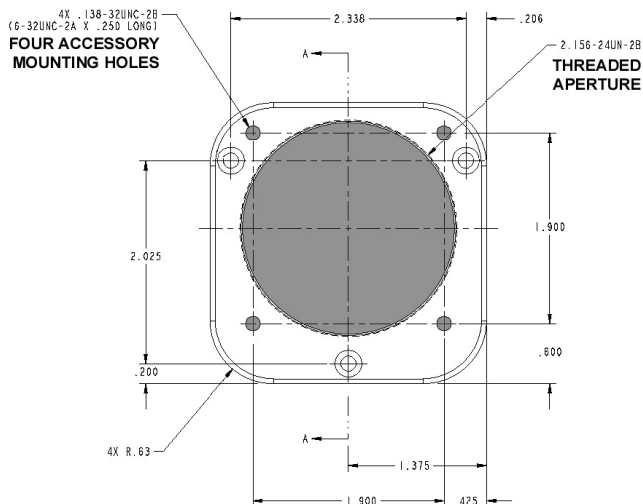

For optical systems that do not offer a 2" drawtube, a custom adapter will have to be provided by the user. The accessory plate on the front cover of the camera has four tapped holes for screw in adapters and the 2.158" aperture is also threaded. In addition to the drawing at left, mechanical drawings in PDF format may be found at the SBIG web site in the Application Notes section.

## Section 1 - Introduction

### 1.1.7. Attaching the optional camera lens adapter

The optional camera lens adapter may be used instead of the 2" nosepiece if you wish to use any Nikon 35mm camera lens to take wide field images with one of the large format cameras. For example, using the popular Nikon 300mm F/2.8 lens on an STL-11000M camera will give a field of view of nearly 5 x 7 degrees. A standard 50mm lens will give a field of view of 28 x 41 degrees! The camera lens adapter is attached to the camera by screwing the threaded barrel of the lens adapter into the large threaded aperture of the accessory mounting plate. A locking ring is provided on the threaded barrel to hold the adapter in place after adjusting it for best focus at infinity.



Nikon 35mm camera lens to take wide field images with one of the large format cameras. For example, using the popular Nikon 300mm F/2.8 lens on an STL-11000M camera will give a field of view of nearly 5 x 7 degrees. A standard 50mm lens will give a field of view of 28 x 41 degrees! The camera lens adapter is attached to the camera by screwing the threaded barrel of the lens adapter into the large threaded aperture of the accessory mounting plate. A locking ring is provided on

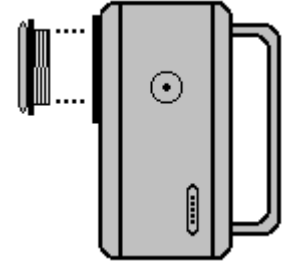

**Caution:** In order to achieve the low profile needed for the Nikon adapter, the small locking pin and release lever have not been used in this adapter design. We have found that the lens fit is snug enough that it will not move by itself once it is screwed into the adapter ring. However, care should be taken that you do not inadvertently rotate the lens in the adapter while adjusting the focus. This will cause a shift in focus and may leave the lens loose in the adapter.



### 1.1.8. Connecting the STL-RC Adapter and Relay Cable

The camera contains internal electronic (TTL) relays used to control a telescope during self-guiding or when auto guiding. Most modern telescope drive controllers have a 6 pin modular phone style jack on their front panel or hand paddle for plugging in an autoguider. The relay outputs from the camera are brought out via a DB9 connector labeled "AO/SCOPE." The same connector will also be used to control an Adaptive Optics device similar to the AO-7 (Note: The AO-7 cannot be used with the Research Series Cameras). To connect the telephone style Relay Cable to the camera, use the STL-RC adapter (shown above) to make the connection between the 6-pin RJ11 plug on the cable and the 9 pin plug on the camera. Plug the other end of the Relay Cable into the CCD or Autoguider port on your telescope's drive corrector.

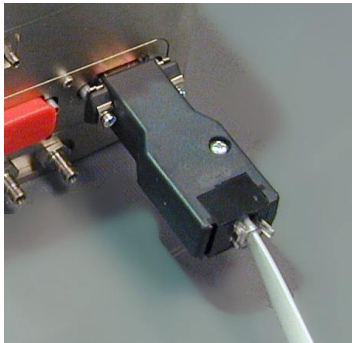

TELESCOPE DRIVE

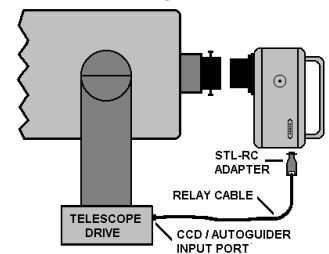

## Section 1 - Introduction

### 1.1.9. Optional Relay Adapter Box

Some older telescope drive correctors require electronic isolation between the camera and the telescope. Other older correctors may require both normally open and normally closed relays. For these and other events, an optional

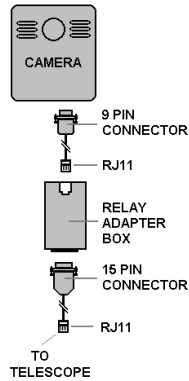

Relay Adapter Box is available that will convert the TTL relay output from the camera to mechanical relays contained in a separate box that is inserted in-line between the camera and the telescope. You must use the 9 pin to RJ11 cable supplied with the Relay Adapter Box to connect the box to the camera. This cable adds a pin that will supply the 12V

needed by the relay adapter box. **DO NOT USE THIS 9 PIN TO RJ11 CABLE TO CONNECT DIRECTLY TO A TELESCOPE.** The telescope may be damaged by the 12 volts on the extra pin. For direct connection to the telescope without the Relay Adapter Box, use the STL-RC adapter plug and RJ11 to RJ11 relay cable as shown in section 1.1.8, above.

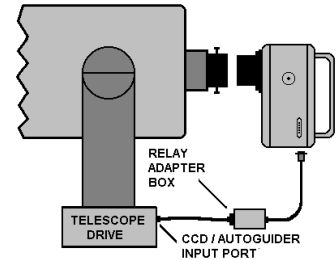

### 1.1.10. Attaching the Remote Head

The Remote Guiding Head is an optional accessory for all models of the Research Series cameras.



When attached to the main camera body using the 3 foot head cable, or the optional 6 foot replacement cable, the Remote Guiding Head can perform all of the functions of the guiding CCD that is built into the camera. You control the Remote Guider using the same menu commands as you would for the internal guider. You can select which guider to use for a self-guided image.

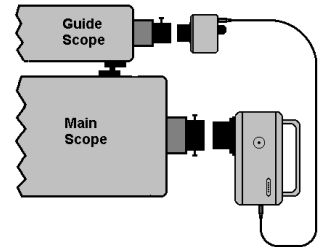

The Remote Guiding Head

makes it possible to self-guide using a separate guide scope, or through an off-axis guider assembly that is placed in front of the filters. This can be useful when imaging through narrow band filters where stars are difficult to see. ***It is important to remember that you should not connect or disconnect the Remote Head to the camera while the power is on.***

It is a

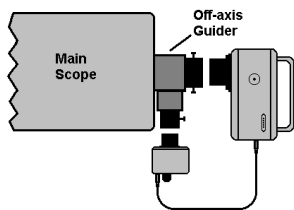

good idea, therefore, to plan your observing session in advance and connect the Remote Head at the beginning of the evening if there is any chance that you expect to use it that night. If you decide that you

need the Remote Head in the middle of an observing session, it may be inconvenient to shut down the main





## Section 1 - Introduction

camera and power back up again. The Remote Guiding Head contains a shutter and TE cooler. It is therefore capable of taking dark frames without manual intervention by the user. The 1.25" nosepiece is screwed into female t-threads on the face plate of the head. The nosepiece may be removed and the head attached to an optical system using t-threads instead. An optional T-to-C adapter is also available that allows the use of c-thread lenses or a C-to-Camera lens adapter such as the CLA5 for attaching 35mm camera lenses.

### 1.1.11. Connecting water hoses

Research Series cameras are equipped with a heat exchanger inside the back cover that allows water circulation if conditions require additional cooling of the CCD. The cameras may be

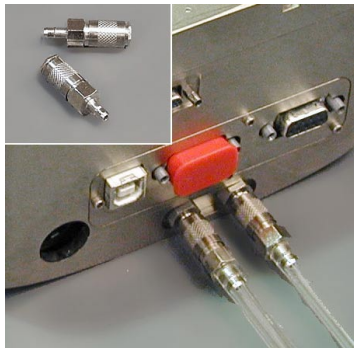

operated with or without water circulation. No special steps are necessary to use water circulation other than connection of a water supply. The camera comes with two water hose fittings (pictured in the inset at left) that snap on and off of the water inlet and outlet fixtures on the bottom of the camera. These fittings accept a hose with an inside diameter of 1/8<sup>th</sup> inch (0.125"/3.2mm). Very little pressure is needed. Only enough pressure to maintain a constant flow is required to get maximum benefit from the water

circulation. Also, it is not necessary to cool the water below ambient temperature with ice or refrigeration. Water at ambient temperature is an effective heat conductor and a constant flow of water will carry away enough heat from the heat exchanger that further cooling of the water supply will result in little gain. In fact, cooling the water supply too much may cool the camera well below the dew point so that moisture forms on the inside surface of the case or the outside surface of the CCD chamber window. If you do not have a way to supply water to the camera, the 12VDC water pump and tubing shown above right is an optional accessory available from SBIG.



### 1.1.12. Extending the USB cable

The camera is supplied a standard 15' (~4.6 meter) USB cable. If you wish to operate the camera remotely, there are several ways to extend this distance between your computer and the camera:

**Active USB Extension Cable.** These accessories are commonly available at computer stores and Radio Shack. They are 15 foot extension cables that get their power from the USB output port of your computer. These are good if your computer is located no more than about 30 feet (~9 meters) from the camera.

**Powered USB extenders.** Powered extenders such as the Icron Ranger ([www.icron.com](http://www.icron.com)) are also commonly available in computer stores and by mail order over the Internet. These extenders require power at one end of the cable (either end) and will let you operate the camera (or any USB device) up to 100 meters from the computer.

**Ethernet (LAN).** SBIG provides server software that allows our USB cameras to be connected to a computer near the camera and operated remotely over a local network (wired or wireless) by another computer on the local network.

## Section 1 - Introduction

### 1.1.13. Opening the Front Cover - Changing Filters

The filter wheel is contained inside the front cover plate. To access the filter wheel remove the eight socket head screws located in recessed slots around the perimeter of the front cover. With the camera lying on its back plate (or on the camera handles if attached), remove the front cover by lifting straight up away from the main body. You will notice resistance as the front cover is still connected to the main body through a self-aligning electrical plug.

This plug will separate and the front cover will come free with a firm but gentle pull. It may be easiest to hold the main body with your hands and push up on the corners of the front cover nearest the connectors with your thumbs. Filters may be inserted and removed with the filter carousel in place. The filter carousel accepts both 48mm threaded filter cells (below right) and 50mm round unmounted filters (below left). Thick unmounted filters may be held in place by turning



the shouldered retaining washers (arrows) upside down to capture the filter. We recommend the 50mm filters for minimum vignetting, particularly with the KAI-11000M CCD. If you have more than one set of filters you may find it easier to purchase one or more additional carousels and populate them with your filter sets. In this case, you

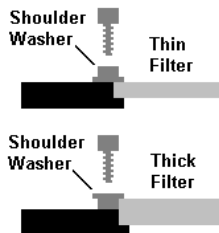

can change sets by swapping carousels. The filter carousel is held in place by a single screw in its center. Remove this screw and carefully remove the carousel by sliding it up and away from the motor. Be careful not to lose the small flat washers that go between the carousel and the front cover. These must be replaced when reassembling the filter wheel to the cover or the carousel will

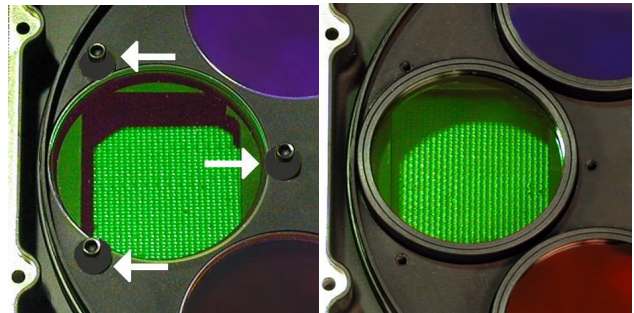

not work properly. After installing or changing filters, replace the carousel taking care to replace the small washer between the carousel and the inside of the front cover. The small steel washer fits into a recessed cutout in the cover, then the larger white Teflon washer goes on top of the steel washer. The carousel is put in place next and the assembly is secured with a screw and Teflon bearing through the center of the filter carousel. **DO NOT OVERTIGHTEN THE CENTRAL SCREW.** It is only necessary to tighten the central screw until it is snug. Over-tightening the screw may impair the operation of the filter wheel. When reassembled, replace the front cover assembly containing the filter carousel on the camera. Orient the front cover so that the self-aligning connector plugs are together and gently push straight towards the main body to seat the front cover. Replace the 8 retaining socket head screws to hold the front cover in place.

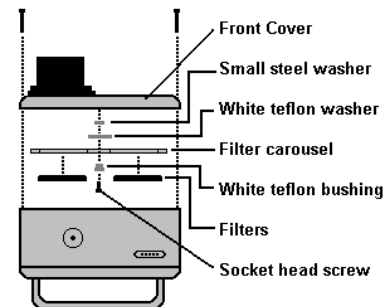

## Section 1 - Introduction

### 1.1.14. Regenerating the Desiccant Plug

The CCD is housed in a sealed chamber located inside the front of the main body. The chamber is separate from the large front and rear cover plates, so that opening the front or rear cover plates to gain access the filter wheel or to attach/remove the camera handles will not expose the CCD chamber to the environment. The CCD chamber has a desiccant plug located on one side to help remove moisture from the air inside the chamber. If it should become necessary to recharge the desiccant due to excess moisture or frosting in the chamber, it is a simple matter to remove the desiccant plug, bake it in a conventional oven at 350 degrees F (175 degrees C) for 4 hours and replace the plug in the camera. To gain access to the desiccant plug, remove the front cover per the instructions for accessing the filter wheel. Note

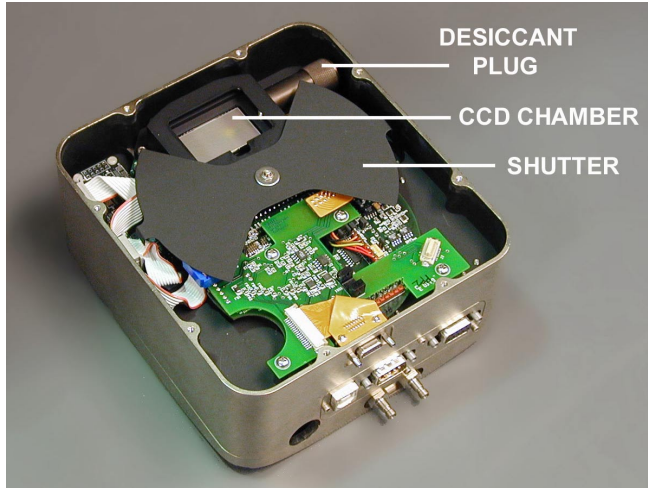

the location of the desiccant plug in the picture. If the shutter is in the way when you open the camera, gently rotate it out of the way by nudging one edge until you have easy access to the desiccant plug. The shutter is thin and flat. Care should be taken not to press directly down on it or bend it in any way. Remove the plug by unscrewing it from the chamber. You should be able to unscrew it using your fingers. If time and temperature have made it too tight, use soft grip pliers to remove it. Be sure to take off the o-ring from around the threads before baking the plug. You may wish to place a small piece of electrical tape over the hole in the side of the CCD chamber while you are baking the desiccant plug to keep unwanted dust and moisture out of the chamber. When you replace the desiccant plug after baking it, do not over-tighten it when you screw it back into the chamber. It should be tightened as much as you can with your fingers only. Don't forget to replace the o-ring on the plug before re-installing it after baking.

the location of the desiccant plug in the picture. If the shutter is in the way when you open the camera, gently rotate it out of the way by nudging one edge until you have easy access to the desiccant plug. The shutter is thin and flat. Care should be taken not to press directly down on it or bend it in any way. Remove the plug by unscrewing it from the chamber. You should be able to unscrew it using your fingers. If time and temperature have made it too tight, use soft grip pliers to remove it. Be sure to take off the o-ring from around the threads before baking the plug. You may wish to place a small piece of electrical tape over the hole in the side of the CCD chamber while you are baking the desiccant plug to keep unwanted dust and moisture out of the chamber. When you replace the desiccant plug after baking it, do not over-tighten it when you screw it back into the chamber. It should be tightened as much as you can with your fingers only. Don't forget to replace the o-ring on the plug before re-installing it after baking.

### 1.1.15. Indicator Lights

There are five LED indicator lights located on the side of the main camera body that provide information about the camera's communication link, exposure status, internal temperature and input voltage. The green status LED labeled STAT will flicker when the camera is initializing after being connected to the computer. It will then either glow continuously when the camera is idle or blink when the camera is taking an exposure. The red LED labeled HOT will light if the temperature of the camera's heat exchanger exceeds 50 degrees C. In this case the camera will automatically reduce the power to the TE cooler. The first yellow LED labeled 11V will light if the input voltage at the camera drops to 11V or less. The second yellow LED labeled 10V will light if the input voltage at the camera drops to 10V or less. The final red LED labeled 9V will light if the input voltage at the camera drops to 9V or less. If the voltage drops to 11V or 10V the camera will continue to operate normally. However, once the input voltage drops to 9

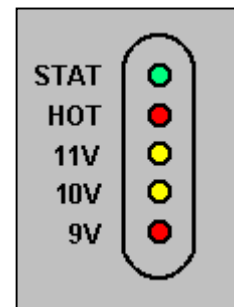

## Section 1 - Introduction

volts or less the camera will shut down the cooling and continue to attempt to operate until the voltage drops to a point (about 7 - 8 volts) where the camera is no longer able to function normally.

### 1.1.16. Opening the Back Cover - Changing the Fuse

Research Series cameras have a built-in regulated 12VDC power supply which lets you run the camera directly from any 12VDC source such as a car battery. The input to this supply is protected with a fuse located inside the rear of the camera. To access the fuse, remove the back cover plate of the camera by removing the four socket head screws located in recessed slots at the four corners of the rear of the camera. Carefully lift the rear cover and stand it near the heat exchanger as shown in the picture below. There are two flexible tubes running from the water inlet and outlet fixtures on the back cover to the heat exchanger that prevent the rear cover from being completely separated from the main body. However, the cover can be opened for



routine access to the fuse and camera handles without removing these tubes.

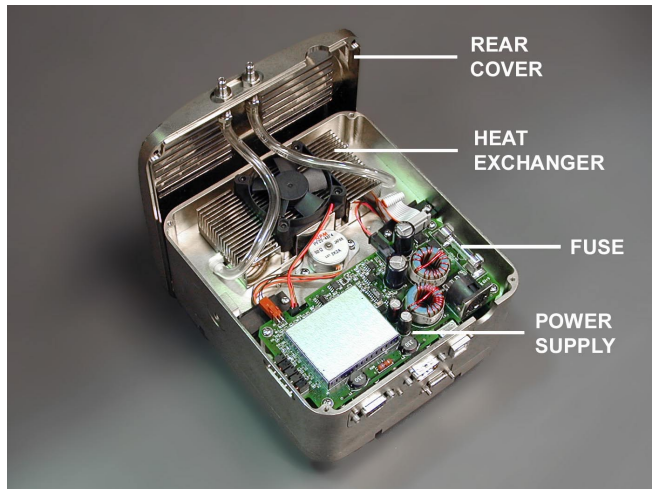

**WARNING:** It is recommended that you do not detach the water circulation tubes inside the camera. It is not easy to tell if they are connected once the back cover is replaced. If they are accidentally left detached inside the camera when a water source is connected to the fixtures on the outside of the camera body, the water will leak into the camera body and damage or destroy the electronics.

### 1.1.17. Attaching the Camera Handles

Two handles are supplied with each Research Series camera to make it easier to handle in the field. These

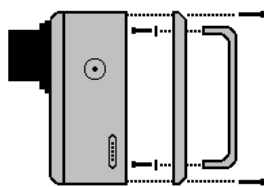

handles may be attached or left off as you see fit. If you wish to attach the handles, open the back cover of the camera and pass the screws with washers for the handles through the holes in the back cover. Once

the handles are secured, re-attach the back cover.



**Note that the camera will fit in its carrying case with either the camera handles or the 2" nosepiece attached, but not both. However, the 2" nosepiece is easily attached and detached from the accessory plate for transportation with four external screws.**

## Section 1 - Introduction

### 1.1.18. Camera Resolution

Resolution comes in two flavors these days. In the commercial world of digital devices, the word resolution is often used synonymously with the number of pixels used in a device. You are used to seeing ads for scanners with a "resolution" of 2,000 x 3,000 pixels, etc. Computer monitors have various "resolution" settings which are basically the number of pixels displayed. We use the word here in its literal sense, which is ability to resolve detail. This has nothing to do with the number of

FL INCHES	Pixel Size in Microns						FL MM
	7.4	9	14.8	16	18	24	
20	3.00	3.65	6.01	6.50	7.31	9.74	500
40	1.50	1.83	3.00	3.25	3.65	4.87	1000
60	1.00	1.22	2.00	2.17	2.44	3.25	1500
80	0.75	0.91	1.50	1.62	1.83	2.44	2000
100	0.60	0.73	1.20	1.30	1.46	1.95	2500
120	0.50	0.61	1.00	1.08	1.22	1.62	3000
140	0.43	0.52	0.86	0.93	1.04	1.39	3600
160	0.38	0.46	0.75	0.81	0.91	1.22	4100
180	0.33	0.41	0.67	0.72	0.81	1.08	4600
200	0.30	0.37	0.60	0.65	0.73	0.97	5100
220	0.27	0.33	0.55	0.59	0.66	0.89	5600
240	0.25	0.30	0.50	0.54	0.61	0.81	6100
260	0.23	0.28	0.46	0.50	0.56	0.75	6600
280	0.21	0.26	0.43	0.46	0.52	0.70	7100
300	0.20	0.24	0.40	0.43	0.49	0.65	7600
320	0.19	0.23	0.38	0.41	0.46	0.61	8100
340	0.18	0.21	0.35	0.38	0.43	0.57	8600
360	0.17	0.20	0.33	0.36	0.41	0.54	9100
380	0.16	0.19	0.32	0.34	0.38	0.51	9700
400	0.15	0.18	0.30	0.32	0.37	0.49	10200

Pixel field of view in arcsec

pixels, rather it is governed by the size of each pixel and the focal length of the optical system. Typically, seeing limits the resolution of a good system. Seeing is often measured in terms of the Full Width Half Maximum (FWHM) of a star image on a long exposure. That is, the size of a star's image in arcseconds when measured at half the maximum value for that star in an exposure of many seconds. As a general rule, one wants to sample such a star image with no less than 2 pixels. It is preferable to sample the star image with 3 or more pixels depending on the processing steps to be performed and the final display size desired. By way of example, if the atmosphere and optical system allow the smallest star images of 2.6 arcseconds in diameter (FWHM) then one needs a telescope focal length and pixel size that will let each pixel see 1/3 of 2.6 arcseconds. In this example the pixel field of view should be about 0.86

arcseconds per pixel for an optimum balance of extended object sensitivity to resolution of fine detail. If you aim for a pixel FOV of about 1 arcsecond per pixel through a given focal length, then you should be fine for the majority of typical sites and imaging requirements. If your seeing is much better than typical, then you should aim for less than one arcsecond per pixel. If your seeing is much worse than typical, then you can get away with 1.5 or even 2 arcseconds per pixel. The table at left shows the field of view per pixel for each of our cameras at various focal lengths. Select the focal length or range of focal lengths of your telescope(s) and look across for a pixel size that yields a field of view close to 1 arcsecond per pixel. Note also that the exception to this rule is planetary imaging where sensitivity is not an issue and resolution is paramount. In this case, aim for 0.5 or 0.25 arcseconds per pixel. Also note that cameras with smaller pixels may be binned 2x2 or 3x3 to create larger pixels and expand the useful range of the camera. For example, an ST-4020M with 7.4 micron pixels can be binned 2x2 to give 14.8 micron pixels. The overall field of view of the CCD does not change however, and a camera with larger pixels and a larger field of view might be preferable if it will not be used on shorter focal length instruments.

## Section 1 - Introduction

### 1.1.19. Camera Field of View

The field of view that your camera will see through a given telescope is determined by the focal length of the telescope and the physical size of the CCD chip. This also has nothing to do with the number of pixels. Through the same telescope, a CCD that has 512 x 512 pixels at 20 microns square will have exactly the same field of view as a CCD with 1024 x 1024 pixels at 10 microns square even though the latter has four times as many pixels. One can vary the focal length to vary the field of view. Using a focal reducer to shorten the focal length will increase the field of view (and make the image brighter in the process). Using a barlow or eyepiece projection to effectively lengthen the focal length of the telescope will decrease the field of view (and make the image dimmer in the process). In order to determine the field of view for a given CCD, note the CCD's length and width dimensions in millimeters (from the camera specifications) and use the following formula for determining the field of view for that CCD through any telescope:

FOCAL LENGTH IN INCHES	4020 CCD FOV min	1302 CCD FOV min	6303 CCD FOV min	1001 CCD FOV min	11000 CCD FOV min	FOCAL LENGTH IN MM
20	145	177	224	235	294	500
40	72	89	112	118	147	1000
60	48	59	75	78	98	1500
80	36	44	56	59	74	2000
100	29	35	45	47	59	2500
120	24	30	37	39	49	3000
140	21	25	32	34	42	3600
160	18	22	28	29	37	4100
180	16	20	25	26	33	4600
200	14	18	22	24	29	5100
220	13	16	20	21	27	5600
240	12	15	19	20	25	6100
260	11	14	17	18	23	6600
280	10	13	16	17	21	7100
300	10	12	15	16	20	7600
320	9	11	14	15	18	8100
340	9	10	13	14	17	8600
360	8	10	12	13	16	9100
380	8	9	12	12	15	9700
400	7	9	11	12	15	10200

CCD field of view in arcmin

$$(135.3 \times D) / L = \text{Field of View in arcminutes}$$

where **D** is the length or width dimension of the CCD in millimeters, and **L** is the focal length of your telescope in inches. So, for example, if you wanted to know the field of view of the new STL-

Object	Approximate Angular Size
NGC7000. N. American Nebula	175 x 110 arcmin
M31. Andromeda Galaxy	190 x 60 arcmin
M42. Orion Nebula	85 x 60 arcmin
Disk. Sun / Moon	30 x 30 arcmin
M101. Face on spiral galaxy	22 x 22 arcmin
M13. Globular Cluster	6.6 x 6.6 arcmin
M104. Sombrero Galaxy	9 x 4 arcmin
M27. Dumbbell Nebula	8 x 5.7 arcmin
M57. Ring Nebula	1.4 x 1 arcmin
Jupiter	40 arcseconds

4020M camera when attached to a 5" F/6 telescope you would first determine the focal length of the telescope by multiplying its aperture, 5 inches, by its focal ratio, 6, to get its focal length, 30 inches. The CCD dimensions are 15.2 x 15.2 mm. To calculate the field of view multiply 135.3 x 15.2 = 2,057 and then divide by 30 = 68.6 arcminutes. By way of comparison, the field of view of the longest dimension of the STL-11000M through the same telescope would be 135.3 x 36 = 4,871 divided by 30 = 162.4 arcminutes. The table above shows the calculated field of view in arcminutes for each of the large format CCDs at various focal lengths. Keep in mind however that when you vary the CCD field of view you are also varying the field of view for each pixel and are therefore also affecting the resolution of your system.

## Section 1 - Introduction

### 1.1.20. Focal Length, Resolution and Field of View

From the forgoing we see that neither resolution alone, nor field of view alone, are dependent solely on the number of pixels of a sensor. So when are more pixels better? The key word in the first sentence is “alone.” If all other factors are equal, more pixels will yield a larger field of view compared to another camera with fewer pixels of the same size. The STL-6303 and the STL-11000 both have CCDs with 9 micron pixels. The resolution will be the same through any optical system. However, the STL-11000 has more pixels and therefore at a given resolution it will have a larger field of view. To see how these various factors are affected by varying the focal length of the optical system, use the chart below. This chart shows both pixel field of view and the resulting CCD field of view at given focal lengths for each of the Research Series cameras

FOCAL LENGTH IN INCHES	4020		11000		6303		1302		1001		FOCAL LENGTH IN MM
	CCD FOV min	PIXEL FOV sec	CCD FOV min	PIXEL FOV sec	CCD FOV min	PIXEL FOV sec	CCD FOV min	PIXEL FOV sec	CCD FOV min	PIXEL FOV sec	
20	144.8	3.00	294.3	3.65	223.9	3.65	177.2	6.50	235.4	9.74	500
40	72.4	1.50	147.1	1.83	112.0	1.83	88.6	3.25	117.7	4.87	1000
60	48.3	1.00	98.1	1.22	74.6	1.22	59.1	2.17	78.5	3.25	1500
80	36.2	0.75	73.6	0.91	56.0	0.91	44.3	1.62	58.9	2.44	2000
100	29.0	0.60	58.9	0.73	44.8	0.73	35.4	1.30	47.1	1.95	2500
120	24.1	0.50	49.0	0.61	37.3	0.61	29.5	1.08	39.2	1.62	3000
140	20.7	0.43	42.0	0.52	32.0	0.52	25.3	0.93	33.6	1.39	3600
160	18.1	0.38	36.8	0.46	28.0	0.46	22.2	0.81	29.4	1.22	4100
180	16.1	0.33	32.7	0.41	24.9	0.41	19.7	0.72	26.2	1.08	4600
200	14.5	0.30	29.4	0.37	22.4	0.37	17.7	0.65	23.5	0.97	5100
220	13.2	0.27	26.8	0.33	20.4	0.33	16.1	0.59	21.4	0.89	5600
240	12.1	0.25	24.5	0.30	18.7	0.30	14.8	0.54	19.6	0.81	6100
260	11.1	0.23	22.6	0.28	17.2	0.28	13.6	0.50	18.1	0.75	6600
280	10.3	0.21	21.0	0.26	16.0	0.26	12.7	0.46	16.8	0.70	7100
300	9.7	0.20	19.6	0.24	14.9	0.24	11.8	0.43	15.7	0.65	7600
320	9.0	0.19	18.4	0.23	14.0	0.23	11.1	0.41	14.7	0.61	8100
340	8.5	0.18	17.3	0.21	13.2	0.21	10.4	0.38	13.8	0.57	8600
360	8.0	0.17	16.3	0.20	12.4	0.20	9.8	0.36	13.1	0.54	9100
380	7.6	0.16	15.5	0.19	11.8	0.19	9.3	0.34	12.4	0.51	9700
400	7.2	0.15	14.7	0.18	11.2	0.18	8.9	0.32	11.8	0.49	10200
420	6.9	0.14	14.0	0.17	10.7	0.17	8.4	0.31	11.2	0.46	10700
440	6.6	0.14	13.4	0.17	10.2	0.17	8.1	0.30	10.7	0.44	11200
460	6.3	0.13	12.8	0.16	9.7	0.16	7.7	0.28	10.2	0.42	11700
480	6.0	0.13	12.3	0.15	9.3	0.15	7.4	0.27	9.8	0.41	12200
500	5.8	0.12	11.8	0.15	9.0	0.15	7.1	0.26	9.4	0.39	12700
520	5.6	0.12	11.3	0.14	8.6	0.14	6.8	0.25	9.1	0.37	13200
540	5.4	0.11	10.9	0.14	8.3	0.14	6.6	0.24	8.7	0.36	13700
560	5.2	0.11	10.5	0.13	8.0	0.13	6.3	0.23	8.4	0.35	14200
580	5.0	0.10	10.1	0.13	7.7	0.13	6.1	0.22	8.1	0.34	14700
600	4.8	0.10	9.8	0.12	7.5	0.12	5.9	0.22	7.8	0.32	15200
620	4.7	0.10	9.5	0.12	7.2	0.12	5.7	0.21	7.6	0.31	15700
640	4.5	0.09	9.2	0.11	7.0	0.11	5.5	0.20	7.4	0.30	16300
660	4.4	0.09	8.9	0.11	6.8	0.11	5.4	0.20	7.1	0.30	16800
680	4.3	0.09	8.7	0.11	6.6	0.11	5.2	0.19	6.9	0.29	17300
700	4.1	0.09	8.4	0.10	6.4	0.10	5.1	0.19	6.7	0.28	17800
720	4.0	0.08	8.2	0.10	6.2	0.10	4.9	0.18	6.5	0.27	18300
740	3.9	0.08	8.0	0.10	6.1	0.10	4.8	0.18	6.4	0.26	18800
760	3.8	0.08	7.7	0.10	5.9	0.10	4.7	0.17	6.2	0.26	19300
780	3.7	0.08	7.5	0.09	5.7	0.09	4.5	0.17	6.0	0.25	19800
800	3.6	0.08	7.4	0.09	5.6	0.09	4.4	0.16	5.9	0.24	20300

## Section 1 - Introduction

### 1.2. Installing the USB Drivers for the First Time

If you are installing an SBIG USB camera for the first time you must install the USB drivers BEFORE attempting to connect the camera to the computer. This is true for each computer you intend to use to control the camera. Please refer to the CCDOPS manual for instructions on installing the USB drivers and camera control software.

#### 1.2.1. Establish Communications with CCDOPS

Once you have installed the USB drivers and CCDOPS control software on your computer, you can connect the camera to the USB port and establish a communications link. If you are using software other than CCDOPS please refer to the instructions for your particular software package.

With CCDOPS software, you must first select USB as the communications mode in the **Misc** menu. Select **Misc**, then **Graphics/Comm Setup...**

After you click on the menu item you will see a Graphics/Comm Setup dialog box as shown below. Pick USB as the Interface from the drop down list of interface items. Then click OK.

CCDOPS will remember the interface setup the next time you use the program so this step only needs to be done the first time you use the program unless you change the

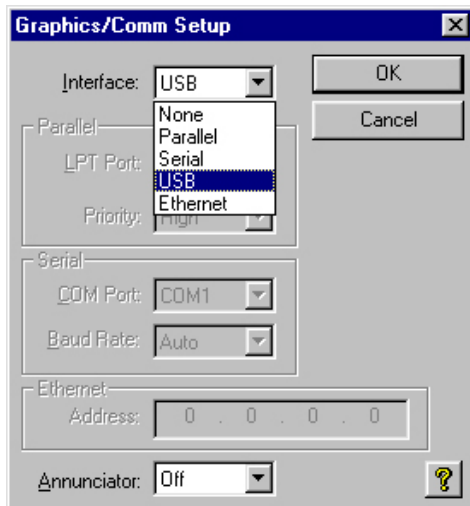
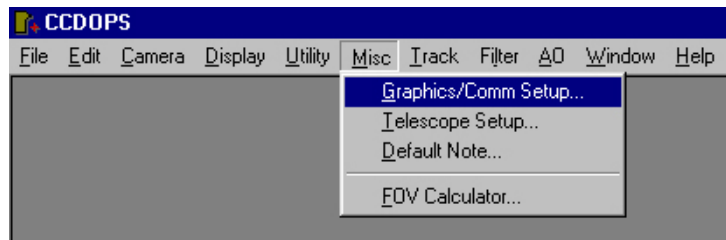

interface type for a different camera. If you re-install CCDOPS for any reason, be sure to re-set this item. After you have selected USB as the interface, establish communication with the camera. Select the **Camera** menu and click on **Establish Com Link**. After a few seconds should see "Link:[STxxx]USB" in lower-right corner of CCDOPS main window where STxxx is the camera model. You are now talking to the camera. From this point you should follow the software instructions in the

CCDOPS manual to Set Up the camera's cooling, Focus, Grab images, etc. You must establish a comm link with the camera each time you connect it to the computer.

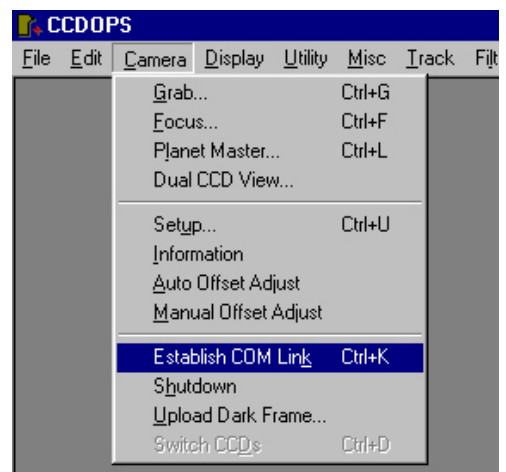



## Section 1 - Introduction

### 1.2.2. Capturing Images with the CCD Camera

Unfortunately there really aren't many shortcuts you can take when using the CCD camera to capture images. Refer to your software manual for detailed instructions. However, to begin we suggest:

- Find some relatively bright object like M51, the Ring Nebula (M57) or the Dumbbell Nebula
- Take a 1 minute exposure using the Grab command with the Dark frame option set to Also
- Display the image.
- Process the image.

If you happen to have purchased a camera lens adapter for your CCD Camera you can use that to take images in the daytime. Be aware that these cameras are extremely sensitive and will saturate in the shortest exposure times when imaging in daylight conditions if steps are not taken to attenuate the amount of light reaching the CCD. If you are testing the camera with a lens during the daytime, the tests should be performed in a darkened room with the lens aperture set to about f/16.



### 2. Introduction to CCD Cameras

This section introduces new users to CCD (Charge Coupled Device) cameras and their capabilities and to the field of CCD Astronomy and Electronic Imaging.

#### 2.1. Cameras in General

The CCD is very good at the most difficult astronomical imaging problem: imaging small, faint objects. For such scenes long film exposures are typically required. The CCD based system has several advantages over film: greater speed, quantitative accuracy, ability to increase contrast and subtract sky background with a few keystrokes, the ability to co-add multiple images without tedious dark room operations, wider spectral range, and instant examination of the images at the telescope for quality. Film has the advantages of a variety of larger formats such as 6x7, color, and independence of the wall plug (the SBIG family of cameras can be battery operated in conjunction with a laptop computer, though). After some use you will find that film is somewhat easier to use for producing sensational large area color pictures, but the CCD is better for planets, galaxies and other faint objects, and general scientific work such as variable star monitoring and position determination.

#### 2.2. How CCD Detectors Work

The basic function of the CCD detector is to convert an incoming photon of light to an electron which is stored in the detector until it is read out, thus producing data which your computer can display as an image. It doesn't have to be displayed as an image. It could just as well be displayed as a spreadsheet with groups of numbers in each cell representing the number of electrons produced at each pixel. These numbers are displayed by your computer as shades of gray for each pixel site on your screen thus producing the image you see. How this is accomplished is eloquently described in a paper by James Janesick and Tom Elliott of the Jet Propulsion Laboratory:

"Imagine an array of buckets covering a field. After a rainstorm, the buckets are sent by conveyor belts to a metering station where the amount of water in each bucket is measured. Then a computer would take these data and display a picture of how much rain fell on each part of the field. In a CCD the "raindrops" are photons, the "buckets" the pixels, the "conveyor belts" the CCD shift registers and the "metering system" an on-chip amplifier.

Technically speaking the CCD must perform four tasks in generating an image. These functions are 1) charge generation, 2) charge collection, 3) charge transfer, and 4) charge detection. The first operation relies on a physical process known as the photoelectric effect - when photons or particles strikes certain materials free electrons are liberated...In the second step the photoelectrons are collected in the nearest discrete collecting sites or pixels. The collection sites are defined by an array of electrodes, called gates, formed on the CCD. The third operation, charge transfer, is accomplished by manipulating the voltage on the gates in a systematic way so the signal electrons move down the vertical registers from one pixel to the next in a conveyor-belt like fashion. At the end of each column is a horizontal register of pixels. This register collects a line at a time and then

## Section 2 - Introduction to CCD Cameras

transports the charge packets in a serial manner to an on-chip amplifier. The final operating step, charge detection, is when individual charge packets are converted to an output voltage. The voltage for each pixel can be amplified off-chip and digitally encoded and stored in a computer to be reconstructed and displayed on a television monitor.<sup>1</sup>

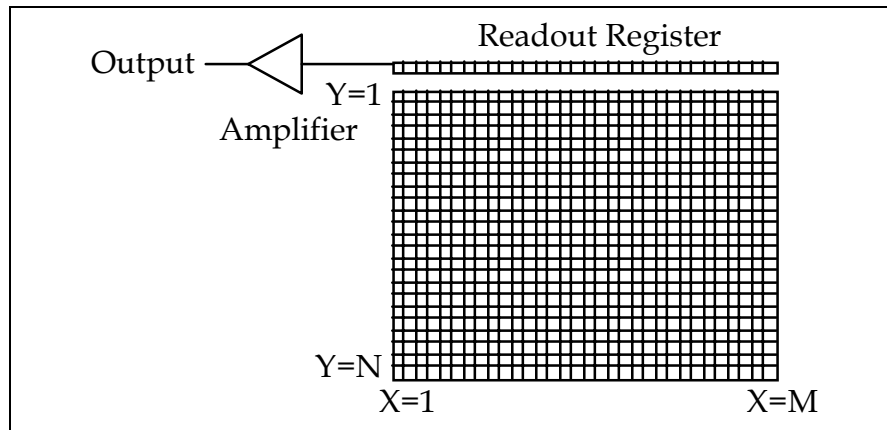

Figure 2.1 - CCD Structure

### 2.2.1. Full Frame and Frame Transfer / Interline CCDs

In the STL-1301E, STL-1001E and STL-6303E, the CCD is read out electronically by shifting each row of pixels into a readout register at the  $Y=0$  position of the CCD (shown in Figure 2.1), and then shifting the row out through an amplifier at the  $X=0$  position. The entire array shifts up one row when a row is shifted into the readout register, and a blank row is inserted at the bottom. The electromechanical shutter built into the camera covers the CCD during the readout to prevent streaking of the image. Without a shutter the image would be streaked due to the fact that the pixels continue to collect light as they are being shifted out towards the readout register. CCDs with a single active area are called Full Frame CCDs.

For reference, the TC-237 guiding CCD uses a different type of CCD, which is known as a Frame Transfer CCD. In these devices all active pixels are shifted very quickly into a pixel array screened from the light by a metal layer, and then read out. This makes it possible to take virtually streak-free images without a shutter. This feature is typically called an *electronic shutter*. The interline CCD used in the STL-4020M and STL-11000M is similar to a frame transfer except that the protected pixels are interlaced with the active pixels.

### 2.3. Camera Hardware Architecture

This section describes the STL-4020M, STL-1301E, STL-1001E, STL-11000M and STL-6303E CCD cameras from a systems standpoint. It describes the elements that comprise a CCD camera and the functions they provide. Please refer to Figure 2.2 below as you read through this section.

---

<sup>1</sup> "History and Advancements of Large Area Array Scientific CCD Imagers", James Janesick, Tom Elliott. Jet Propulsion Laboratory, California Institute of Technology, CCD Advanced Development Group.

## Section 2 - Introduction to CCD Cameras

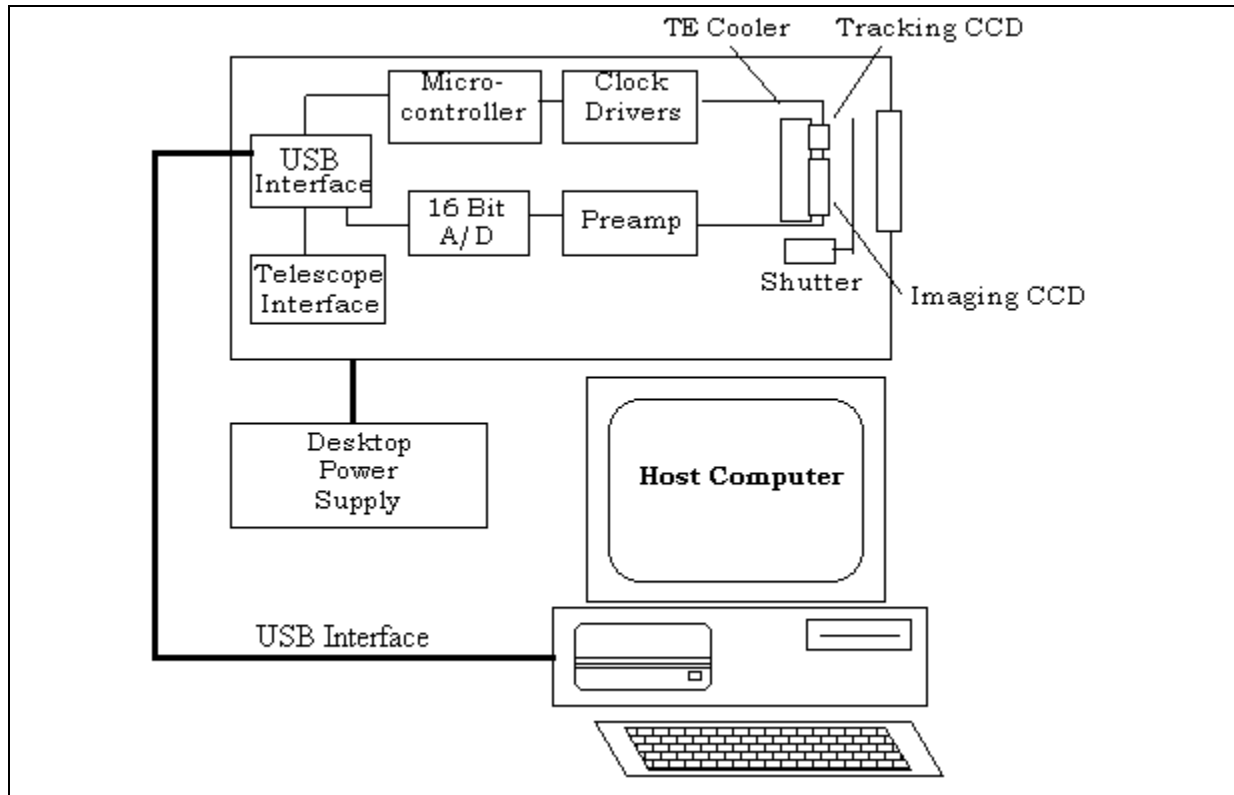

Figure 2.2 - CCD System Block Diagram

As you can see from Figure 2.2, the cameras are completely self-contained. All the electronics are contained in the optical head. There is no external CPU.

At the "front end" of any CCD camera is the CCD sensor itself. As we have already learned, CCDs are a solid-state image sensor organized in a rectangular array of regularly spaced rows and columns. The Research Series of cameras use two CCDs, one for imaging (Kodak KAF series) and one for tracking (TC237). An optional remote guiding head contains another CCD used for tracking (TC237).

## Section 2 - Introduction to CCD Cameras

Table 2.1 below lists some interesting aspects of the CCDs used in the Research models of SBIG cameras.

Camera	CCD	Array Dimensions	Number of Pixels	Array	Pixel Sizes
STL-4020M	KAI-4020M	15.2 x 15.2 mm	4.2 million	2048 x 2048	7.4 x 7.4 $\mu$
STL-1301E	KAF-1301E	20.5 x 16.4 mm	1.3 million	1280 x 1024	16 x 16 $\mu$
STL-1001E	KAF-1001E	24.6 x 24.6 mm	1.0 million	1024 x 1024	24 x 24 $\mu$
STL-6303E	KAF-6303E	27.6 x 18.4 mm	6.3 million	3072 x 2048	9 x 9 $\mu$
STL-11000M	KAI-11000M	36.1 x 24.7 mm	11 million	4008 x 2745	9 x 9 $\mu$
TC237 Tracking CCD	TC-237H	4.9 x 3.7 mm	325 thousand	657 x 495	7.4 x 7.4 $\mu$

*Table 2.1 - Camera CCD Configurations*

The CCD is cooled with a solid-state two-stage thermoelectric (TE) cooler. The TE cooler pumps heat out of the CCD and dissipates it into a heat sink, which forms part of the optical head's mechanical housing. In the Research Series cameras this waste heat is dumped into the air using a heat exchanger and a small fan. The heat exchanger is also capable of water circulation for additional efficiency if needed in hot climates. An inlet and outlet are provided on the bottom of the camera head for passing water through the heat exchanger. Only a very small flow is required and an ordinary aquarium pump is sufficient if it will pull the flow up the length of tubing you might require at your installation. An optional 110VAC pump and tubing are also available from SBIG.

Since the CCD is cooled below 0°C, some provision must be made to prevent frost from forming on the CCD. The Research Series cameras have the CCD/TE Cooler mounted in a windowed hermetic chamber sealed with an O-Ring. The hermetic chamber does not need to be evacuated, another "ease of use" feature we employ in the design of our cameras. Using a rechargeable desiccant in the chamber keeps the humidity low, forcing the dew point below the cold stage temperature.

Other elements in the self contained Research Series cameras include the preamplifier and an electromechanical shutter. The shutter makes taking dark frames a simple matter of pushing a button on the computer and provides streak-free readout. Timing of exposures in Research Series cameras is controlled by this shutter.

The Clock Drivers and Analog to Digital Converter interface to the CCD. The Clock Drivers convert the logic-level signals from the micro controller to the voltage levels and sequences required by the CCD. Clocking the CCD transfers charge in the array and is used to clear the array or read it out. The Analog to Digital Converter (A/D) digitizes the data in the CCD for storage in the Host Computer.

The micro controller is used to regulate the CCD's temperature by varying the drive to the TE cooler. The external Power Supply provides +5V and  $\pm 12$ V to the cameras. Finally, the cameras contain a TTL level telescope interface port to control the telescope and the internal motorized filter wheel.

Although not part of the CCD Camera itself, the Host Computer and Software are an integral part of the system. SBIG provides software for the Research Series cameras for the IBM PC and Compatible computers running Windows 95/98/2000/Me/NT/XP. The software allows image acquisition, image processing, and auto guiding with ease of use and professional

## Section 2 - Introduction to CCD Cameras

quality. Many man-years and much customer feedback have gone into the SBIG software and it is unmatched in its capabilities.

### 2.4. CCD Special Requirements

This section describes the unique features of CCD cameras and the special requirements that CCD systems impose.

#### 2.4.1. Cooling

Random readout noise and noise due to dark current combine to place a lower limit on the ability of the CCD to detect faint light sources. SBIG has optimized the Research Series cameras to achieve readout noises below 20 electrons rms for two reads (light - dark). Typically the read noise is 15 electrons or less. This will not limit most users. The noise due to the dark current is equal to the square root of the number of electrons accumulated during the integration time. For these cameras, the dark current is not significant until it accumulates to more than 280 electrons. Dark current is thermally generated in the device itself, and can be reduced by cooling. All CCDs have dark current, which can cause each pixel to fill with electrons in only a few seconds at room temperature even in the absence of light. By cooling the CCD, the dark current and corresponding noise is reduced, and longer exposures are possible. In fact, for roughly every 6° C of additional cooling, the dark current in the CCD is reduced to half. Each Research Series camera has a two-stage TE cooler, efficient heat exchanger and water circulation capability. A temperature sensing thermistor on the CCD mount monitors the temperature. The micro controller controls the temperature at a user-determined value for long periods. As a result, exposures hours long are possible, and saturation of the CCD by the sky background typically limits the exposure time.

The sky background conditions also increase the noise in images, and in fact, as far as the CCD is concerned, there is no difference between the noise caused by dark current and that from sky background. If your sky conditions are causing photoelectrons to be generated at the rate of 100 e<sup>-</sup>/pixel/sec, for example, increasing the cooling beyond the point where the dark current is roughly half that amount will not improve the quality of the image. This very reason is why deep sky filters are so popular with astrophotography. They reduce the sky background level, increasing the contrast of dim objects. They will improve CCD images from very light polluted sights.

#### 2.4.2. Double Correlated Sampling Readout

During readout, the charge stored in a pixel is stored temporarily on a capacitor. This capacitor converts the optically generated charge to a voltage level for the output amplifier to sense. When the readout process for the previous pixel is completed, the capacitor is drained and the next charge shifted, read, and so on. However, each time the capacitor is drained, some residual charge remains.

This residual charge is actually the dominant noise source in CCD readout electronics. This residual charge may be measured before the next charge is shifted in, and the actual difference calculated. This is called double correlated sampling. It produces more accurate data at the expense of slightly longer read out times (two measurements are made instead of one). The Research Series cameras utilize double correlated sampling to produce the lowest

## Section 2 - Introduction to CCD Cameras

possible readout noise. At  $10e^-$  to  $15e^-$  rms per read these cameras are unsurpassed in performance.

### 2.4.3. Dark Frames

No matter how much care is taken to reduce all sources of unwanted noise, some will remain. Fortunately, however, due to the nature of electronic imaging and the use of computers for storing and manipulating data, this remaining noise can be drastically reduced by the subtraction of a dark frame from the raw light image. A dark frame is simply an image taken at the same temperature and for the same duration as the light frame with the source of light to the CCD blocked so that you get a "picture" of the dark. This dark frame will contain an image of the noise caused by dark current (thermal noise) and other fixed pattern noise such as read out noise. When the dark frame is subtracted from the light frame, this pattern noise is removed from the resulting image. The improvement is dramatic for exposures of more than a minute, eliminating the many "hot" pixels one often sees across the image, which are simply pixels with higher dark current than average.

### 2.4.4. Flat Field Images

Another way to compensate for certain unwanted optical effects is to take a "flat field image" and use it to correct for variations in pixel response uniformity across the area of your dark-subtracted image. You take a flat field image of a spatially uniform source and use the measured variations in the flat field image to correct for the same unwanted variations in your images. The Flat Field command allows you to correct for the effects of vignetting and nonuniform pixel responsivity across the CCD array.

The Flat Field command is very useful for removing the effects of vignetting that may occur when using a field compression lens and the fixed pattern responsivity variations present in all CCDs. It is often difficult to visually tell the difference between a corrected and uncorrected image if there is little vignetting, so you must decide whether to take the time to correct any or all of your dark-subtracted images. It is always recommended for images that are intended for accurate photometric measurements.

Appendix D describes how to take a good flat field. It's not that easy, but we have found a technique that works well for us.

### 2.4.5. Pixels vs. Film Grains

Resolution of detail is determined, to a certain degree, by the size of the pixel in the detector used to gather the image, much like the grain size in film. The size of the pixels found in the Research cameras ranges from 7.4 to 24 microns square. One must match the size of the pixel in a particular camera to the appropriate focal length to achieve the maximum resolution allowed by the user's seeing conditions. The effects of seeing are usually the limiting factor in any good photograph or electronic image. On a perfect night with excellent optics an observer might hope to achieve sub-arcsecond seeing in short exposures, where wind vibration and tracking error are minimal or 2-3 arcsecond seeing on long exposures. With the average night sky and good optics, you will be doing well to achieve stellar images in a long exposure of 3 to 6 arcseconds halfwidth. This will still result in an attractive image, though.



## Section 2 - Introduction to CCD Cameras

Using an STL-11000M or STL-6303E camera with their 9 micron pixels, a telescope of ~75 inches focal length will produce a single pixel angular subtense of 1 arcsecond. A 0.5X focal reducer would shorten the effective focal length to 36 inches and produce images of 2 arcseconds per pixel. If seeing affects the image by limiting resolution to 6 arcseconds, you would be hard pressed to see any resolution difference between the two focal lengths as you are mostly limited by the sky conditions. However, the system with 36 inches focal length would have a larger field of view and more faint detail due to the faster optic. The STL-1001E, with its 24 micron pixels would have the same relationship at roughly 195 inches focal length. See table 2.2 for further information.

A related effect is that, at the same focal length, larger pixels collect more light from nebular regions than small ones, reducing the noise at the expense of resolution. While many people think that smaller pixels are a plus, you pay the price in sensitivity due to the fact that smaller pixels capture less light. For example, the STL-1001E with its large 24 x 24 micron pixels captures seven times as much light as the STL-6303E and STL-11000M's 9 micron square pixels. For this reason we provide 2x2 or 3x3 binning of pixels on most SBIG cameras. With the STL-11000M and STL-6303E, for instance, the cameras may be configured for 18 or 27-micron square pixels. Binning is selected using the Camera Setup Command. It is referred to as resolution (High =  $9\mu^2$  pixels, Medium =  $18\mu^2$  pixels, Low =  $27\mu^2$  pixels). When binning is selected the electronic charge from groups of 2x2 or 3x3 pixels is electronically summed in the CCD before readout. This process adds no noise and may be particularly useful on the STL-4020M with its very small 7.4 micron pixels. Binning should be used if you find that your stellar images have a halfwidth of more than several (3 - 4) pixels. If you do not bin, you are wasting sensitivity without benefit. Binning also shortens the download time.

The halfwidth of a stellar image can be determined using the crosshairs mode. Find the peak value of a relatively bright star image and then find the pixels on either side of the peak where the value drops to 50% of the peak value (taking the background into account, if the star is not too bright). The difference between these pixel values gives the stellar halfwidth. Sometimes you need to interpolate if the halfwidth is not a discrete number of pixels.

Another important consideration is the field of view of the camera. For comparison, the diagonal measurement of a frame of 35mm film is approximately 43mm. The relative CCD sizes for all of the Research Series cameras and their corresponding fields of view through a telescope with a focal length of 100 inches are given below. The field of view is inversely proportional to focal length. So, for example, cutting the focal length to 50 inches will result in a field of view that is twice the value shown below:

Camera	Array Dimensions	Diagonal	Field of View at 100" FL
TC-237 Tracking CCD	4.93 x 3.71 mm	6.17 mm	8.2 x 6.2 arcminutes
STL-4020M	15.2 x 15.2 mm	21.4 mm	29 arcminutes
STL-1302E	20.5 x 16.4 mm	26.2 mm	35.5 arcminutes
STL-1001E	24.6 x 24.6 mm	34.8 mm	47.1 arcminutes
STL-6303E	27.6 x 18.4 mm	33.2 mm	44.9 arcminutes
STL-11000M	36.1 x 24.7mm	43.7 mm	59.1 arcminutes
35mm Film	36 x 24 mm	43 mm	59 arcminutes

*Table 2.2 - CCD Array Dimensions*

## Section 2 - Introduction to CCD Cameras

### 2.4.6. Guiding

Any time you are taking exposures longer than several seconds, whether you are using a film camera or a CCD camera, the telescope needs to be guided to prevent streaking. While modern telescope drives are excellent with PEC or PPEC, they will not produce streak-free images without adjustment every 30 to 60 seconds. The Research Series cameras allow simultaneous guiding and imaging, called self-guiding (US Patent 5,525,793). This is possible because of the unique design employing 2 CCDs. One CCD guides the telescope while the other takes the image. This resolves the conflicting requirements of short exposures for guiding accuracy and long exposures for dim objects to be met, something that is impossible with single CCD cameras. Up to now the user either had to set up a separate guider or use Track and Accumulate to co-add several shorter images. The dual CCD design allows the guiding CCD access to the large aperture of the main telescope without the inconvenience of off-axis radial guiders. Not only are guide stars easily found, but the problems of differential deflection between guide scope and main scope eliminated.

Track and Accumulate is another SBIG patented process (US #5,365,269) whereby short exposures are taken and added together with appropriate image shifts to align the images. It is supported by the camera software, but will generally not produce as good as results as self guiding, where the corrections are more frequent and the accumulated readout noise less. It is handy when no connection to the telescope drive is possible and also works best on cameras with larger pixels like the STL-1001E or STL-1301E or for cameras with smaller pixels in binned mode. For cameras with smaller pixels imaging in high resolution mode, SBIG is proud to make self-guiding available to the amateur, making those long exposures required by the small pixel geometry easy to achieve!

### 2.5. Electronic Imaging

Electronic images resemble photographic images in many ways. Photographic images are made up of many small particles or grains of photo sensitive compounds which change color or become a darker shade of gray when exposed to light. Electronic images are made up of many small pixels which are displayed on your computer screen to form an image. Each pixel is displayed as a shade of gray, or in some cases a color, corresponding to a number which is produced by the electronics and photo sensitive nature of the CCD camera. However, electronic images differ from photographic images in several important aspects. In their most basic form, electronic images are simply groups of numbers arranged in a computer file in a particular format. This makes electronic images particularly well suited for handling and manipulation in the same fashion as any other computer file.

An important aspect of electronic imaging is that the results are available immediately. Once the data from the camera is received by the computer, the resulting image may be displayed on the screen at once. While Polaroid cameras also produce immediate results, serious astrophotography ordinarily requires hypersensitized or cooled film, a good quality camera, and good darkroom work to produce satisfying results. The time lag between exposure of the film and production of the print is usually measured in days. With electronic imaging, the time between exposure of the chip and production of the image is usually measured in seconds.

Another very important aspect of electronic imaging is that the resulting data are uniquely suited to manipulation by a computer to bring out specific details of interest to the

## Section 2 - Introduction to CCD Cameras

observer. In addition to the software provided with the camera, there are a number of commercial programs available which will process and enhance electronic images. Images may be made to look sharper, smoother, darker, lighter, etc. Brightness, contrast, size, and many other aspects of the image may be adjusted in real time while viewing the results on the computer screen. Two images may be inverted and electronically "blinked" to compare for differences, such as a new supernova, or a collection of images can be made into a large mosaic. Advanced techniques such as maximum entropy processing will bring out otherwise hidden detail.

Of course, once the image is stored on a computer disk, it may be transferred to another computer just like any other data file. You can copy it or send it via modem to a friend, upload it to your favorite bulletin board or online service, or store it away for processing and analysis at some later date.

We have found that an easy way to obtain a hard copy of your electronic image is to photograph it directly from the computer screen. You may also send your image on a floppy disk to a photo lab which has digital photo processing equipment for a professional print of your file. Make sure the lab can handle the file format you will send them. Printing the image on a printer connected to your computer is also possible depending on your software/printer configuration. There are a number of software programs available, which will print from your screen. However, we have found that without specialized and expensive equipment, printing images on a dot matrix or laser printer yields less than satisfactory detail. However, if the purpose is simply to make a record or catalog the image file for easy identification, a dot matrix or laser printer should be fine. Inkjet printers are getting very good, though.

### 2.6. Black and White vs. Color

The first and most obvious appearance of most scientific CCD image is that they are produced in shades of gray, rather than color. The CCD chip used in SBIG cameras itself does not discriminate color and the pixel values that the electronics read out to a digital file are only numbers proportional to the number of electrons produced when photons of any wavelength happen to strike its sensitive layers.

Of course, there are color video cameras, and a number of novel techniques have been developed to make the CCD chip "see" color. The most common way implemented on commercial cameras is to partition the pixels into groups of three, one pixel in each triplet "seeing" only red, green or blue light. The results can be displayed in color. The overall image will suffer a reduction in resolution on account of the process. A newer and more complicated approach in video cameras has been to place three CCD chips in the camera and split the incoming light into three beams. The images from each of the three chips, in red, green and blue light is combined to form a color image. Resolution is maintained. For normal video modes, where there is usually plenty of light and individual exposures are measured in small fractions of a second, these techniques work quite well. However, for astronomical work, exposures are usually measured in seconds or minutes. Light is usually scarce. Sensitivity and resolution are at a premium. The most efficient way of imaging under these conditions is to utilize all of the pixels, collecting as many photons of any wavelength, as much of the time as possible.

In order to produce the best color images in astronomy, the most common technique is to take three images of the same object using a special set of filters and then recombine the

## Section 2 - Introduction to CCD Cameras

images electronically to produce a color composite or RGB color image. The Research model cameras contain internal motorized color filter wheel. When filters are installed in the filter wheel, light entering the camera passes through the colored filter before it strikes the CCD. An object is then exposed using a red filter. The wheel is commanded to insert the green filter in place, and another image taken. Finally a blue image is taken. When all three images have been saved, they may be merged into a single color image using SBIG or third party color software.

## Section 3 - At the Telescope with a CCD Camera

### 3. At the Telescope with a CCD Camera

This section describes what goes on the first time you take your CCD camera out to the telescope. You should read this section throughout before working at the telescope. It will help familiarize you with the overall procedure that is followed without drowning you in the details. It is recommended you first try operating the camera in comfortable, well lit surroundings to learn its operation.

#### 3.1. Step by Step with a CCD Camera

In the following sections we will go through the steps of setting up and using your CCD camera. The first step is attaching the camera to the telescope. The next step is powering up the camera and establishing a communication link to your computer. Then you will want to focus the system, find an object and take an image. Once you have your light image with a dark frame subtracted, you can display the image and process the results to your liking. Each of these steps is discussed in more detail below.

#### 3.2. Attaching the Camera to the Telescope

All of the large format Research Series cameras are similar in configuration. The CCD head attaches to the telescope by slipping the camera's 2" nosepiece into a good quality 2" eyepiece holder. You may wish to add one or more extra set-screws to your eyepiece holder for a more secure attachment. Also, third party eyepiece holders are available with two or three set-screws and clamp rings that will hold the cameras securely. A fifteen-foot cable runs from the head to the host computer's USB port. The camera is powered by a desktop power supply. Operation from a car battery is also possible.

Connect the CCD head to the USB port of your computer using the supplied cable and insert the CCD Camera's nosepiece into your telescope's eyepiece holder. Fully seat the camera against the end of the draw tube so that once focus has been achieved you can swap out and replace the camera without having to refocus.

Next, connect the power cable and plug in the desktop power supply. A few seconds after you establish a link using CCDOPS software, the red LED on the rear of the camera should glow and the fan should spin indicating that the firmware has been uploaded to the camera and it is ready for operation. We recommend draping the cables over the finder scope, saddle or mount to minimize cable perturbations of the telescope, and guard against the camera falling out of the drawtube to the floor. In the alternative, there is a 1/4-20 threaded hole on the side plate of the camera used for tripod mounting. This is also a convenient place to attach a safety strap to prevent the camera from accidentally falling from the telescope. If you have installed the handles on the rear of the camera, you can also pass a safety line through one of the handles as a precaution.

#### 3.3. Establishing a Communications Link

After setting up the software and the camera as described in the previous sections, using CCDOPS software, establish a link to the camera by clicking on the "Establish Comm Link" command from the Camera menu. If the software is successful the "Link" field in the Status Window is updated to show the type of camera found. If the camera is not connected, powered

### Section 3 - At the Telescope with a CCD Camera

up, or the USB port has not yet been properly selected, a message will be displayed indicating that the software failed to establish a link to the camera. If this happens, use the Communications Setup command in the Misc menu to configure the CCDOPS software for the USB. Then use the Establish COM Link command in the Camera Menu to establish communications with the camera.

Note: *It is not necessary to have a camera connected to your computer to run the software and display images already saved onto disk. It is only necessary to have a camera connected when you take new images.*

Once the COM link has been established you may need to set the camera's setpoint temperature in the Camera Setup command. The Research Series cameras power up regulating to whatever temperature the CCD is at, which in this case will be the ambient temperature. Use the Camera Setup command and choose a setpoint temperature approximately 30°C below the ambient temperature. Type in the setpoint, set the temperature control to active, and hit ENTER. Another way to set the camera for the lowest temperature for a given night is to choose a set point lower than the camera can cool (i.e., -50 degrees C) and read the actual temperature it is able to achieve then adjust the setpoint to a few degrees above this minimum temperature. This will work well if the ambient temperature does not rise during the night. If you notice that the cooler must work at 100% power to attempt to maintain the setpoint, then you should raise the setpoint approximately 3 degrees higher than the temperature the camera is actually able to maintain.

#### 3.4. Focusing the CCD Camera

Before using the software to focus the camera the first time you should place a diffuser (such as scotch tape or ground glass) at the approximate location of the CCD's sensitive surface behind the 2" eyepiece holder and focus the telescope on the moon, a bright planet or a distant street lamp. This preliminary step will save you much time in initially finding focus. The approximate distance behind the 2" eyepiece tube for the Research Cameras is described in the drawing at right.

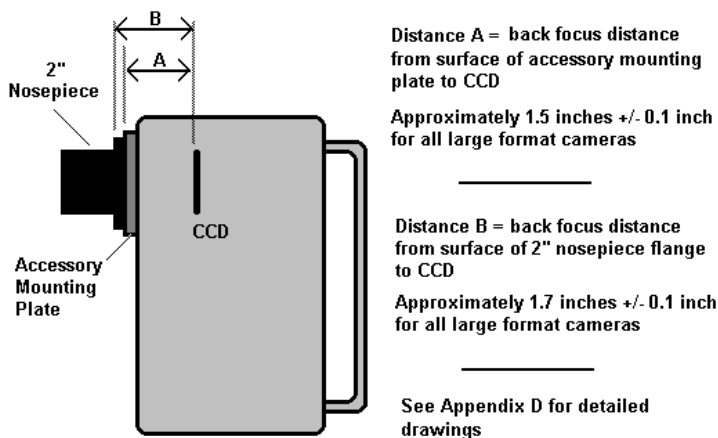

Distance A = back focus distance from surface of accessory mounting plate to CCD

Approximately 1.5 inches +/- 0.1 inch for all large format cameras

Distance B = back focus distance from surface of 2" nosepiece flange to CCD

Approximately 1.7 inches +/- 0.1 inch for all large format cameras

See Appendix D for detailed drawings

To achieve fine focus, insert the CCD head into the eyepiece tube, taking care to seat it, and then enter the CCDOPS FOCUS mode. The Focus command automatically displays successive images on the screen as well as the peak brightness value

of the brightest object in the field of view. Point the telescope at a bright star. Center the star image in the CCD, and adjust the focus until the star image is as small as can be discerned. Next, move the telescope to a field of fainter stars that are dimmer so the CCD is not saturated. Further adjust the focus to maximize the displayed star brightness in counts and minimize the

## Section 3 - At the Telescope with a CCD Camera

star diameter. This can be tedious. It helps considerably if a pointer or marker is affixed to the focus knob so you can rapidly return to the best focus once you've gone through it.

For critical focus, an exposure of about 1 second is recommended to smooth out some of the atmospheric effects. While you can use the Full frame mode to focus, the frame rate or screen update rate can be increased significantly by using Planet mode. In Planet mode the Focus command takes a full image and then lets you position a variable sized rectangle around the star. On subsequent images the Planet mode only digitizes, downloads, and displays the small area you selected. The increase in frame rate is roughly proportional to the decrease in frame size, assuming you are using a short exposure.

The telescope focus is best achieved by maximizing the peak value of the star image. You should be careful to move to a dimmer star if the peak brightness causes saturation. In order to avoid saturation, move to a dimmer star if the peak brightness counts are 40,000 or more. Another point you should also be aware of is that as you approach a good focus, the peak reading can vary by 30% or so. This is due to the fact that as the star image gets small, where an appreciable percentage of the light is confined to a single pixel, shifting the image a half a pixel reduces the peak brightness as the star's image is split between the two pixels. The Kodak CCD pixels are so small that this is not likely to be a problem.

Once the best focus is found, the focusing operation can be greatly shortened the second time by removing the CCD head, being careful not to touch the focus knob. Insert a high power eyepiece and slide it back and forth to find the best visual focus, and then scribe the outside of the eyepiece barrel. The next time the CCD is used the eyepiece should be first inserted into the tube to the scribe mark, and the telescope visually focused and centered on the object. At  $f/6$  the depth of focus is only 0.005 inch, so focus is critical. An adapter may be necessary to allow the eyepiece to be held at the proper focus position. SBIG sells extenders for this purpose.

### 3.5. Finding and Centering the Object

Once best focus is achieved, we suggest using "Dim" mode to help center objects. This mode gives a full field of view, but reduces resolution in order to increase the sensitivity, and digitization and download rate. If you have difficulty finding an object after obtaining good focus, check to be sure that the head is seated at best focus, then remove the head and insert a medium or low power eyepiece. Being careful not to adjust the focus knob on the telescope, slide the eyepiece in or out until the image appears in good focus. Then visually find and center the object, if it is visible to the eye. If not, use your setting circles carefully. Then, re-insert the CCD head and use FOCUS mode with an exposure time of about ten seconds, if it is dim. Center the object using the telescope hand controls.

Note: *With a 10 second exposure, objects like M51 or the ring nebula are easily detected with modest amateur telescopes. The cores of most galactic NGC objects can also be seen.*

### 3.6. Taking an Image

Take a CCD image of the object by selecting the Grab command and setting the exposure time. Start out with the Image size set to full and Auto Display and Auto contrast enabled. The camera will expose the CCD for the correct time, and digitize and download the image. One can also take a dark frame immediately before the light image using the Grab command.

## Section 3 - At the Telescope with a CCD Camera

Because the Research Series cameras have regulated temperature control, you may prefer to take and save separate dark images, building up a library at different temperatures and exposure times, and reusing them on successive nights. At the start it's probably easiest to just take the dark frames when you are taking the image. Later, as you get a feel for the types of exposures and setpoint temperatures you use, you may wish to build this library of dark frames.

### 3.7. Displaying the Image

The image can be displayed on the computer screen using the graphics capability of your PC. Auto contrast can be selected and the software will pick background and range values which are usually good for a broad range of images or the background and range values can be optimized manually to bring out the features of interest.

The image can also be displayed as a negative image, or can be displayed with smoothing to reduce the graininess. Once displayed, the image can be analyzed using crosshairs, or can be cropped or zoomed to suit your tastes.

### 3.8. Processing the Image

If not done already, images can be improved by subtracting off a dark frame of equal exposure. You will typically do this as part of the Grab command although it can also be done manually using the Dark Subtract command. By subtracting the dark frame, pixels which have higher dark current than the average, i.e., "hot" pixels, are greatly suppressed and the displayed image appears much smoother. Visibility of faint detail is greatly improved.

The CCDOPS program also supports the use of flat field frames to correct for vignetting and pixel to pixel variations, as well as a host of other image processing commands in the Utility menu. You can smooth or sharpen the image, flip it to match the orientation of published images for comparison, or remove hot or cold pixels.

### 3.9. Advanced Capabilities

The following sections describe some of the advanced features of SBIG cameras. While you may not use these features the first night, they are available and a brief description of them is in order for your future reference.

#### 3.9.1. Crosshairs Mode (Photometry and Astrometry)

Using the crosshair mode enables examination of images on a pixel by pixel basis for such measurements as Stellar and Diffuse Magnitude, and measurement of stellar positions. The 16 bit accuracy of SBIG systems produces beautiful low-noise images and allows very accurate brightness measurements to be made. With appropriate filters stellar temperature can be measured.

In the crosshair mode, you move a small cross shaped crosshair around in the image using the keyboard or the mouse. As you position the crosshair, the software displays the pixel value beneath the crosshair and the X and Y coordinates of the crosshair. Also shown is the average pixel value for a box of pixels centered on the crosshair. You can change the size of the averaging box from 3x3 to 31x31 pixels to collect all the energy from a star.



## Section 3 - At the Telescope with a CCD Camera

### 3.9.2. Sub-Frame Readout in Focus

The Focus command offers several frame modes for flexibility and increased frame throughput. As previously discussed, the Full frame mode shows the entire field of view of the CCD with the highest resolution, digitizing and displaying all pixels.

The "Dim" mode offers the same field of view but offers higher frame rates by reducing the image's resolution prior to downloading. The resolution is reduced by combining a neighboring block of pixels into a "super pixel". This reduces the download and display times proportionately, as well as improving sensitivity. It is great for finding and centering objects.

The Planet mode is suggested if high spatial resolution is desired for small objects like planets. The Planet mode allows you to select a small sub-area of the entire CCD for image acquisition. The highest resolution is maintained but you don't have to waste time digitizing and processing pixels that you don't need. Again, the image throughput increase is proportional to the reduction in frame size. It can be entered from Auto mode.

Another aspect of the Focus command and its various modes is the Camera Resolution<sup>2</sup> setting in the Camera Setup command. Briefly, the Resolution setting allows trading off image resolution (pixel size) and image capture time while field of view is preserved. High resolution with smaller pixels takes longer to digitize and download than Low resolution with larger pixels. The cameras support High, Medium, Low and Auto resolution modes. The Auto mode is optimized for the Focus command. It automatically switches between Low resolution for Full frame mode to provide fast image acquisition, and High resolution for Planet mode to achieve critical focus. While Auto resolution is selected all images acquired using the GRAB command will be high resolution.

### 3.9.3. Track and Accumulate

An automatic Track and Accumulate mode (SBIG patented) is available in CCDOPS which simplifies image acquisition for the typical amateur with an accurate modern drive. These drives, employing PEC or PPEC technology and accurate gears, only need adjustment every 30 to 120 seconds. With Track and Accumulate the software takes multiple exposures and automatically co-registers and co-adds them. The individual exposures are short enough such that drive errors are not objectionable and the accumulated image has enough integrated exposure to yield a good signal to noise ratio.

Operationally the camera will take an exposure, determine the position of a preselected star, co-register and co-add the image to the previous image, and then start the cycle over again. The software even allows making telescope corrections between images to keep the object positioned in the field of view. The resulting exposure is almost as good as a single long exposure, depending on the exposure used and sky conditions. The great sensitivity of the CCD virtually guarantees that there will be a usable guide star within the imaging CCD's field of view. This feature provides dramatic performance for the amateur, enabling long exposures with minimal setup!

---

<sup>2</sup> The Resolution setting in the Camera Setup command combines pixels before they are digitized. This is referred to as on-chip binning and offers increases in frame digitization rates.

## Section 3 - At the Telescope with a CCD Camera

### 3.9.4. Autoguiding and Self Guiding

The CCDOPS software allows the Research Series cameras to be used as autoguiders and self-guiders through the commands in the Track menu. While these systems are not stand-alone like the old ST-4, but require a host computer, they can accurately guide long duration astrophotographs and CCD images with equal or superior accuracy. Their sensitivity is much greater than an ST-4, and the computer display makes them easier to use.

When functioning as an autoguiding, the CCD camera repeatedly takes images of a guide star, measures the star's position to a fraction of a pixel accuracy, and corrects the telescope's position through the hand controller. While autoguiding alleviates the user of the tedious task of staring through an eyepiece for hours at a time, it is by no means a cure to telescope drive performance. All the things that were important for good manually guided exposures still exist, including a good polar alignment, rigid tubes that are free of flexure and a fairly good stable mount and drive corrector. Remember that the function of an auto guider is to correct for the small drive errors and long term drift, not to slew the telescope.

One of the reasons that SBIG autoguiders are often better than human guiders is that, rather than just stabbing the hand controller to bump the guide star back to the reticule, it gives a precise correction that is the duration necessary to move the guide star right back to its intended position. It knows how much correction is necessary for a given guiding error through the Calibrate Track command. The Calibrate Track command, which is used prior to autoguiding, exercises the telescope's drive corrector in each of the four directions, measuring the displacement of a calibration star after each move. Knowing the displacement and the duration of each calibration move calibrates the drive's correction speed. Once that is known, the CCD tracker gives the drive corrector precise inputs to correct for any guiding error.

When self-guiding is selected by invoking the Self Guiding command under the Track Menu, the computer prompts the user for the exposure time for the tracking and imaging CCDs. Once these are entered, the computer takes and displays an image with the tracking CCD, and the user selects a guide star using the mouse. Guide stars that are bright, but not saturating, and isolated from other stars are preferred. Once the star is selected, the computer starts guiding the telescope. When the telescope corrections settle down (usually once the backlash is all taken up in the declination drive) the user starts the exposure by striking the space bar. The computer then integrates for the prescribed time while guiding the telescope, and downloads the image for display.

A calibration star should be chosen that is relatively bright and isolated. The calibration software can get confused if another star of comparable brightness moves onto the tracking CCD during a move. The unit will self-guide on much fainter stars. Tests at SBIG indicate that the probability of finding a usable guide star on the tracking CCD is about 95% at F/6.3, in regions of the sky away from the Milky Way. If a guide star is not found the telescope position should be adjusted, or the camera head rotated by a multiple of 90 degrees to find a guide star. We recommend that the user first try rotating the camera 180 degrees. Rotating the camera will require recalibration of the tracking function. [Note: CCDSoftV5 software allows SBIG cameras to calibrate and track in any orientation, similar to the STV video autoguiding].

## Section 3 - At the Telescope with a CCD Camera

### 3.9.5. Auto Grab

The Auto Grab command allows you to take a series of images at a periodic interval and log the images to disk. This can be invaluable for monitoring purposes such as asteroid searches or stellar magnitude measurements. You can even take sub-frame images to save disk space if you don't need the full field of view.

### 3.9.6. Color Imaging

Since all SBIG cameras are equipped with monochromatic CCDs, discriminating only light intensity, not color, some provision must be made in order to acquire color images. The Research Series cameras have an internal filter carousel that will accept filters for color imaging. The color filter wheel allows placing of interference filters in front of the CCD in order to take multiple images in different color bands. These narrow band images are then combined to form a color image. With the SBIG system, a Red, Green and Blue filter are used to acquire three images of the object. The resulting images are combined to form a tri-color image using CCDOPS, CCDSoftV5 or third party software.

Color imaging places some interesting requirements on the user that bear mentioning. First, many color filters have strong leaks in the infrared (IR) region of the spectrum, a region where CCDs have relatively good response. If the IR light is not filtered out then combining the three images into a color image can give erroneous results. If your Blue filter has a strong IR leak (quite common) then your color images will look Blue. For this reason, SBIG incorporates an IR blocking filter stack with the three color band filters.

Second, since you have narrowed the CCD's wavelength response with the interference filters, longer exposures are required to achieve a similar signal to noise compared to what one would get in a monochrome image with wide spectral response. This is added to the fact that tri-color images require a higher signal to noise overall to produce pleasing images. With black and white images your eye is capable of pulling large area detail out of random noise quite well, whereas with color images your eye seems to get distracted by the color variations in the noisy areas of the image. The moral of the story is that while you can achieve stunning results with CCD color images, it is quite a bit more work.



## Section 4 – Camera Hardware

### 4. Camera Hardware

This section describes the modular components that make up the CCD Camera System and how they fit into the observatory, with all their connections to power and other equipment.

#### 4.1. System Components

The Research Series CCD cameras consist of four major components: the CCD Sensors and Preamplifier, the Readout/Clocking Electronics, the Microcontroller, and the power supply. All the electronics are packaged in the optical head in these cameras with an external desktop power supply.

The CCDs, Preamplifier, and Readout Electronics are mounted in the front of the optical head. The optical head interfaces to the telescope through a 2 inch (or larger) draw tube, sliding into the telescope's focus mechanism. The placement of the preamplifier and readout electronics close to the CCD is necessary to achieve good noise performance. The Microcontroller is housed in the rear of the Optical Head along with the interface logic to the PC and Telescope.

#### 4.2. Connecting the Power

The desktop power supply is designed to run off voltages found in most countries (90 to 240 VAC). In the field however, battery operation may be the most logical choice. In that case you need to use the optional 12V power supply or a 12VDC to 110 VAC power inverter.

#### 4.3. Connecting to the Computer

The Research Series CCD cameras are supplied with a 15 foot cable to connect the system to the host computer. The connection is between the camera and the Host Computer's USB port. If it is necessary or desirable to extend the distance between the camera and the computer, third party USB extenders such as the "Ranger" made by Icron (<http://www.icron.com>) may be used for remote operation up to 100 meters.

#### 4.4. Connecting the Relay Port to the Telescope

The Research Series camera systems can be used as autoguiders where the telescope's position is periodically corrected for minor variations in the RA and DEC drives. The host software functions as an autoguider in three modes: the Track mode, the SBIG patented Track and Accumulate mode, and the SBIG patented Self-Guided mode (except for the ST-1001E).

In the Track mode and Self Guided mode the host software corrects the telescope as often as once every second to compensate for drift in the mount and drive system. The host software and the CCD camera operate in tandem to repeatedly take exposures of the designated guide star, calculate its position to a tenth of a pixel accuracy, and then automatically activate the telescope's controller to move the star right back to its intended position. It does this tirelessly to guide long duration astrophotographs.

In the Track and Accumulate mode the software takes a series of images and automatically co-registers and co-adds the images to remove the effects of telescope drift. Typically you would take ten 1 minute "snapshots" to produce an image that is comparable to a

## Section 4 - Camera Hardware

single 10 minute exposure except that no guiding is required. The reason no guiding is required is that with most modern telescope mounts the drift over the relatively short 1 minute interval is small enough to preserve round star images, a feat that even the best telescope mounts will not maintain over the longer ten minute interval. The Track and Accumulate software does allow correction of the telescope position in the interval between snapshots to keep the guide star grossly positioned within the field of view, but it is the precise co-registration of images that accounts for the streakless images.

The host software and the CCD camera control the telescope through the 9-pin Telescope port on the camera. This port provides active low open collector signals to the outside world. By interfacing the camera to the telescope's controller the CPU is able to move the telescope as you would: by effectively closing one of the four switches that slews the telescope.

*Note: You only need to interface the camera's Telescope port to your telescope if you are planning on using the camera system as an autoguider or selfguider, or feel you need to have the Track and Accumulate command make telescope corrections between images because your drive has a large amount of long term drift.*

Some recent model telescopes have connectors on the drive controller that interface directly to the camera's TTL level Telescope port. All that's required is a simple cable to attach the 9 pin Telescope port to the telescope's telephone jack type CCD connector. SBIG includes its STL-RC adapter and cable for this express purpose although it is easy to modify a standard 6-pin telephone cable for interface to the Telescope port (see Appendix A for specific pin outs, etc.). The STL-RC plugs into the 9-pin port on the camera, and a standard phone cable, which we supply, connects the adapter to the telescope drive. Note: phone cables come in a few variations. We use the six-pin cable, and the pin order is reversed left to right relative to the connector from one end to the other. This is identical to what is typically sold at Radio Shack stores as an extension cable.

### 4.4.1 Using Mechanical Relays

Older telescopes generally require modifying the hand controller to accept input from the camera's Telescope port. The difficulty of this task varies with the drive corrector model and may require adding external relays if your drive corrector will not accept TTL level signals. We sell a mechanical relay box that interfaces to the Research Series cameras, and will interface to the older drives. Contact SBIG for more information.

In general, the camera has four signals that are used in tracking applications. There is one output line for each of the four correction directions on the hand controller (North, South, East and West). Our previous cameras had internal relays for the telescope interface, but with the proliferation of TTL input telescopes the relays were removed (We do offer an external relay adapter accessory). The following paragraphs describe the general-purpose interface to the telescope which involves using external relays.

In our older camera models and in the optional relay adapter accessory, each of the relays has a Common, a Normally Open, and a Normally Closed contact. For example, when the relay is inactivated there is a connection between the Common and the Normally Closed contact. When the relay is activated (trying to correct the telescope) the contact is between the Common and the Normally Open contacts.

## Section 4 - Camera Hardware

If your hand controller is from a relatively recent model telescope it probably has four buttons that have a "push to make" configuration. By "push to make" we mean that the switches have two contacts that are shorted together when the button is pressed. If that's the case then it is a simple matter of soldering the Common and Normally Open leads of the appropriate relay to the corresponding switch, without having to cut any traces, as shown in Figure 4.1 below.

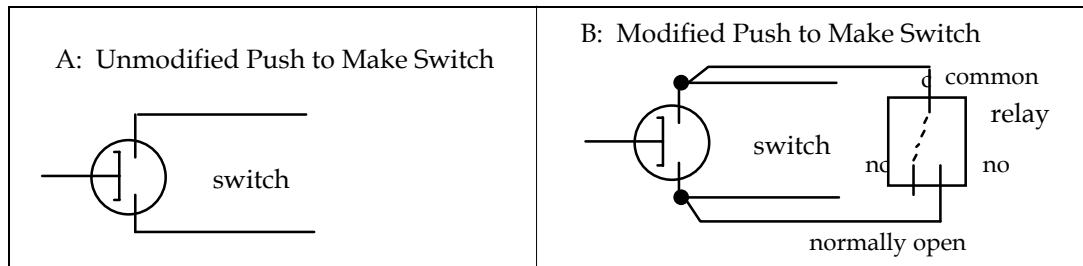

*Figure 4.1 - Push to Make Switch Modification*

Another less common type of switch configuration (although it seems to have been used more often in older hand controllers) involve hand controller buttons that use both a push to make contact in conjunction with a push to break contact. The modification required for these switches involves cutting traces or wires in the hand controller. Essentially the relay's Normally Open is wired in parallel with the switch (activating the relay or pushing the hand controller button closes the Normally Open or Push to Make contact) while at the same time the Normally Closed contact is wired in series with the switch (activating the relay or pushing the hand controller button opens the Normally Closed or the Push to Break contact). This type of switch modification is shown in Figure 4.2 below.

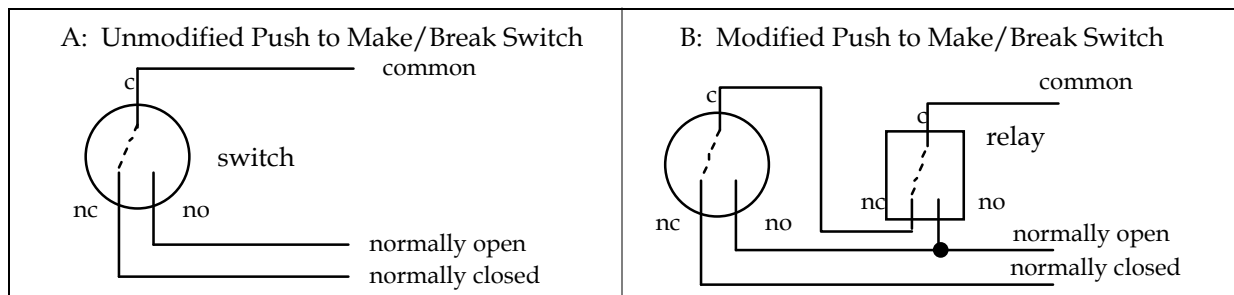

*Figure 4.2- Push to Make/Break Modification*

The last type of hand controller that is moderately common is the resistor joystick. In this joystick each axis of the joystick is connected to a potentiometer or variable resistor. Moving the joystick handle left or right rotates a potentiometer, varying the resistance between a central "wiper" contact and the two ends of a fixed resistor. The relays can be interfaced to the joystick as shown in Figure 4.3 below. Essentially the relays are used to connect the wire that used to attach to the wiper to either end of the potentiometer when the opposing relays are activated.

## Section 4 - Camera Hardware

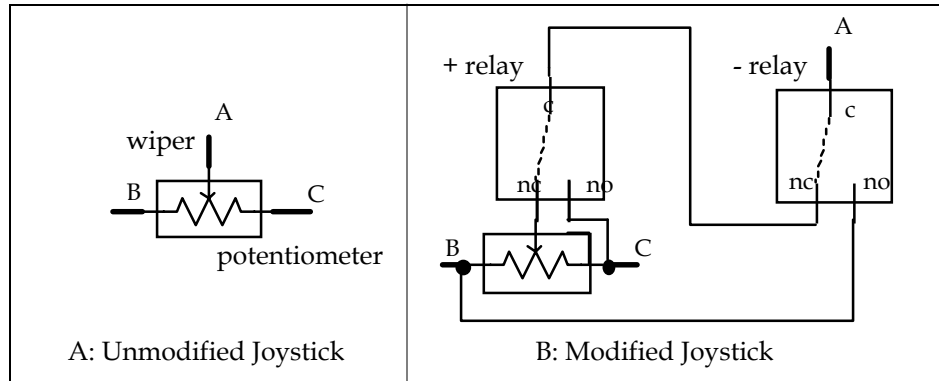

Figure 4.3 - Joystick Modification

A slight variation on the joystick modification is to build a complete joystick eliminator as shown in Figure 4.4 below. The only difference between this and the previous modification is that two fixed resistors per axis are used to simulate the potentiometer at its mid position. You do not need to make modifications to the joystick; you essentially build an unadjustable version. This may be easier than modifying your hand controller if you can trace out the wiring of your joystick to its connector.

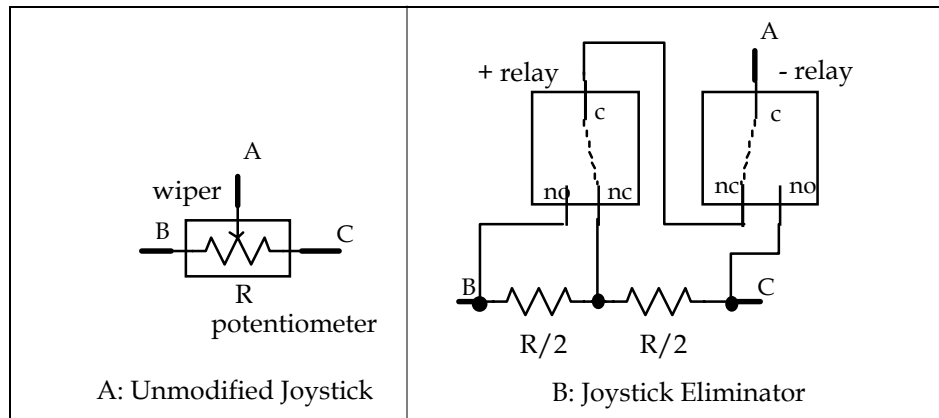

Figure 4.4- Joystick Eliminator

### 4.5. Modular Family of CCD Cameras

With the introduction of the ST-6 CCD Camera in 1992 SBIG started a line of high quality, low noise, modular CCD cameras. The ST-7E, ST-8E and ST-9E were a second family of modular CCD cameras. The ST-10E allowed for upgrades to a faster USB interface and larger tracking CCD. The Research Series of large format CCD cameras supports a variety of larger CCDs in a common electronic and mechanical design.

The benefits of a modular line of CCD Cameras are many fold. Users can buy as much CCD Camera as they need or can afford, with the assurance that they can upgrade to higher performance systems in the future. With a modular approach, camera control software like CCDOPS can easily support all models. This last point assures a wide variety of third party software. Software developers can produce one package for the many users across the model line instead of different packages for each of the cameras.



## Section 4 - Camera Hardware

How these features affect the average user are discussed in the paragraphs below:

**A/D Resolution** - This is a rough indication of the camera's dynamic range. Higher precision A/D Converters are able to more finely resolve differences in light levels, or for larger CCDs with greater full well capacities, they are able to handle larger total charges with the same resolution.

**Temperature Regulation** - In an open loop system like the original ST-4 the CCD cooling is either turned on or turned off. While this provides for adequate cooling of the CCD, the CCD's temperature is not regulated which makes it important to take dark frames in close proximity to the associated light frame. Closed loop systems regulate the CCD's temperature to an accuracy of  $\pm 0.1^\circ \text{C}$  making dark frames useful over longer periods.

**Electromechanical Shutter** - Having the shutter in the Research Series cameras gives streak-free readout and allows taking dark frames without having to cover the telescope. While the minimum exposure is 0.11 seconds, repeatability and area uniformity are excellent with SBIG's unique unidirectional shutter.

**Filter Wheel** - The internal Filter Wheel allows you to take color images or separate UBVRI for photometric measurements automatically.

**Electronic Shutter** - Having an electronic shutter involves having a CCD with a frame transfer or interline region. In frame transfer or interline CCDs at the end of the exposure, the pixel data from the Image Area is transferred into the Storage Area very rapidly where it can be read out with a minimum of streaking.

In addition to the system level differences between the various cameras, Table 4.3 below quantifies the differences between different CCDs used in the cameras:

Camera	CCD Used	Number of Pixels	Pixel Dimensions	Array Dimension	Read Noise	Full Well Capacity
TC237 Tracking CCD	TC-237	657 x 495	7.4 x 7.4 $\mu$	4.9 x 3.7 mm	15e <sup>-</sup> rms	20Ke <sup>-</sup>
STL-4020M	KAI-4020M	2048 x 2048	7.4 x 7.4 $\mu$	15.2 x 15.2 mm	15e <sup>-</sup> rms	40Ke <sup>-</sup>
STL-1301E	KAF-1301E	1280 x 1024	16 x 16 $\mu$	20.5 x 16.4 mm	15e <sup>-</sup> rms	120Ke <sup>-</sup>
STL-1001E	KAF-1001E	1024 x 1024	24 x 24 $\mu$	24.6 x 24.6 mm	15e <sup>-</sup> rms	200Ke <sup>-</sup>
STL-6303E	KAF-6303E	3072 x 2048	9 x 9 $\mu$	27.6 x 18.4 mm	15e <sup>-</sup> rms	100Ke <sup>-3</sup>
STL-11000M	KAI-11000M	4008 x 2745	9 x 9 $\mu$	36.1 x 24.7 mm	12e <sup>-</sup> rms	50Ke

*Table 4.3- CCD Differences*

How these various specifications affect the average user is described in the following paragraphs:

**Number of Pixels** - The number of pixels in the CCD affects the resolution of the final images. The highest resolution device is best but it does not come without cost. Larger CCDs cost more money and drive the system costs up. They are harder to cool, require more memory to store images, take longer to readout, etc. With typical

<sup>3</sup> Some Kodak CCDs (KAF1301E and KAF6303E) are available with or without Antiblooming Protection. Units with the Antiblooming Protection have one-half the full well capacity of the units without it.

## Section 4 - Camera Hardware

PC and Macintosh computer graphics resolutions, the CCDs used in the SBIG cameras offer a good trade off between cost and resolution, matching the computer's capabilities well.

**Pixel Dimensions** - The size of the individual pixels themselves really plays into the user's selection of the system focal length. Smaller pixels and smaller CCDs require shorter focal length telescopes to give the same field of view that larger CCDs have with longer focal length telescopes. Smaller pixels can give images with higher spatial resolution up to a point. When the pixel dimensions (in arcseconds of field of view) get smaller than roughly half the seeing, decreasing the pixel size is essentially throwing away resolution. Another aspect of small pixels is that they have smaller full well capacities.

For your reference, if you want to determine the field of view for a pixel or entire CCD sensor you can use the following formula:

$$\text{Field of view (arcseconds)} = \frac{8.12 \times \text{size } (\mu\text{m})}{\text{focal length (inches)}}$$

$$\text{Field of view (arcseconds)} = \frac{20.6 \times \text{size (um)}}{\text{focal length (cm)}}$$

where size is the pixel dimension or CCD dimension in millimeters and the focal length is the focal length of the telescope or lens. Also remember that  $1^\circ = 3600$  arcseconds.

**Read Noise** - The readout noise of a CCD camera affects the graininess of short exposure images. For example, a CCD camera with a readout noise of 30 electrons will give images of objects producing 100 photoelectrons (very dim!) with a Signal to Noise (S/N) of approximately 3 whereas a perfect camera with no readout noise would give a Signal to Noise of 10. Again, this is only important for short exposures or extremely dim objects. As the exposure is increased you rapidly get into a region where the signal to noise of the final image is due solely to the exposure interval. In the previous example increasing the exposure to 1000 photoelectrons results in a S/N of roughly 20 on the camera with 30 electrons readout noise and a S/N of 30 on the noiseless camera. It is also important to note that with the SBIG CCD cameras the noise due to the sky background will exceed the readout noise in 15 to 60 seconds on the typical amateur telescopes. Even the \$30,000 priced CCD cameras with 10 electrons of readout noise will not produce a better image after a minute of exposure!

**Full Well Capacity** - The full well capacity of the CCD is the number of electrons each pixel can hold before it starts to loose charge or bleed into adjacent pixels. Larger pixels hold more electrons. This gives an indication of the dynamic range the camera is capable of when compared to the readout noise, but for most astronomers this figure of merit is not all that important. You will rarely takes images that fill the pixels to the maximum level except for stars in the field of view. Low level nebulosity will almost always be well below saturation. While integrating longer would cause more build up of charge, the signal to noise of images like these is proportional to the square-root of the total number of electrons. To get

## Section 4 - Camera Hardware

twice the signal to noise you would have to increase the exposure 4 times. An STL-11000M with its full well capacity of  $50,000e^-$  could produce an image with a S/N in excess of 200!

Antiblooming - Some SBIG CCD cameras have antiblooming protection. The TC-237 autoguider has antiblooming built into the CCDs. The Kodak CCDs used in the STL-1301E and STL-6303E have Antiblooming versions of the CCDs available and the CCDs used in the ST-4020M and STL-11000M only come with antiblooming. Blooming is a phenomenon that occurs when pixels fill up. As charge continues to be generated in a full pixel, it has to go somewhere. In CCDs without antiblooming protection the charge spills into neighboring pixels, causing bright streaks in the image. With the CCDs used in the SBIG cameras the excess charge can be drained off saturated pixels by applying clocking to the CCD during integration. This protection allows overexposures of 100-fold without blooming. The trade off is sensitivity. Antiblooming CCDs are less sensitive than non-antiblooming CCDs. In the case of the STL-1302E and STL-6303E, for example, the non-antiblooming versions are very roughly twice as sensitive. The CCDs used in the STL1001E do not come in an antiblooming version.

## Section 4 - Camera Hardware

### 4.6. Connecting accessories to the Camera

There are two 9 pin accessory ports on the Research Series of cameras. The first is labeled "AO \SCOPE." This is the port that provides the relay output for direct connection to many popular telescopes' "CCD" autoguiding port. It also supports the relay adapter box and an adaptive optics device similar to the AO-7 which will be made for this camera in the future. supports our AO-7 Adaptive optics device, CFW8A color filter wheel and relay adapter box. (Note: This is not the same thing as the telescope's RS232 port that is commonly used to point and slew the telescope). The second accessory port on the camera is labeled I2C AUX ("I squared C") and is for future accessories. Be sure to keep the static safe cap over this port to insure that you do not accidentally plug in an accessory that is intended for the AO/SCOPE port. Plugging in the wrong accessory to the I2C port could cause damage. More than one accessory can be connected to the accessory ports by using multiple plug adapters provided with the accessory.

### 4.7. Battery Operation

The STL-4020M, STL-1301E, STL-1001E, STL-11000M and STL-6303E can be operated off of a 12 volt car or marine battery using a the optional 12V power cord. The camera draws approximately 4 amps from the battery (5 amps with the Remote Guiding Head attached) so it would not be wise to operate directly from your car battery all night without a back up battery. We recommend a separate battery for the camera; using your vehicle's battery with the engine running may add undesirable readout noise, and using your vehicle's battery without the engine running may result in a long walk home in the dark!

## Section 5 – Advanced Imaging Techniques

### 5. Advanced Imaging Techniques

With practice, you will certainly develop methods of your own to get the most from your CCD camera. In this section we offer some suggestions to save you time getting started in each of the different areas outlined below, but these suggestions are by no means exhaustive.

#### 5.1. Lunar and Planetary Imaging

When imaging the moon using most focal lengths available in astronomical telescopes, you will note that the moon's image typically fills the CCD. The image is also very bright. The best way to image the moon is to use neutral density filters to attenuate the light.

You may also try an aperture mask to reduce the incoming light. If you feel that an aperture mask reduces resolution to an unacceptable degree, consider using a full aperture solar filter. This will result in an optimum exposure of only a few seconds. Another way to reduce the incoming light is to increase the effective focal length of your telescope by using a barlow lens or eyepiece projection. This is very desirable for planetary imaging since it also increases the image size.

#### 5.2. Deep Sky Imaging

Ordinarily, with telescopes of 8" aperture or larger, a ten second exposure in focus mode, with a dark frame subtracted, will show most common deep sky objects except for the very faintest. This is a good starting point for finding and centering deep sky objects. If you find ten seconds to be insufficient, a one minute exposure will clearly show nearly any object you wish to image, particularly if 2x2 or 3x3 binning is selected. Using the Grab command, exposures of five minutes will generally give you a clear image with good detail. Of course, longer exposures are possible and desirable, depending on your telescope's tracking ability or your desire to guide. Once you have determined the longest exposure possible with your particular drive error, try Track and Accumulate exposures of a duration less than your measurable error. We have found that exposures of thirty seconds to two minutes are best depending on the focal length of telescope one is using. With the self guiding feature of the Research Series cameras, one can take long integrations while the internal tracking CCD guides the telescope.

We highly recommend that you initially pursue deep sky imaging with a fast telescope, or focal reducer to produce a final F number of F/6.3 or faster at the CCD. The sensitivity advantage is considerable!

#### 5.3. Terrestrial Imaging

An optional accessory for the Research Series cameras is the camera lens adapter (see Section 6.3). This accessory is made to accommodate popular 35mm Nikon lenses. You may attach a camera lens in place of your telescope and use the CCD camera for terrestrial views in daylight. Begin with a tenth second exposure at f/16 for scenes at normal room light and adjust as necessary for your conditions.

## Section 5 – Advanced Imaging Techniques

### 5.4. Taking a Good Flat Field

If you find that flat field corrections are necessary due to vignetting effects, CCD sensitivity variations, or for more accurate measurements of star magnitudes, try either taking an image of the twilight sky near the horizon or take an image of a blank wall or neutral grey card. The Kodak CCDs may have a low contrast grid pattern visible in the sky background. A flat field will eliminate this.

Finding areas of the sky devoid of stars is very difficult after twilight. Therefore, you should take flat field images of the night sky after sunset, but long before you can see any stars. If this is not possible, take an image of a featureless wall or card held in front of the telescope. However, if using this second method, be sure that the wall or card is evenly illuminated. Appendix C describes how to do this. You will know if the flat field is good if the sky background in your images has little variation across the frame after flat fielding, displayed using high contrast (a range of 256 counts is good for showing this).

If you plan on flat fielding Track and Accumulate images you should also refer to section 6.8. Since the same flat field is added to itself a number of times, be sure that you do not saturate the flat field image by starting with pixel values too high. Typically try to keep the pixel values between 10% to 20% of saturation for this purpose. For single flat field images, try to keep the values to approximately 50% of saturation.

### 5.5. Building a Library of Dark Frames

The Research Series cameras have regulated temperature control, and therefore it is possible to duplicate temperature and exposure conditions on successive nights. You can set the camera TE cooler temperature to a value comfortably within reach on your average night, and then take and save on disk a library of dark frames for later use. This is a good project for a rainy night. We recommend you build a file of 5, 10, 20, 40, and 60 minute dark frames at zero degrees Centigrade for a start. Otherwise you will find yourself wasting a clear night taking hour-long dark frames!

**Note:** *Dark frames taken the same night always seem to work better. The adaptive dark subtract will help if the ambient temperature changes slightly.*

### 5.6. Changing the Camera Resolution

The Camera Setup command allows you to select the resolution mode you wish to use for taking and displaying images. The Research Series have High, Medium, Low and Auto modes. The High Resolution mode is the best for displaying the greatest detail since it utilizes the maximum number of pixels for your particular camera. The Medium Resolution Mode operates by combining 2x2 pixels giving the same field of view as High Resolution Mode, but with 1/4 the resolution. This results in significantly faster digitization and download times. Also, in Medium Resolution Mode, with larger pixels and comparable readout noise there is a better signal to noise ratio for very dim diffuse objects. This improved signal to noise ratio combined with faster digitization and download times makes Medium Resolution Mode ideal for finding and centering dim objects, and for imaging most objects. Additionally, a Low resolution mode is provided which bins the CCD 3x3 before readout. Low resolution mode is

## Section 5 – Advanced Imaging Techniques

sensational for displaying faint nebulosity with short exposure times. In Auto Resolution Mode, the camera and software will always use High Resolution for all imaging and display functions except when you are in Full Frame Focus Mode. It will then automatically switch to Low Resolution Mode. If you further select Planet Mode for focusing, the camera will switch back to High Resolution on the selected box area. The small pixel size, is best for critical focusing. Planet mode will result in fast digitization and download times since only a small portion of the frame is read out.

In general, you should pick a binning mode that yields stars with two to three pixels full width at half maximum. This is easily measured by using the crosshairs to determine the peak brightness of a relatively bright star, and determining the number of pixels between the 50% values on either side of the peak. More than 3 pixels per stellar halfwidth merely wastes sensitivity without improved resolution.

### 5.7. Flat Fielding Track and Accumulate Images

This section gives the step by step procedure for flat field correcting images taken using the Track and Accumulate command.

Flat field correcting images allow the user to remove the effects of CCD response non-uniformity (typically less than a few percent) and optical vignetting which for some optical systems can be as much as a 50% effect from center to edge. The CCDOPS software allows flat field correcting images using the Flat Field command, but some preparation must be made to use that command with Track and Accumulate images. Essentially you must prepare a special flat field correction image for Track and Accumulate images. This special preparation is necessary to have the same set of alignment and co-addition operations apply to the flat field file that have occurred in acquiring the Track and Accumulate image. In general, the following procedure should be followed when flat field correction of Track and Accumulate images is desired:

1. Take a normal flat field image using the Grab command. You can use the dusk sky or a neutral gray or white card held in front of the telescope. Try to adjust the illumination and/or exposure so that the build up of light in the image yields values that when co-added several times will not overflow 65,000 counts. The number of times the image will need to be co-added without overflowing is set by how many snapshots you intend to use in Track and Accumulate. A good goal is to try and attain a maximum level in the flat field image of 1,000 to 2,000 counts which will allow co-addition 32 times without overflow.

*Note: You will have to take a new flat field image anytime you change the optical configuration of your telescope such as removing and replacing the optical head in the eyepiece holder.*

2. Save the flat field image on your disk using the Save command. In the following discussions this flat field file will be referred to as FLAT.
3. Take your Track and Accumulate image using the Track and Accumulate command and save it on the disk using the Save command. In the following discussions this Track and Accumulate image file will be referred to as IMAGE.

## Section 5 – Advanced Imaging Techniques

4. Immediately after saving the IMAGE use the Save Track List command on the PC or activate the Track List window on the Mac and use the Save command to save the Track and Accumulate track list. The track list is a file that describes what alignment operations were done to the individual components of IMAGE to achieve the end result. In the following discussions this track list file will be referred to as TRACK.
5. Repeat steps 3 and 4 as many times as desired for all the objects you wish to image, each time choosing a set of corresponding new names for the IMAGE and TRACK files.
6. You will now create a combined flat field image for each Track and Accumulate image you captured. Invoke the Add by Track List command. The software will bring up a file directory dialog showing all the track list files. Select the TRACK file corresponding to the image you wish to correct. The software will load the TRACK file and present you with another file directory dialog showing all the images. Select the appropriate FLAT image. The software will align and co-add the FLAT image using the same operations it performed on the Track and Accumulate image. Finally save the combined flat field image using the Save command. In the following discussions this combined flat field image will be referred to as COMBINED-FLAT. Repeat this step for each of the TRACK files using a corresponding name for the COMBINED-FLAT image.
7. You will now flat field correct the Track and Accumulate image with the combined flat field image. Use the Open command to load the IMAGE file, then use the Flat Field command. The software will present you with a file directory dialog where you should select the corresponding COMBINED-FLAT image. After the software has finished correcting the image you can view the results and save the flat field corrected image with the Save command. This image will be referred to as the CORRECTED-IMAGE file. Repeat this step for each of the IMAGE files using the corresponding COMBINED-FLAT image.

At SBIG we have adopted the following naming convention for our various image and related files. If it helps you organize your files please feel free to adopt it or any method you feel helps sort out the process of naming files:

<u>Image type</u>	<u>Name</u>
Uncorrected image (IMAGE)	XXXXXXXX. (blank extension)
Flat field file (FLAT)	FLATXXXX. (blank extension)
Track list file (TRACK)	XXXXXXXX.TRK
Combined flat field (COMBINED-FLAT)	FLATXXXX.C
Flat field corrected image (CORRECTED-IMAGE)	XXXXXXXX.F

### 5.8. Tracking Functions

The CCDOPS software allows your ST-4020XM, ST-1301XE, ST-1001XE, ST-11000XM and ST-6303XE to be used as an autoguider or self-guided imager. It does not function as a stand-alone



## Section 5 - Advanced Imaging Techniques

autoguider like the ST-4, but instead requires using a PC to perform the function. These cameras have considerably better sensitivity than the ST-4.

CCD autoguiders alleviate you from having to stare down the eyepiece for hours at a time while guiding astrophotographs. They are not the end-all, cure-all approach to telescope mechanical problems, though. You still need a good polar alignment and a rigid mount between the guide scope and the main scope or you need to use an off-axis guider, with all its inherent difficulties. A good declination drive, free of backlash, is desirable although not absolutely necessary. Finally, modern drive correctors with periodic error correction (PEC) or permanent periodic error correction (PPEC) will ease the difficulty of achieving good results.

*The moral of the story is don't count on the CCD autoguider to fix all your problems.  
The better the drive, the better results you will obtain.*

Using the CCD as an autoguider requires interfacing the CPU's relay port to your hand controller (as discussed in section 4.4) and then training the CCD system on your telescope. This is done with the Calibrate Track command. Focus your system and then find and center on a moderately bright calibration star (1000 to 20,000 peak counts will do) without any nearby neighboring stars of similar brightness. Then execute Calibration command. It takes a sequence of five images. In the first image it determines the pixel position of the calibration star. In the four subsequent images, the software, in sequence, activates each of the telescope's four correction directions, measuring the displacement of the calibration star. From this calibration information, the software is able to calculate a precise correction when the guide star moves away from its intended position.

At the start, you should pick a calibration star with roughly the same declination as the intended object since the telescope's correction speeds vary with declination. As you get used to the tracking functions you can calibrate on a star near the celestial equator and have the software adjust for different declinations for you.

The tracking functions in CCDOPS are accessed through the Track menu. The Calibrate Track command, as described above, is used to calibrate your telescope's drive corrector. Once that is done, the Track command, which you would use for autoguiding astrophotographs, allows you to select a guide star in the field of view, and then repeatedly takes images, measuring the guide star's position and hence guiding error, and corrects the telescope.

The Track and Accumulate command, discussed in section 3.9.2, also has provisions for making telescope corrections between images. This is necessary only if your drive has a large amount of long term drift, which results in Track and Accumulate images that are reduced in width.

Finally, the Tracking Parameters command allows you to fine tune the CCDOPS tracking performance. You can deactivate the RA or DEC corrections or even deactivate both, a feature that can be used to monitor the uncorrected tracking accuracy of your drive. You can also fine tune the correction speeds if you find the telescope is consistently over or under correcting.



## Section 6 – Accessories for your CCD Camera

### 6. Accessories for your CCD Camera

This section briefly describes the different accessories available for your CCD camera.

#### 6.1. Water Cooling

The Research Series cameras are equipped with two-stage cooling and a new heat exchanger design that is ready to accept water circulation for additional cooling efficiency, if needed in warm climates.

The camera can be used either with or without flowing water. Water-cooling is probably not necessary for most users when the air temperature is below 10 degrees C (50 degrees F), since the dark current is fairly low already. Think of it as a summertime accessory! We do not recommend use of water cooling below freezing temperatures, where antifreeze must be added to the water. It is simply not necessary then.

There is no problem using the camera at any time without water circulation. Adding water circulation simply improves the cooling performance.

You may supply your own pump and tubing or use the optional pump and tubing available from SBIG. To operate the camera with water circulation using the optional pump available from SBIG, start with the camera at the same level as the water reservoir. Connect all the hoses, and make sure the water return goes back into the reservoir. Turn on the pump, and let the flow establish itself through the hoses. Be sure to check for leaks!

Once you have established water circulation, turn on the TE cooler to 100% by giving it a target temperature of -50 degrees. Wait for about 10 to 20 minutes for the system to stabilize at the lowest temperature it can achieve. Examine the camera temperature, and reset the set point to 3 degrees C above the current temperature. This 3 degree temperature margin will enable the camera to regulate the temperature accurately.

When using water cooling, avoid the temptation to put ice in the water to get the camera even colder. If colder water is used, the head may fog or frost up, depending on the dew point. At the end of the evening, stop the pump, and raise the outlet hose above the camera to let all the water drain out of the system. Blowing it out with gently pressure helps clear the water. You can leave the hoses full of water, but if a leak occurs while you're not there you may have a problem.

When packing the camera for a long time, or at the end of summer, disconnect the hoses and blow out the heat sink to allow the enclosed spaces to dry out and minimize long term corrosion.

#### 6.2. Tri-color Imaging

You can make splendid color images with your CCD camera by installing the optional color filters into the filter carousel. The LRGBC filter set allows you to take images in red, green and blue light as well as UV and IR blocked or unblocked clear (luminance) images of the same object. When these images are aligned and processed a full color image results.

## Section 6 – Accessories for your CCD Camera

### 6.3. Camera Lens Adapter

A camera lens adapter is available for the Research Series cameras. The camera lens adapter allows you to mount a Nikon 35mm camera lens in place of the telescope for very wide field views of the night sky or for daytime terrestrial imaging

### 6.4. Focal Reducers

Several third party vendors, including Astro-Physics, Takahashi, Optec, Celestron and Meade, make focal reducers that could be used with the Research Series cameras. Focal reducers may cause some vignetting, however.

### 6.5. Flat Field Correctors

For wide field imaging through fast refractors you may also want to add a flat field corrector lens to keep stars round near the edge of the field of view of the larger CCDs. Check with your telescope manufacturer for these accessories.

### 6.6. Third Party Products and Services

There are numerous third party products and services available directed to the CCD user. Appendix E mentions a few vendors who have supported SBIG products just to give you an idea of the ever increasing interest in this new technology.

#### 6.6.1. Windows Software

Our CCDOPS version 5 software is compatible with Windows 95/98/2000/Me/NT/XP. However, many users also want additional image processing or analytical features not found in CCDOPS. Therefore, since January 2001, all SBIG cameras also include CCDSoftV5 which is a joint software development of SBIG and Software Bisque. There are also several other commercial Windows programs available which include a stellar database, telescope control for computerized telescopes like the Meade LX200, and CCD camera functions in an integrated package.

#### 6.6.2. Image Processing Software

There are a host of image processing software packages capable of reading and processing FITS and TIFF files and many packages will read and process native SBIG image formats as well. In addition to commercial software, a number of web sites offer public domain and shareware programs.

#### 6.6.3. Getting Hardcopy

For the best quality hard copy, save the files in TIFF format and send a copy of the file on a disk to a photo lab which offers printing of digital images. The Windows version of CCDOPS allows for printing of the images. There are a number of third party software programs for the

## Section 6 - Accessories for your CCD Camera

PC and photo quality color desktop printers that will product photo like prints of your digital images.

### **6.7. SBIG Technical Support**

If you have any unanswered questions about the operation of your CCD camera system or have suggestions on how to improve it please don't fail to contact us. We appreciate all your comments and suggestions. Additionally if you are interested in writing software supporting SBIG cameras, we offer technical support regarding our file formats found in Appendix B, and Technical Notes regarding the camera command protocol which we will make available upon request.



## Section 8 - Glossary

### 7. Common Problems

This section discusses some of the more common problems others have encountered while using our CCD cameras. You should check here if you experience difficulties, and if your problem still persists please contact us to see if we can work it out together.

**Achieving Good Focus** - Achieving a good focus is one of the most difficult areas in working with CCD cameras due to the lack of real time feedback when focusing. Focus can take a good deal of time, and as with all forms of imaging, focus is critical to getting the most out of your camera.

Once you have achieved a good focus with your system, it can be very useful for future observing sessions to scribe an eyepiece or mark down or log positions of each component so the next time you will at least be close to focus at the start.

If you know where the focal plane lies for your telescope, you can use Table 3.1 to calculate exactly where the CCD is with respect to your system. By placing the CCD close to the focal plane initially, you can save a lot of time.

The best kind of object to focus on is a star. As you converge towards focus, more light from the star will be concentrated onto one pixel. Thus, watching your peak reading while focusing and focusing for a maximum reading is a good way to get best focus. This is how we do it. It helps to have a dial or indicator on the focus knob so you can rapidly return to the best point after going through focus.

**Elongated Guided Images** - When using Track and Accumulate or Self Guiding, if you notice guiding errors resulting in elongated star images, you are probably using too long a snapshot time. If the snapshot time is longer than the amount of time your drive can track unguided with acceptable guiding errors, you will see elongated stars in your final images. If your snapshot times are getting down to 30 seconds or less you should improve your drive.

If you are using your camera as an autoguider for film photography and are noticing unacceptable guiding errors, please check the following before calling SBIG:

1. Can you move the telescope using the Move command? This is an indicator as to whether or not you are properly connected to your drive system via the relay cable from the CPU.
2. Be sure that your calibration time gives at least 10 to 50 pixels of movement for each step of the Calibrate Track command.
3. Check for flexure between the CCD camera head and your system. Check for flexure between the guide scope or off-axis guider and your telescope system. This is a very common source of guiding errors. A very small movement of the CCD head with respect to the guide scope during an exposure can cause unacceptable streaking.
4. If your mount is stable, try longer exposure times while tracking to average out the atmospheric effects.

**Finding Objects** - The easiest method of finding objects is to use a reticule eyepiece, if the object is bright enough to see. Pull the CCD optical head from the eyepiece holder and

## Section 8 - Glossary

insert a 12-20mm eyepiece, focusing the eyepiece by sliding it in and out of the eyepiece holder, not by adjusting the telescope's focus mechanism. Center the object carefully (to within 10% of the total field) and then replace the CCD optical head. Since the head was fully seated against the eyepiece holder when you started, fully seating it upon replacement will assure the same focus.

If the object is too dim to see visually you will have to rely on your setting circles. Go to a nearby star or object that is easily visible and center that object in the CCD image. Calibrate your RA setting circle on the known object's RA and note any DEC errors. Reposition the telescope at the intended object, using the correct RA setting and the same DEC offset noted with the calibration object. Try a ten second or one minute exposure and hopefully you will have winged the object. If not you will have to hunt around for the object. You can use the Focus mode in Low resolution mode for this and hopefully you won't have to search too far. Check in DEC first, as DEC setting circles are often smaller and less accurate.

**Telescope Port doesn't Move Telescope** - If you find the camera is not moving the telescope for Tracking, Track and Accumulate or Self Guiding you should use the Move Telescope command with a several second period to isolate the problem down to a specific direction or directions. If you set the Camera Resolution to the Low mode in the Camera Setup Command, you can move the telescope and Grab an image fairly quickly to detect movement of the telescope pointed at a moderately bright star. Try each of the four directions and see which ones move and which ones don't. At this point the most likely culprit is the hand controller modification. Trace the signals from the camera's telescope connector back through the hand controller, paying particular attention to the offending wires.

**Can't Reach Low Setpoint Temperatures** - If you find that the camera isn't getting as cold as expected the problem is probably increased ambient temperatures. While these cameras have temperature regulation, they still can only cool a fixed amount below the ambient temperature (30 to 40 °C). Lowering the ambient temperature allows the cameras to achieve lower setpoint temperatures.

**CCD Frosts** - If your camera starts to frost after a year of use it's time to regenerate the desiccant as described in Appendix B. This is a simple matter of unscrewing the desiccant container and baking it (without the little O-ring) in an oven at 350°F for 4 hours.

**No Image is Displayed** - Try the Auto Contrast setting or use the crosshairs to examine the image pixel values and pick appropriate values for the Background and Range parameters.

**Horizontal Faint Light Streaks in Image** - some PCs apparently have the mouse generate non-maskable interrupts when moved. These interrupts can slightly brighten the line being read out. If this occurs, do not move the mouse during read out.

### 8. Glossary

**Antiblooming Gate** - When a CCD pixel has reached its full well capacity, electrons can effectively spill over into an adjoining pixel. This is referred to as blooming. Kodak



## Section 8 - Glossary

CCDs with the antiblooming option can be used to help stop or at least reduce blooming when the brighter parts of the image saturate.

**Astrometry** - Astrometry is the study of stellar positions with respect to a given coordinate system.

**Autoguider** - All SBIG CCD cameras have auto guiding or "Star Tracker" functions. This is accomplished by using the telescope drive motors to force a guide star to stay precisely centered on a single pixel of the CCD array. The camera has four relays to control the drive corrector system of the telescope. The CCD camera head is installed at the guide scope or off axis guider in place of a guiding eyepiece.

**CCD** - The CCD (Charged Coupled Device) is a flat, two dimensional array of very small light detectors referred to as pixels. Each pixel acts like a bucket for electrons. The electrons are created by photons (light) absorbed in the pixel. During an exposure, each pixel fills up with electrons in proportion to the amount of light entering the pixel. After the exposure is complete, the electron charge buildup in each pixel is measured. When a pixel is displayed at the computer screen, its displayed brightness is proportional to the number of electrons that had accumulated in the pixel during the exposure.

**Dark Frame** - The user will need to routinely create image files called Dark Frames. A Dark Frame is an image taken completely in the dark. The shutter covers the CCD. Dark Frames are subtracted from normal exposures (light frames) to eliminate fixed pattern and dark current noise from the image. Dark Frames must be of the same integration time and temperature as the light frame being processed.

**Dark Noise** - Dark Noise or Dark Current is the result of thermally generated electrons building up in the CCD pixels during an exposure. The number of electrons due to Dark Noise is related to just two parameters; integration time and temperature of the CCD. The longer the integration time, the greater the dark current buildup. Conversely, the lower the operating temperature, the lower the dark current. This is why the CCD is cooled for long integration times. Dark noise is a mostly repeatable noise source, therefore it can be subtracted from the image by taking a "Dark Frame" exposure and subtracting it from the light image. This can usually be done with very little loss of dynamic range.

**Double Correlated Sampling** - Double Correlated Sampling (DCS) is employed to lower the digitization errors due to residual charge in the readout capacitors. This results in lower readout noise.

**False Color** - False Color images are images that have had colors assigned to different intensities instead of gray levels.

**FITS Image File Format** - The FITS image file format (which stands for Flexible Image Transport System) is a common format supported by professional astronomical image processing programs such as IRAF and PC Vista. CCDOPS can save image files in this format but can not read them..

**Flat Field** - A Flat Field is a image with a uniform distribution of light entering the telescope. An image taken this way is called a flat field image and is used with CCDOPS to correct images for vignetting.

## Section 8 - Glossary

**Focal Reducer** - A Focal Reducer reduces the effective focal length of an optical system. It consists of a lens mounted in a cell and is usually placed in front of an eyepiece or camera. With the relatively small size of CCDs compared to film, focal reducers are often used in CCD imaging.

**Frame Transfer CCDs** - Frame Transfer CCDs are CCDs that have a metal mask over some portion (usually half) of the pixel array. The unmasked portion is used to collect the image. After the exposure is complete, the CCD can very quickly shift the image from the unmasked portion of the CCD to the masked portion, thus protecting the image from light which may still be impinging on the CCD. This acts as an electronic shutter.

**Full Well Capacity** - Full Well Capacity refers to the maximum number of electrons a CCD pixel can hold. This number is usually directly proportional to the area of the pixel.

**Histogram** - The Histogram is a table of the number of pixels having a given intensity for each of the possible pixel locations of the image file. Remember that, in the end, the image file is nothing more than a list of pixel values, one for each CCD pixel. These value numbers can be displayed in two formats; as a table or plotted as a graph.

**Light Frame** - The Light Frame is the image of an object before a Dark Frame has been subtracted.

**Photometry** - Photometry is the study of stellar magnitudes at a given wavelength or bandpass.

**Pixel Size** - The smallest resolution element of a CCD camera is the CCD pixel. The pixel sizes for each of the SBIG cameras are as follows:

Camera	Pixel Size (microns)
TC-237 Tracking CCD	7.4 x 7.4
STL-4020M	7.4 x 7.4
STL-1301E	16 x 16
STL-1001E	24 x 24
STL-11000M	9 x 9
STL-6303E	9 x 9

**Planet Mode** - Planet Mode is the most useful way to achieve focus. When you select Planet mode, a full frame is exposed, downloaded, and displayed on the computer monitor. A small window can be placed anywhere in the image area and the size of the window can be changed. Subsequent downloads will be of the area inside the box resulting in a much faster update rate.

**Quantum Efficiency** - Quantum Efficiency refers to the fractional number of electrons formed in the CCD pixel for a given number of photons. Quantum Efficiency is usually plotted as a function of wavelength.

**Readout Noise** - Readout noise is associated with errors generated by the actual interrogation and readout of each of the CCD pixels at the end of an exposure. This is the result of fixed pattern noise in the CCD, residual charge in the readout capacitors and to a small extent the noise from the A/D converter and preamplifier.

**Resolution Mode** - The resolution of a CCD camera is determined by pixel size. Pixel size can be increased by combining or binning more than one pixel and displaying it as one pixel. Doing so decreases the effective resolution but speeds up the download time of

## Section 8 - Glossary

the image. Maximum resolution is determined by the size of the individual CCD pixel. The Research Series cameras can run in High, Medium, Low and Auto resolution modes.

**Response Factor** - Response Factor is a multiplier used by CCDOPS to calibrate CCDOPS to a given telescope for photometric calculations. The Response Factor multiplied by 6700 is the number of photoelectrons generated in the CCD for a 0th magnitude star per second per square inch of aperture.

**Saturation** - Saturation refers to the full well capacity of a CCD pixel as well as the maximum counts available in the A/D converter. The pixel is saturated when the number of electrons accumulated in the pixel reaches its full well capacity. The A/D is saturated when the input voltage exceeds the maximum.

**Sky Background** - The sky background illumination or brightness is the number of counts in the image in areas free of stars or nebulosity and is due to city lights and sky glow. High levels of sky background can increase the noise in images just like dark current. For some objects deep sky filters can be used to reduce the sky background level.

**Seeing** - Seeing refers to the steadiness and the clarity of the atmosphere during an observing session.

**TE Cooler** - The TE Cooler is a Thermal Electric cooling device used to cool the CCD down to operating temperature. The CCD is mounted to the TE Cooler which is mounted to a heat sink, usually the camera head housing.

**TIFF Image File Format** - The TIFF image file format (which stands for Tagged Interchange File Format) was developed jointly by Microsoft and Aldus Corporations to allow easy interchange of graphics images between programs in areas such as presentation and desktop publishing. CCDOPS can save image files in this format but it can not read them.

**Track and Accumulate** - The Track and Accumulate function is a SBIG patented feature of CCDOPS that allows the user to automatically co-register and co-add (including dark frame subtraction) a series of images of an object. These exposures can be taken unguided as long as the "Snapshot time" does not exceed the length of time before tracking errors of your clock drive become apparent. This allows you to image and track without guiding or the need to connect the CCD Relay port to your drive motors.

**Track List** - The Track List is an ASCII file generated by CCDOPS during a Track and Accumulate session. The Track List logs all the corrections made by CCDOPS for each of the images. Track lists are required when flat fielding Track and Accumulate images.

**Tri-Color** - Tri-Color refers to color images created using three different colors mixed into a balanced color image using red, green and blue filters. An object is imaged three times, once with each color filter. The three images are then co-added and color balanced with the appropriate software.

**Vignetting** - Vignetting is obstruction of the light paths by parts of the instrument. It results in an uneven illumination of the image plane. The effects of vignetting can be corrected using flat field images.



## Appendix A - Connector Pinouts

### A. Appendix A - Connector and Cables

#### A.1. Connector Pinouts for the AO/SCOPE port:

Pin Number	Function
1	Chassis Ground
2	External CFW Pulse/ AO Data Out
3	Plus X (Active Low Open Collector) <sup>4</sup>
4	Plus Y (Active Low Open Collector)
5	Signal Ground
6	Minus X (Active Low Open Collector)
7	Minus Y (Active Low Open Collector)
8	+12 Volts Out (100mA max shared with I2C AUX)
9	+5 Volts Out (500mA max shared with I2C AUX)
Shell	Chassis Ground

*Table A1 Telescope Connector*

#### A.2. Connector Pinouts for the power jack:

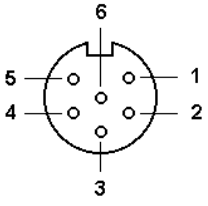
	<i>Pin Number</i>	<i>Function</i>
	Shell	Earth / Chassis Ground
	1,5,6	+12V, 6A
	2,3,4	DC Return

*Table A2 Power Connector Power Jack – Research Series Cameras*

#### A.3. Connector Pinouts for the I2C AUX port:

Pin Number	Function
1	+5V DC (500 mA max shared with AO7/CFW8)
2	Open collector output
3	Serial Clock
4	Serial Data
5	Signal Ground
6	TTL input
7	Open collector output
8	+12V DC (100mA max shared with AO7/CFW8)
9	+3.3V DC (500mA max)
Shell	Chassis Ground

*Table A3 I2C Accessory Port*

<sup>4</sup> The Open Collector outputs can sink 100 mA maximum

## Appendix A - Connector Pinouts

### A.4. SBIG Tracking Interface Cable (TIC-78)

Many of the newer telescopes have a phone-jack connector on the drive corrector for connecting directly to an SBIG camera or autoguider. You can interface these telescopes to the Telescope port with our TIC-78 (Tracking Interface Cable), or you can make your own cable. Figure A1 below shows the pinouts on some of these telescopes.

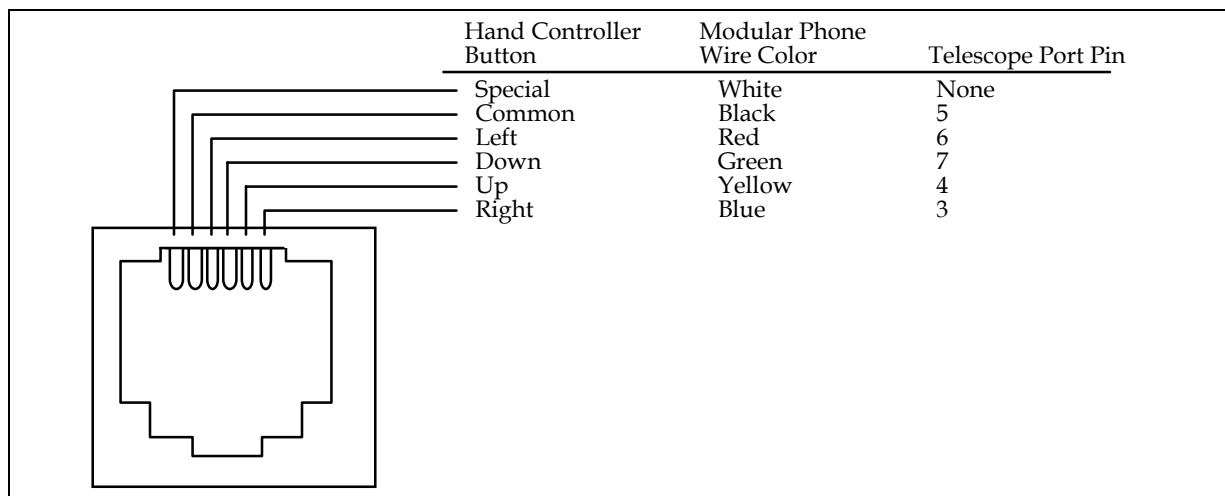

Figure A1 - CCD Connector for TIC Mating

Telescope electronic designs are changing rapidly. You should check with the manufacturer of your telescope for the actual pinouts of your particular model. If this TIC cable does not match your drive port, then you can use the information in Table A1 to make a cable to work with your specific telescope/drive system.

## Appendix B - Maintenance

### B. Appendix B - Maintenance

This appendix describes the maintenance items you should know about with your CCD camera system.

#### B.1. Cleaning the CCD and the Window

The design of SBIG cameras allows for cleaning of the CCD. The optical heads are not evacuated and are quite easy to open and clean. When opening the CCD chamber, one should be very careful not to damage the structures contained inside.

To open the CCD Chamber, remove the six screws that hold the 5 inch front cover in place. Remove the six screws and lift the front cover, exposing the structures inside. There is a rubber O-Ring that sets in the groove on the top of the Chamber housing.

The CCD array is protected by a thin cover glass that can be cleaned with Q-Tips and Isopropyl Alcohol. *Do not get alcohol on the shutter.* Dust on the CCD should be blown off. Use alcohol only if necessary. The optical window of the chamber housing can be cleaned the same way. When reinstalling the chamber housing, be very careful to make sure the O-ring is in the groove when seated.

#### B.2. Regenerating the Desiccant

This section describes the regeneration procedure for the desiccant used in the Research Series cameras. The desiccant absorbs moisture in the CCD chamber, lowering the dew point below the operating temperature of the cooled CCD, thus preventing the formation of frost. The desiccant is contained in a small cylindrical plug that screws into the chamber from the side. In normal operation the useful life of the desiccant is over a year. If the CCD chamber is opened often, the desiccant should be regenerated when frosting is noticed. Follow the procedure below to regenerate the desiccant:

1. Unscrew the desiccant container from the side of the chamber and remove the O-ring.
2. Plug the resulting hole in the chamber by placing a piece of black plastic tape over the opening to keep dust out while you are baking the desiccant.
3. Heat the desiccant container in an oven at 350°F (175 deg C) for 4 hours. The solder used to seal the can melts at 460 degrees F, so be sure to stay at least 50 degrees below this number. Preheating the oven to avoid hot spots is advised.
4. Replace the desiccant container into the rear of the camera, being careful to reinstall the O-ring and insure that it does not get pinched.
5. Expect the camera to take an hour or two to reach the frost free state. If it does seem to frost and you need to capture images, reduce your cooling to the zero degree C range - the CCD dark current will still be quite low.

## Appendix C - Capturing a Good Flat Field

### C. Appendix C - Capturing a Good Flat Field

This appendix describes how to take a good flat field. A good flat field is essential for displaying features little brighter than the sky background. The flat field corrects for pixel non-uniformity, vignetting, dust spots (affectionately called dust doughnuts), and stray light variations. If the flat field is not good it usually shows up as a variation in sky brightness from one side of the frame to the other.

#### C.1. Technique

The first consideration in capturing a flat field is to use the telescope-CCD combination in exactly the configuration used to collect the image. This means you probably have to capture the flat field at the telescope. Do not rotate the head between image and flat field, since the vignetting is usually slightly off center. Do not be tempted to build a little LED into the telescope or camera for doing flat fields; it doesn't work at all. The dust debris shadows would be different!

Arrange a light source such as a flashlight, two white cards, the telescope and CCD as shown in Figure D-1.

Figure D-1: Flat Field Geometry

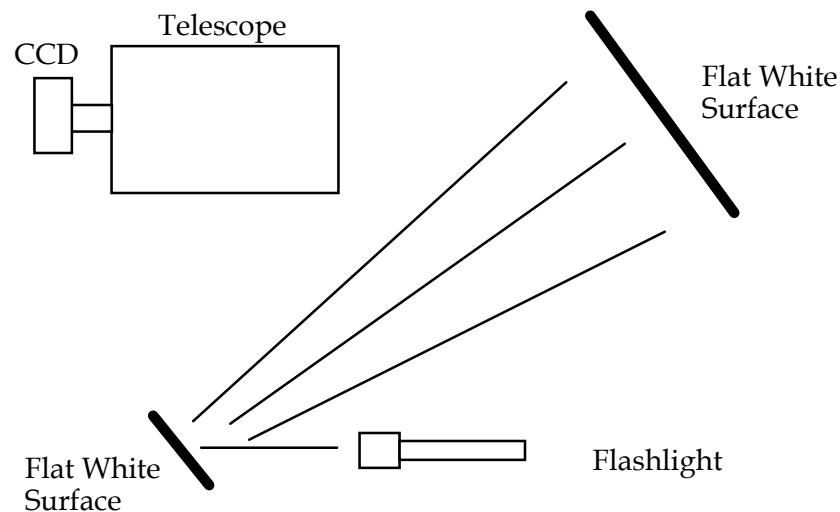

The key aspects of this geometry are that the reflection off two diffuse surfaces is used, and the large flat surface is square to the illumination from the small flat surface. When we do this, the first flat surface is typically a white T-shirt worn by the operator! Take care that no apparent shadows are cast onto the larger flat white surface. Use an exposure at the camera that yields an average light level equal to about half of full scale.



## Appendix E - Third Party Vendors Supporting SBIG Products

### D. Appendix D - Camera Specifications

Model STL-4020M Typical Specifications																															
<b>CCD SPECIFICATIONS</b>																															
<b>Imaging CCD</b>	Kodak Enhanced KAI-4020M (Class 2)																														
<b>Pixel Array</b>	2048 x 2048 pixels, 15.2 x 15.2 mm																														
<b>Total Pixels</b>	4.2 million																														
<b>Pixel Size</b>	7.4 x 7.4 microns																														
<b>Full Well Capacity (NABG)</b>	40,000 e <sup>-</sup>																														
<b>Dark Current</b>	1e <sup>-</sup> /pixel/second @ 0 degrees C																														
<b>Antiblooming</b>	ABG only																														
<b>READOUT SPECIFICATIONS</b>																															
<b>Shutter</b>	Electromechanical																														
<b>Exposure</b>	0.01 to 3600 seconds, 10ms resolution																														
<b>Correlated Double Sampling</b>	Yes																														
<b>A/D Converter</b>	16 bits																														
<b>A/D Gain</b>	0.72e <sup>-</sup> /ADU																														
<b>Read Noise</b>	<15e <sup>-</sup> RMS																														
<b>Binning Modes</b>	1 x 1, 2 x 2, 3 x 3																														
<b>Full Frame Download</b>	9.8 seconds																														
<b>SYSTEM SPECIFICATIONS</b>																															
<b>Cooling - standard</b>	Two-Stage Thermoelectric, Water Assist, -50 C from Ambient Typical																														
<b>Temperature Regulation</b>	±0.1°C																														
<b>Power</b>	10 - 18VDC, 12VDC nominal, Universal AC to 12VDC desktop supply																														
<b>Computer Interface</b>	USB 1.1																														
<b>Computer Compatibility</b>	Windows 95/98/NT/2000/Me/XP																														
<b>Guiding</b>	Dual CCD Self-Guiding Standard, Remote Guiding Head Optional																														
<b>PHYSICAL SPECIFICATIONS</b>																															
<b>Dimensions</b>	6.5 x 6 x 3.5" (16.5 x 15.2x8.9cm)																														
<b>Weight</b>	4 pounds (1.8 Kg) without filters																														
<b>Internal Filter Carousel</b>	5 positions for 48mm threaded cells or 2" unmounted filters (optional)																														
<b>Mounting</b>	2" nosepiece included																														
<b>Backfocus</b>	Approximately 1.7 inches (~4.3 cm) with 2" nosepiece attached																														
<p><b>KAI-4020M CCD Quantum Efficiency (Spectral Response)</b></p>	<p style="text-align: center;"><b>Quantum Efficiency STL-4020M</b></p> <table border="1"> <caption>Approximate data points from the Quantum Efficiency graph</caption> <thead> <tr> <th>Wavelength (nm)</th> <th>Quantum Efficiency (% QE)</th> </tr> </thead> <tbody> <tr><td>400</td><td>45</td></tr> <tr><td>450</td><td>55</td></tr> <tr><td>480</td><td>58</td></tr> <tr><td>500</td><td>55</td></tr> <tr><td>550</td><td>45</td></tr> <tr><td>600</td><td>35</td></tr> <tr><td>650</td><td>25</td></tr> <tr><td>700</td><td>20</td></tr> <tr><td>750</td><td>15</td></tr> <tr><td>800</td><td>10</td></tr> <tr><td>850</td><td>8</td></tr> <tr><td>900</td><td>6</td></tr> <tr><td>950</td><td>4</td></tr> <tr><td>1000</td><td>2</td></tr> </tbody> </table>	Wavelength (nm)	Quantum Efficiency (% QE)	400	45	450	55	480	58	500	55	550	45	600	35	650	25	700	20	750	15	800	10	850	8	900	6	950	4	1000	2
Wavelength (nm)	Quantum Efficiency (% QE)																														
400	45																														
450	55																														
480	58																														
500	55																														
550	45																														
600	35																														
650	25																														
700	20																														
750	15																														
800	10																														
850	8																														
900	6																														
950	4																														
1000	2																														

## Appendix E - Third Party Vendors Supporting SBIG Products

Model STL-11000M Typical Specifications																													
<b>CCD SPECIFICATIONS</b>																													
<b>Imaging CCD</b>	Kodak Enhanced KAI-11000M																												
<b>Pixel Array</b>	4008 x 2745 pixels, 36 x 24.7 mm																												
<b>Total Pixels</b>	11 million																												
<b>Pixel Size</b>	9 x 9 microns																												
<b>Full Well Capacity (NABG)</b>	50,000 e <sup>-</sup>																												
<b>Dark Current</b>	1.5 e <sup>-</sup> /pixel/sec @ 0 degrees C																												
<b>Antiblooming</b>	ABG only																												
<b>READOUT SPECIFICATIONS</b>																													
<b>Shutter</b>	Electromechanical																												
<b>Exposure</b>	0.01 to 3600 seconds, 10ms resolution																												
<b>Correlated Double Sampling</b>	Yes																												
<b>A/D Converter</b>	16 bits																												
<b>A/D Gain</b>	0.8e <sup>-</sup> /ADU																												
<b>Read Noise</b>	11e <sup>-</sup> RMS																												
<b>Binning Modes</b>	1 x 1, 2 x 2, 3 x 3																												
<b>Full Frame Download</b>	26 seconds																												
<b>SYSTEM SPECIFICATIONS</b>																													
<b>Cooling - standard</b>	Two-Stage Thermoelectric, Water Assist, -50 C from Ambient Typical																												
<b>Temperature Regulation</b>	±0.1°C																												
<b>Power</b>	10 - 18VDC, 12VDC nominal, Universal AC to 12VDC desktop supply																												
<b>Computer Interface</b>	USB 1.1																												
<b>Computer Compatibility</b>	Windows 95/98/NT/2000/Me/XP																												
<b>Guiding</b>	Dual CCD Self-Guiding Standard, Remote Guiding Head Optional																												
<b>PHYSICAL SPECIFICATIONS</b>																													
<b>Dimensions</b>	6.5 x 6 x 3.5" (16.5 x 15.2x8.9cm)																												
<b>Weight</b>	4 pounds (1.8 Kg) without filters																												
<b>Internal Filter Carousel</b>	5 positions for 48mm threaded cells or 2" unmounted filters (optional)																												
<b>Mounting</b>	2" nosepiece included																												
<b>Backfocus</b>	Approximately 1.7 inches (~4.3 cm) with 2" nosepiece attached																												
<p><b>KAI-11000M</b> Quantum Efficiency (Spectral Response)</p>	<p style="text-align: center;"><b>Quantum Efficiency STL-11000M</b></p> <table border="1" style="margin: auto; border-collapse: collapse;"> <caption>Approximate data points from the Quantum Efficiency graph</caption> <thead> <tr> <th>Wavelength (nm)</th> <th>Quantum Efficiency (% QE)</th> </tr> </thead> <tbody> <tr><td>400</td><td>45</td></tr> <tr><td>450</td><td>48</td></tr> <tr><td>500</td><td>50</td></tr> <tr><td>550</td><td>45</td></tr> <tr><td>600</td><td>38</td></tr> <tr><td>650</td><td>32</td></tr> <tr><td>700</td><td>25</td></tr> <tr><td>750</td><td>18</td></tr> <tr><td>800</td><td>12</td></tr> <tr><td>850</td><td>8</td></tr> <tr><td>900</td><td>5</td></tr> <tr><td>950</td><td>3</td></tr> <tr><td>1000</td><td>1</td></tr> </tbody> </table>	Wavelength (nm)	Quantum Efficiency (% QE)	400	45	450	48	500	50	550	45	600	38	650	32	700	25	750	18	800	12	850	8	900	5	950	3	1000	1
Wavelength (nm)	Quantum Efficiency (% QE)																												
400	45																												
450	48																												
500	50																												
550	45																												
600	38																												
650	32																												
700	25																												
750	18																												
800	12																												
850	8																												
900	5																												
950	3																												
1000	1																												

## Appendix E - Third Party Vendors Supporting SBIG Products

Model STL-6303E Typical Specifications																															
<b>CCD SPECIFICATIONS</b>																															
<b>Imaging CCD</b>	Kodak Enhanced KAF-6303E																														
<b>Pixel Array</b>	3060 x 2040 pixels, 27.5 x 18.4 mm																														
<b>Total Pixels</b>	6 million																														
<b>Pixel Size</b>	9 x 9 microns																														
<b>Full Well Capacity (NABG)</b>	100,000 e <sup>-</sup>																														
<b>Dark Current</b>	1e <sup>-</sup> /pixel/second @ 0 degrees C																														
<b>Antiblooming</b>	NABG standard, ABG optional																														
<b>READOUT SPECIFICATIONS</b>																															
<b>Shutter</b>	Electromechanical																														
<b>Exposure</b>	0.11 to 3600 seconds, 10ms resolution																														
<b>Correlated Double Sampling</b>	Yes																														
<b>A/D Converter</b>	16 bits																														
<b>A/D Gain</b>	2.3e <sup>-</sup> /ADU																														
<b>Read Noise</b>	15e <sup>-</sup> RMS																														
<b>Binning Modes</b>	1 x 1, 2 x 2, 3 x 3																														
<b>Full Frame Download</b>	14 seconds																														
<b>SYSTEM SPECIFICATIONS</b>																															
<b>Cooling - standard</b>	Two-Stage Thermoelectric, Water Assist, -50 C from Ambient Typical																														
<b>Temperature Regulation</b>	±0.1°C																														
<b>Power</b>	10 - 18VDC, 12VDC nominal, Universal AC to 12VDC desktop supply																														
<b>Computer Interface</b>	USB 1.1																														
<b>Computer Compatibility</b>	Windows 95/98/NT/2000/Me/XP																														
<b>Guiding</b>	Dual CCD Self-Guiding Standard, Remote Guiding Head Optional																														
<b>PHYSICAL SPECIFICATIONS</b>																															
<b>Dimensions</b>	6.5 x 6 x 3.5" (16.5 x 15.2x8.9cm)																														
<b>Weight</b>	4 pounds (1.8 Kg) without filters																														
<b>Internal Filter Carousel</b>	5 positions for 48mm threaded cells or 2" unmounted filters (optional)																														
<b>Mounting</b>	2" nosepiece included																														
<b>Backfocus</b>	Approximately 1.7 inches (~4.3 cm) with 2" nosepiece attached																														
<p>KAF-6303E Quantum Efficiency (Spectral Response)</p>	<p style="font-size: small;">Quantum Efficiency STL-6303E</p> <table border="1" style="font-size: x-small; margin: 0 auto;"> <caption>Approximate data points from the Quantum Efficiency graph</caption> <thead> <tr> <th>Wavelength (nm)</th> <th>% QE</th> </tr> </thead> <tbody> <tr><td>400</td><td>30</td></tr> <tr><td>450</td><td>45</td></tr> <tr><td>500</td><td>50</td></tr> <tr><td>550</td><td>65</td></tr> <tr><td>580</td><td>68</td></tr> <tr><td>600</td><td>65</td></tr> <tr><td>650</td><td>65</td></tr> <tr><td>700</td><td>55</td></tr> <tr><td>750</td><td>45</td></tr> <tr><td>800</td><td>30</td></tr> <tr><td>850</td><td>25</td></tr> <tr><td>900</td><td>15</td></tr> <tr><td>950</td><td>10</td></tr> <tr><td>1000</td><td>5</td></tr> </tbody> </table>	Wavelength (nm)	% QE	400	30	450	45	500	50	550	65	580	68	600	65	650	65	700	55	750	45	800	30	850	25	900	15	950	10	1000	5
Wavelength (nm)	% QE																														
400	30																														
450	45																														
500	50																														
550	65																														
580	68																														
600	65																														
650	65																														
700	55																														
750	45																														
800	30																														
850	25																														
900	15																														
950	10																														
1000	5																														

## Appendix E - Third Party Vendors Supporting SBIG Products

Model STL-1301E Typical Specifications																															
<b>CCD SPECIFICATIONS</b>																															
<b>Imaging CCD</b>	Kodak Enhanced KAF-1301E																														
<b>Pixel Array</b>	1280 x 1024 pixels, 20.5 x 16.4 mm																														
<b>Total Pixels</b>	1.3 million																														
<b>Pixel Size</b>	16 x 16 microns																														
<b>Full Well Capacity (NABG)</b>	150,000 e <sup>-</sup>																														
<b>Dark Current</b>	5.6 e <sup>-</sup> /pixel/second @ 0 degrees C.																														
<b>Antiblooming</b>	NABG standard, ABG optional																														
<b>READOUT SPECIFICATIONS</b>																															
<b>Shutter</b>	Electromechanical																														
<b>Exposure</b>	0.11 to 3600 seconds, 10ms resolution																														
<b>Correlated Double Sampling</b>	Yes																														
<b>A/D Converter</b>	16 bits																														
<b>A/D Gain</b>	2.3e <sup>-</sup> /ADU																														
<b>Read Noise</b>	15e <sup>-</sup> RMS																														
<b>Binning Modes</b>	1 x 1, 2 x 2, 3 x 3																														
<b>Full Frame Download</b>	3 seconds																														
<b>SYSTEM SPECIFICATIONS</b>																															
<b>Cooling - standard</b>	Two-Stage Thermoelectric, Water Assist, -50 C from Ambient Typical																														
<b>Temperature Regulation</b>	±0.1°C																														
<b>Power</b>	10 - 18VDC, 12VDC nominal, Universal AC to 12VDC desktop supply																														
<b>Computer Interface</b>	USB 1.1																														
<b>Computer Compatibility</b>	Windows 95/98/NT/2000/Me/XP																														
<b>Guiding</b>	Dual CCD Self-Guiding Standard, Remote Guiding Head Optional																														
<b>PHYSICAL SPECIFICATIONS</b>																															
<b>Dimensions</b>	6.5 x 6 x 3.5" (16.5 x 15.2x8.9cm)																														
<b>Weight</b>	4 pounds (1.8 Kg) without filters																														
<b>Internal Filter Carousel</b>	5 positions for 48mm threaded cells or 2" unmounted filters (optional)																														
<b>Mounting</b>	2" nosepiece included																														
<b>Backfocus</b>	Approximately 1.7 inches (~4.3 cm) with 2" nosepiece attached																														
<b>KAF-1301E Quantum Efficiency (Spectral Response)</b>	<div style="border: 1px solid black; padding: 10px;"> <p style="text-align: center; margin: 0;"><b>Quantum Efficiency STL-1301E</b></p> <table border="1" style="margin: 10px auto; border-collapse: collapse; font-size: small;"> <caption>Approximate Quantum Efficiency Data for KAF-1301E</caption> <thead> <tr> <th>Wavelength (nm)</th> <th>Quantum Efficiency (%QE)</th> </tr> </thead> <tbody> <tr><td>400</td><td>40</td></tr> <tr><td>450</td><td>50</td></tr> <tr><td>500</td><td>55</td></tr> <tr><td>550</td><td>65</td></tr> <tr><td>580</td><td>75</td></tr> <tr><td>600</td><td>70</td></tr> <tr><td>650</td><td>65</td></tr> <tr><td>700</td><td>60</td></tr> <tr><td>750</td><td>50</td></tr> <tr><td>800</td><td>50</td></tr> <tr><td>850</td><td>40</td></tr> <tr><td>900</td><td>30</td></tr> <tr><td>950</td><td>20</td></tr> <tr><td>1000</td><td>10</td></tr> </tbody> </table> </div>	Wavelength (nm)	Quantum Efficiency (%QE)	400	40	450	50	500	55	550	65	580	75	600	70	650	65	700	60	750	50	800	50	850	40	900	30	950	20	1000	10
Wavelength (nm)	Quantum Efficiency (%QE)																														
400	40																														
450	50																														
500	55																														
550	65																														
580	75																														
600	70																														
650	65																														
700	60																														
750	50																														
800	50																														
850	40																														
900	30																														
950	20																														
1000	10																														

## Appendix E - Third Party Vendors Supporting SBIG Products

Model STL-1001E Typical Specifications																													
<b>CCD SPECIFICATIONS</b>																													
<b>Imaging CCD</b>	Kodak Enhanced KAF-1001E																												
<b>Pixel Array</b>	1024 x 1024 pixels, 24.6 x 24.6 mm																												
<b>Total Pixels</b>	1.0 million																												
<b>Pixel Size</b>	24 x 24 microns																												
<b>Full Well Capacity (NABG)</b>	150,000 e <sup>-</sup>																												
<b>Dark Current</b>	34 e <sup>-</sup> /pixel/second at 0 degrees C (~1e <sup>-</sup> /pixel/second at -30 degrees C)																												
<b>Antiblooming</b>	NABG only																												
<b>READOUT SPECIFICATIONS</b>																													
<b>Shutter</b>	Electromechanical																												
<b>Exposure</b>	0.11 to 3600 seconds, 10ms resolution																												
<b>Correlated Double Sampling</b>	Yes																												
<b>A/D Converter</b>	16 bits																												
<b>A/D Gain</b>	2.2e <sup>-</sup> /ADU																												
<b>Read Noise</b>	15e <sup>-</sup> RMS																												
<b>Binning Modes</b>	1 x 1, 2 x 2, 3 x 3																												
<b>Full Frame Download</b>	2.5 seconds																												
<b>SYSTEM SPECIFICATIONS</b>																													
<b>Cooling - standard</b>	Two-Stage Thermoelectric, Water Assist, -50 C from Ambient Typical																												
<b>Temperature Regulation</b>	±0.1°C																												
<b>Power</b>	10 - 18VDC, 12VDC nominal, Universal AC to 12VDC desktop supply																												
<b>Computer Interface</b>	USB 1.1																												
<b>Computer Compatibility</b>	Windows 95/98/NT/2000/Me/XP																												
<b>Guiding</b>	Dual CCD Self-Guiding Standard, Remote Guiding Head Optional																												
<b>PHYSICAL SPECIFICATIONS</b>																													
<b>Dimensions</b>	6.5 x 6 x 3.5" (16.5 x 15.2x8.9cm)																												
<b>Weight</b>	4 pounds (1.8 Kg) without filters																												
<b>Internal Filter Carousel</b>	5 positions for 48mm threaded cells or 2" unmounted filters (optional)																												
<b>Mounting</b>	2" nosepiece included																												
<b>Backfocus</b>	Approximately 1.7 inches (~4.3 cm) with 2" nosepiece attached																												
<b>KAF-1001E Quantum Efficiency (Spectral Response)</b>	<p style="text-align: center;"><b>Quantum Efficiency STL-1001E</b></p> <table border="1" style="margin: auto; border-collapse: collapse;"> <caption>Approximate data points from the Quantum Efficiency graph</caption> <thead> <tr> <th>Wavelength (nm)</th> <th>Quantum Efficiency (%)</th> </tr> </thead> <tbody> <tr><td>400</td><td>40</td></tr> <tr><td>450</td><td>50</td></tr> <tr><td>500</td><td>60</td></tr> <tr><td>550</td><td>75</td></tr> <tr><td>600</td><td>65</td></tr> <tr><td>650</td><td>65</td></tr> <tr><td>700</td><td>60</td></tr> <tr><td>750</td><td>50</td></tr> <tr><td>800</td><td>50</td></tr> <tr><td>850</td><td>40</td></tr> <tr><td>900</td><td>30</td></tr> <tr><td>950</td><td>20</td></tr> <tr><td>1000</td><td>10</td></tr> </tbody> </table>	Wavelength (nm)	Quantum Efficiency (%)	400	40	450	50	500	60	550	75	600	65	650	65	700	60	750	50	800	50	850	40	900	30	950	20	1000	10
Wavelength (nm)	Quantum Efficiency (%)																												
400	40																												
450	50																												
500	60																												
550	75																												
600	65																												
650	65																												
700	60																												
750	50																												
800	50																												
850	40																												
900	30																												
950	20																												
1000	10																												

## Appendix E - Third Party Vendors Supporting SBIG Products

### E. Appendix E - Third Party Vendors Supporting SBIG Products

Company / Author	Product	Notes
<b>Software Bisque</b> 912 12th Street Golden, CO 80401-1114 USA Sales: (800) 843-7599 International: (303) 278-4478 Facsimile: (303) 278-0045 E-mail Sales: <a href="mailto:bisque@bisque.com">bisque@bisque.com</a> E-mail Support: <a href="mailto:support@bisque.com">support@bisque.com</a> Web site: <a href="http://www.bisque.com">www.bisque.com</a>	CCDSoftV5, TheSky, Orchestrate, T-point, Paramount	Camera control, Image Processing, Astrometry, Minor Planet Searches, Planetarium and Charting, Scripting, Remote operation and telescope control. Robotic mounts. Authorized SBIG Dealer
<b>Diffraction Ltd.</b> 100 Craig Henry Drive, Unit 106, Ottawa, ON, K2G 5W3, Canada Telephone (613) 225-2732 FAX (613) 225-9688 E-mail Sales: <a href="mailto:sales@cyanogen.com">sales@cyanogen.com</a> E-mail Support: <a href="mailto:support@cyanogen.com">support@cyanogen.com</a> Web site: <a href="http://www.cyanogen.com">www.cyanogen.com</a>	Maxim DL.CCD	Image Processing, Camera Control software Authorized SBIG Dealer
<b>Axiom Research</b> 1830 East Broadway Blvd, Suite 124-202 Tucson, AZ 85719 Voice 520-323-8600 Fax 520-822-1435 E-mail Sales <a href="mailto:sales@axres.com">sales@axres.com</a> E-mail Support <a href="mailto:support@axres.com">support@axres.com</a> Web <a href="http://www.axres.com">http://www.axres.com</a>	Mira software	Camera control, Image processing, analysis, spectroscopy
<b>Axilone Multimedia</b> 18, ch. des Ajones, 31470 Saint-Lys FRANCE Phone: +33 5 34 47 20 52 Fax: +33 5 34 47 10 20 E-mail: <a href="mailto:prism@axilone.com">prism@axilone.com</a>	Prism 5	Image processing, camera control
<b>M.S.B.</b> di Fabio Cavicchio, Via Romea Vecchia 67, Classe, 48100 Ravenna RA. P.IVA 01379350398, TEL/FAX +39 0544 473589 Mobile +39 0339 2739548 E-Mail <a href="mailto:msbsoftware@tin.it">msbsoftware@tin.it</a> , <a href="mailto:msb@sira.it">msb@sira.it</a> Web site: <a href="http://www.msb-astroart.com">http://www.msb-astroart.com</a>	Astroart	Image processing software and camera control. FITS viewer
<b>New Astronomy Press,</b> Ron Wodaski PO Box 1766, Duvall, WA 98019 E-mail: <a href="mailto:support@newastro.com">support@newastro.com</a> FAX: 425-844-1535 Web site: <a href="http://www.newastro.com">http://www.newastro.com</a>	The New Astronomy	Book: Basics of CCD Imaging, background and techniques.
<b>The Minor Planet Observer,</b> Brian Warner e-mail: <a href="mailto:brianw_mpo@compuserve.com">brianw_mpo@compuserve.com</a> Web site: <a href="http://www.minorplanetobserver.com">http://www.minorplanetobserver.com</a>	Minor Planet Observer software	Astrometry, Minor planet searches

## Appendix E - Third Party Vendors Supporting SBIG Products

<p><b>Bruce Johnston Computing</b>  7124 Cook Rd.  Swartz Creek, MI 48473 U.S.A.  Phone: 810-635-9191 Fax: 1-810-750-1761  E-mail: <a href="mailto:BJohns7764@aol.com">BJohns7764@aol.com</a>  Web site: <a href="http://members.aol.com/bjohns7764">http://members.aol.com/bjohns7764</a></p>	<p>MexaFix  Software</p>	<p>Image processing</p>
<p><b>Phase Space Technology</b>  Phone: +61 3 9735 2270 Fax: +61 3 9739 4996  Web site: <a href="http://www.phasespace.com.au">http://www.phasespace.com.au</a>  E-mail Support: <a href="mailto:support@phasespace.com.au">support@phasespace.com.au</a>  E-mail General: <a href="mailto:pst@phasespace.com.au">pst@phasespace.com.au</a>  E-mail Orders: <a href="mailto:orders@phasespace.com.au">orders@phasespace.com.au</a></p>	<p>Astra Image</p>	<p>Image Processing  Software</p>
<p><b>Steve Mandel</b>  Hidden Valley Observatory  1425 Hidden Valley Rd., Soquel, CA 95073  E-mail: <a href="mailto:steve@galaxyimages.com">steve@galaxyimages.com</a>  Web: <a href="http://www.galaxyimages.com/ccdwidefield.html">http://www.galaxyimages.com/ccdwidefield.html</a></p>	<p>Mandel Wide  Field Adapter</p>	<p>Nikon lens adapter for  SBIG color filter wheel</p>
<p><b>Dr. Brady Johnson</b>  E-mail: <a href="mailto:bradyjohnson@rogers.com">bradyjohnson@rogers.com</a>  Web site:  <a href="http://members.rogers.com/bradyjohnson/widefield.htm">http://members.rogers.com/bradyjohnson/widefield.htm</a></p>	<p>Johnson  Wide Field  Adapter</p>	<p>Pentax, Olympus and  Minolta lens adapters for  SBIG color filter wheel</p>
<p><b>Astro-Physics, Inc.</b>  11250 Forest Hills Road, Rockford, IL 61115, U.S.A.  Phone: 815-282-1513 Fax: 815-282-9847  E-mail: <a href="mailto:info@astro-physics.com">info@astro-physics.com</a>  Web site: <a href="http://www.astro-physics.com">http://www.astro-physics.com</a></p>	<p>APO  Refractors  and mounts</p>	<p>4" to 6" APO refractors  and GOTO mounts.  Authorized SBIG OEM</p>
<p><b>RC Optical Systems</b>  Brad Ehrhorn  3507 Kiltie Loop, Flagstaff, AZ 86001  Tel: (928) 773-7584  E-mail: <a href="mailto:info@rcopticalsystems.com">info@rcopticalsystems.com</a>  Web site: <a href="http://www.rcopticalsystems.com/index.html">http://www.rcopticalsystems.com/index.html</a></p>	<p>Ritchey-  Chretien  telescopes</p>	<p>RC Telescopes and  accessories for CCD  imaging. Authorized  SBIG OEM</p>
<p><b>Astro Works Corporation</b>  P.O. Box 699, Aguila, Arizona 85320  Tel: (928) 685-2422  Web site: <a href="http://www.astroworks.com">http://www.astroworks.com</a></p>	<p>Centurion 18  telescope</p>	<p>18" F/2.8 telescope made  specifically for CCD  imaging. Authorized  SBIG OEM</p>

**Disclaimer:** Mention is made of third party vendors in this section as a courtesy only. These vendors are independent companies and/or individuals. SBIG does not endorse or support any particular company, product or service by virtue of mentioning them in this section. SBIG is not responsible for the use of any product or service mentioned in this section that is not manufactured or made by SBIG.





Index

- A/D converter, 40, 59
- accessories, 70
- antiblooming, 61, 74
- Antiblooming Gate (def), 74
- astrometric measurements, 75
- Astrometry (def), 75
- astrophotography, 44
- atmospheric effects, 49
- auto contrast, 50
- Auto Grab Command, 53
- autoguider, 40, 52, 55, 66, 75
- Autoguider (def), 75
- background parameter, 50
- battery operation, 47, 55
- binning, 43
- Calibrate Track Command, 52, 67
- calibration star, 67
- camera lens adapter, 63, 70
- Camera Setup Commands, 51
- CCD, 40, 43
  - (def), 75
  - cameras, 37, 38, 41, 47, 55, 58, 59
  - cleaning, 81, 82
  - detector, 37, 39, 55
- CCDOPS software, 40
- centering objects, 49
- cleaning the CCD, 81, 82
- clock drivers, 40
- co-add images, 37, 51, 55
- cold pixels, 50
- color filter wheel, 69
- color images, 45
- color table, 75
- commands
  - Auto Grab, 53
  - Calibrate Track, 52, 67
  - Dark Subtract, 50
  - Focus, 48, 51
  - Grab, 49, 50, 63
  - Track, 67
  - Track and Accumulate, 51, 63, 67
  - Tracking Parameters, 67
- Commands
  - Establish COM Link, 48
  - PC Setup, 48
- communications link, 47
- connector
  - Telescope, 79
- connector (CPU)
  - RELAYS, 55, 67
- cooling, 41, 77
- co-register images, 51, 55
- crop, 50
- crosshairs, 50
- dark current, 41
- dark frame, 40, 42, 47, 49, 50
- Dark Frame (def), 75
- Dark Noise (def), 75
- Dark Subtract Command, 50
- dark subtracted, 42, 47, 50
- DCS, 41, 75
- Declination, 55, 67, 74
- desiccant, 81
- Diffuse Magnitude, 50
- diffuser, 48
- Dim mode, 51
- displaying images, 50
- double correlated sampling, 41
- Double Correlated Sampling (def), 75
- drive corrector, 52
- electromechanical shutter, 59
- electronic images, 44
- electronic shutter, 59
- Establish COM Link Command, 48
- eyepiece, 49
- eyepiece holder, 47
- eyepiece projection, 70
- eyepiece tube, 48
- False Color (def), 75
- field of view, 43, 60, 67
- film, 37, 42, 43
- film grain, 42
- filter wheel, 45
- filters, 45, 50, 69
- finding objects, 49
- fine focus, 48
- FITS format (def), 75
- flat field, 42, 50, 64, 65
- Flat Field (def), 75
- flip, 50
- focal length, 21
- focal reducer, 70

## Index

- Focal Reducer (def), 76
- focus
  - Dim mode, 49, 51
  - fine, 48
  - Full frame mode, 49
  - Full Frame mode, 51
  - peak, 49
  - Planet mode, 49, 51, 76
- Focus Command, 48, 51
- focus mode, 48, 51
- Focusing, 48
- Frame Transfer CCDs, 38
- Frame Transfer CCDs (def), 76
- frost, 40
- Full Frame CCDs, 38
- full well capacity, 60
- Full Well Capacity (def), 76
- Grab Command, 49, 50, 63
- graphics, 50
- guiding, 44
- guiding error, 52, 67
- hand controller, 49, 52, 55, 56
- hermetic chamber, 40
- Histogram (def), 76
- host computer, 40, 47, 55
- hot pixels, 50
- IBM PC, 40
- image processing, 40, 44, 50, 70
- interference, ii
- IR blocking filter, 53
- joystick, 57
- joystick modification, 58
- library of dark frames, 50, 64
- light frame, 42, 47, 49
- light frame (def), 76
- Link, 47
- LPT port, 47, 48, 55
- magnitude
  - diffuse, 50
  - stellar, 50
- maintenance, 81, 82
- microcontroller, 40
- modifying hand controller, 56
- moon, 48, 63
- negative image, 50
- nosepiece, 47
- observatory, 55
- optical head, 47, 55
- O-ring, 40
- PC, 40
- PC Setup Command, 48
- PEC drive correctors, 51, 67
- photometric measurements, 76
- Photometry (def), 76
- pixel nonuniformity, 50
- pixel size, 42, 60
- Pixel Size (def), 76
- pixel uniformity, 42
- planet mode, 51
- Planet mode (def), 76
- planets, 37, 48, 63
- POWER connector, 47
- power supply, 40, 47
- power supplyr, 55
- PPEC drive correctors, 51, 67
- preamp, 40, 55
- printing images, 45
- push to make switch modification, 57
- push to make/break switch modification, 57
- Quantum Efficiency (def), 76
- range parameter, 50
- readout
  - electronics, 55
  - noise, 60
  - Noise (def), 76
  - register, 38
- regenerating desiccant, 81
- RELAYS connector, 55, 67
- resolution, 42, 51, 64
- Resolution (def), 76
- Response factor (def), 77
- Right Ascension, 55, 67, 74
- Saturation (def), 77
- scribing the eyepiece, 49
- seeing, 42, 49, 51
- Seeing (def), 77
- self guiding, 55
- separations, 50
- setup, 47
- sharpen, 50
- shutter, 40
- signal to noise ratio, 53, 60
- sky background, 37, 51
- smoothing, 50
- snapshot, 55

## Index

software, 58, 70  
spectral range, 37  
Status Window, 47  
    Link field, 47  
stellar magnitude, 50  
stellar temperature, 50  
super pixel, 51  
taking images, 49  
TE cooler, 40  
TE Cooler, 40  
TE Cooler (def), 77  
Technical Support, 71  
telescope, 43, 47, 49, 51  
Telescope connector, 79  
telescope hand controller, 49, 52, 55, 56  
temperature regulation, 50, 59  
thermistor, 41  
TIC, 80  
TIC-78, 56  
TIFF format (def), 77  
Track and Accumulate (def), 77  
Track and Accumulate Command, 51, 63, 67  
Track and Accumulate mode, 55, 65  
Track Command, 67  
track list, 66  
Track List (def), 77  
track mode, 55  
tracking interface cable (TIC), 56, 80  
Tracking Parameters Command, 67  
Tri-Color (def), 77  
tri-color images, 69  
vane, 59  
vignetting, 42, 50  
Vignetting (def), 77  
zoom, 50