

SUPERIOR QUALITY  
**IMAGING OPTICS**  
FOR ANY APPLICATION





## Table of Contents

Capabilities. . . . .	3
Lens-Sensor Integration. . . . .	4
<b>Imaging Lenses</b>	
Resolv4K. . . . .	.6
SingleShot. . . . .	.14
Zoom 6000. . . . .	.16
Optotune Module. . . . .	.22
12X Zoom. . . . .	.24
12X Telecentric. . . . .	.26
DIC Module. . . . .	.32
Zoom Accessories/Combinations. . . . .	.34
Motorized Systems Options. . . . .	.36
Precise Eye Fixed. . . . .	.38
NUV-VIS Zoom. . . . .	.44
Dual View System. . . . .	.46
Modular Tube Lenses. . . . .	.48
HR Plan Apo Microscope Objectives. . . . .	.50
4K HDR Wide Angle. . . . .	.51
Illumination. . . . .	.52
Large Format. . . . .	.54
Low Mag Video/Factory Automation. . . . .	.56
SWIR. . . . .	.64
Video Lens Accessories. . . . .	.65
<b>Cameras</b>	
10 GigE and USB3. . . . .	.64
Autofocus and Microscopy. . . . .	.66
Pixelink Capture and SDK. . . . .	.68
Quick Reference Guide. . . . .	70



**SPECIAL OPTICS®**  
A NAVITAR COMPANY

**Pixelink®**  
A NAVITAR COMPANY



**The Navitar Companies**  
Providing Integrated Imaging Systems for Every Application

**Special Optics**  
Denville, New Jersey  
specialoptics.com

**Navitar**  
Rochester, New York  
navitar.com

**Pixelink**  
Ottawa ON Canada  
pixelink.com

## Capabilities

### Optomechanical Design

- Structural Design
- Materials Selection
- Athermalization/Ruggedization
- Lens Mounting & Positioning
- Precision Centration
- Zoom/Focus Mechanisms
- Custom System Interfaces
- Accurate Assembly/Alignment

### Optical Design

- Design for Manufacturability
- Lens Optimization
- Performance Modeling
- Image Simulation
- Finite Element Analysis
- Illumination Analysis
- Stray Light Analysis

### Custom Industrial Design

- Semiconductor Front-End Equipment
- Semiconductor Back-End Equipment
- Electronic Inspection Equipment
- Factory Automation Systems
- Laser Processing Equipment
- Contamination Analysis Systems
- Atomic Force Microscopy (AFM)

### Fabrication and Polishing

- Glass & Crystal Polishing
- Precision Grinding & Optics Polishing from 4 - 280 mm in Diameter
- Over 1000 Test Plates on Hand
- Surface Regularity Better than 1/20 Wave, 10-5 Surface Quality
- Standard Radii from 2 to 13,931 mm

### System Engineering

- Feasibility/Risk Reduction Analysis
- Specification Development
- Cost Budget Analysis
- Optical & Mechanical Tolerancing
- System Performance Verification
- Lens-Sensor Integration/Alignment
- Integrated System Testing
- HDR Lens Modules

### Assembly

- Air-Space Tolerances Held to 1 Micron
- Continuous Lens Design Reoptimization
- Centration, Wedge, Tilt Tolerances Held to Better than 1 Micron
- Air-Bearing Assembly and Alignment

### Testing

- Interferometers @ 405, 532, 632 and 1064 nm
- Radius Measurement to Within 1 Micron Sagittal Height
- Centration to Within 1 Arc Second
- Flatness and Regularity to Within 1/20 Wave
- Transmission and Reflection Wavefront Error

### Lens and Sensor Active Alignment

- Pitch and Roll Accuracy Within 2 arcmin
- Yaw Accuracy Within 260 arcsec
- Centration accuracy Within 2  $\mu\text{m}$
- Production volume of 120 units per hour



## *Active Alignment of*

Actively aligning a lens to a sensor will provide superior performance and greater consistency, compared to those that are passively aligned.

### **Lens-Sensor Integration**

Active alignment of a lens and sensor enables accurate, cost-effective production of high resolution, precision camera modules. The alignment process ensures the full capability of the lens and sensor are carried over to the completed module.

Smaller pixels and larger sensors are driving the need for fast, high resolution lenses. Meeting these high quality demands, yet maintaining a manufacturable lens at a reasonable cost, has forced engineers to employ a variety of techniques to deal with tolerance concerns during lens design. Many times, these manufacturing techniques result in positional accuracies in the single-digit  $\mu\text{m}$  range.

Often times, manually attaching a high quality lens to a high quality camera results in a poor to mediocre image due to standard, mechanical attachments such as c-mount or f-mount. The tolerances used for the manufacture of standard mounts, though acceptable for standard imaging, are far too lenient for high resolution applications.

### **Active Alignment Process**

At Navitar we utilize state-of-the-art cam test equipment to actively align lenses to sensors for performance critical applications. When our technicians actively align a lens to a sensor, the alignment is based on the actual image captured by the sensor and adjustments are made with unbelievable accuracy.



# Lens & Sensor *Maximum Performance*

Our process will evaluate the image that is generated by the sensor, determine if any dead pixels exist and make adjustments with 6 degrees of freedom. This level of accuracy would not be possible by relying on the machine tolerances of each of the components.

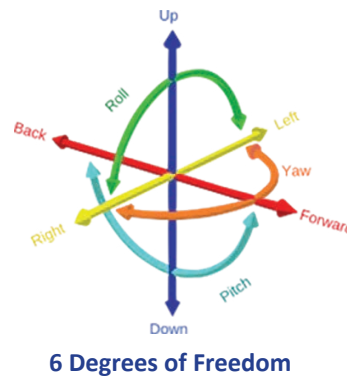

Measures of Accuracy	
Alignment DOF (Degrees of Freedom):	6
Alignment DOF Resolution:	< 0.1 $\mu\text{m}$
Pitch & Roll Accuracy:	< 2 arcmin
Yaw Accuracy:	< 360arcsec
Mechanical Lens to Sensor Centration:	< 2 $\mu\text{m}$
Modules Per Hour:	120

## Benefits of Active Sensor Alignment

This is where active alignment comes into the picture. The lens and sensor are aligned while projecting multiple targets through the lens and onto the sensor while the sensor is imaging. The active alignment machine continually monitors the MTF at each of the target images until all MTF values are within acceptable limits.

When all MTF values are acceptable, preapplied adhesive is partially cured using UV, with complete thermal cure performed later. This allows the sensor to be aligned, within micrometers, to the appropriate lens image plane.

## Precision Camera Module Production

Navitar 4K HDR lenses offer simple operation, little-to-no focus loss over large temperature ranges, outstanding color correction, and low lens-to-lens variation.

Combining HDR lenses with Pixelink camera sensors allows simple image acquisition (via USB 3.0, GigE, Firewire, etc.) and flexible image processing options to suit your individual application.

Choose from off-the-shelf Navitar 4K HDR lenses and Pixelink camera boards from 2/3" up to 1.1" sensor formats or tailor one of our existing designs to fit your specifications with no time lost during the design process. Navitar camera modules are used in the automotive, virtual reality, augmented reality, drone, surveillance and agricultural industries.



# RESOLV4K

LENS SERIES

## Greater Throughput

The Resolv4K Lens Series was designed from first order principles to maximize the usage of a sensors with higher pixel densities. Numerous adapter options allow users to employ a range of sensors from 1/2" through APS formats and beyond. On the front end of the zoom lens attachments give users the best of both worlds; the low mag end of zoom gives wide fields of view with no sacrifice in MTF or loss of illumination, while the high mag end delivers microscope objective like resolution at extremely long working distances.

The Resolv4K lens has been designed not only for superior visible wavelength axial color correction, but dramatically increased wavelength focusing ability with Visible through Near Infrared (Vis-NIR) and SWIR options. Larger aperture lens attachments significantly increase the usable FOV for coaxial lighting options.

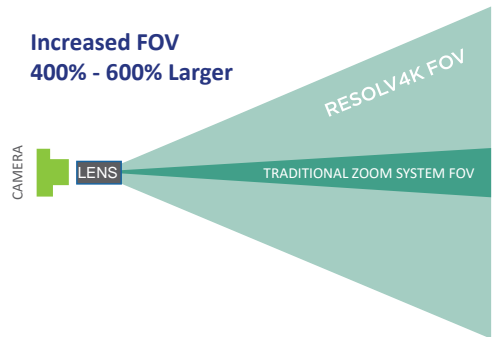

### More Throughput

Combining Resolv4K's large field of view and exceptional lens resolution with modern high pixel density sensors results in faster image capture of a greater area; making it ideal for high speed inspection and precision measurement applications.

### Expanded Wavelengths

The Resolv4K lens series comes in visible, Vis-NIR and SWIR coating options. The visible options produce superior axial color correction to existing zoom lenses. The Vis-NIR option allows precision surface inspection in the deep blue, while performing sub-surface inspection at 1100nm without refocusing or loss of transmission. Using the SWIR goes even further beneath the surface to see damage and defects in food and silicon wafer inspection, among other applications. SWIR and Vis-NIR options are available for the following part numbers:

Transmission of Resolv4K Coating Options

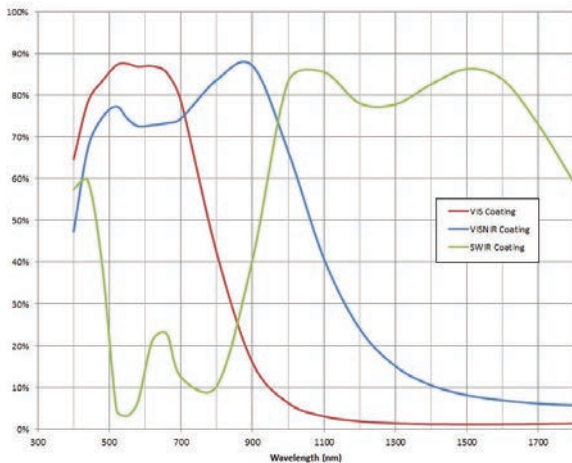

Adapters	Core Zooms & Fixed	Coax	Lens Attachments
1-81101	1-80100	1-81301	1-81201
1-81102	1-80200	1-81303	1-81202
1-81103	1-80300		1-81203
1-81104	1-80500		1-81204
	1-80800		1-81205
			1-81206
			1-81207



# & Larger Field of View

## Greater Resolution

Resolv4K's higher NA, along with its superior aberration correction, gives more precise measurement capabilities than ever. Even comparing a 4.5X zoom point to a 7X mag system, the exceptional quality of the Resolv4K design delivers superior performance, as shown in the black to white transitions in the edge spread functions below. System performance holds up all the way to the corner of the sensor, so multiple regions of interest can be set regardless of their location in your FOV. Your edge detection software will notice the difference.

### 12X Zoom

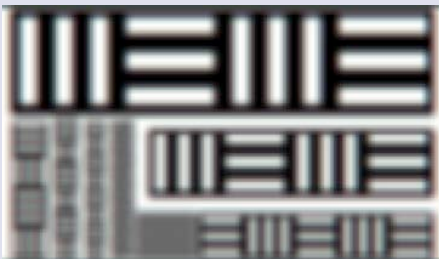

12X Zoom @ 7X High Mag  
2MP Sensor - 0.79 $\mu$ m / pixel  
1.55mm FOV - 1.28 mm<sup>2</sup> Area

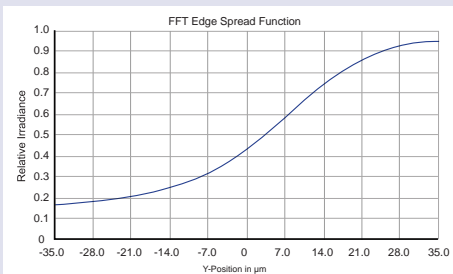
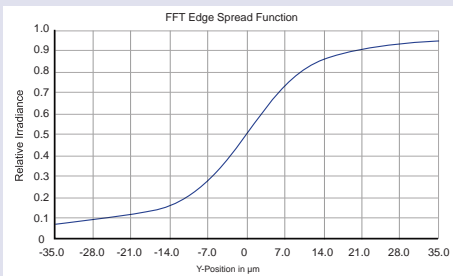

### Navitar Resolv4K Zoom



Resolv4K Zoom @ 4.5X High Mag  
8.9MP Sensor - 0.76 $\mu$ m / pixel  
3.56mm FOV - 5.20 mm<sup>2</sup> Area (3.25X more)

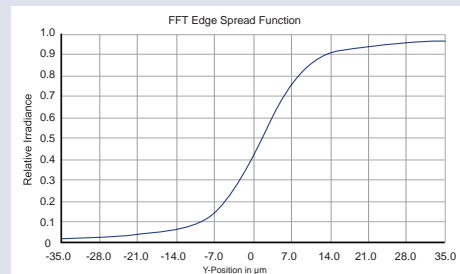
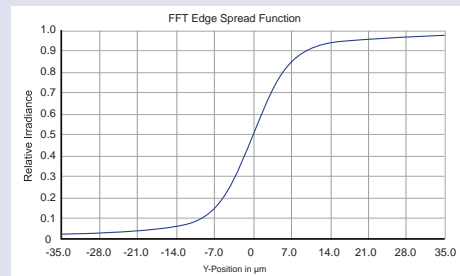

**Top Pictures:** Zoomed in inset of resolution lines, 0.5 $\mu$ m, 1 $\mu$ m, 2 $\mu$ m, 3 $\mu$ m, 4 $\mu$ m, 6 $\mu$ m, 9 $\mu$ m patterns  
**Middle Graphs:** Edge spread function, on axis      **Bottom Graphs:** Edge spread function, corner of the sensor

## Resolv4K Zoom Field of View Matrix

Lens Attachment	Rear Adapter Mag Ideal Camera Format Pixel Resolution		0.6875X 2/3"	1X 1"	1.375X 4/3"	2X 32mm (APS)	Resolve Limit ( $\mu$ m)	Depth of Field (mm)
	W.D. (mm)	Format	2.24 - 5.47 Low-High	3.26 - 7.95 Low-High	4.48 - 10.93 Low-High	6.51 - 15.90 Low-High		
<b>0.25X</b> 0.008 - 0.024 NA <b>1-81201</b>	359.5	Mag.	0.10X - 0.77X	0.16X - 1.13X	0.22X - 1.55X	0.32X - 2.25X	40.85 - 14.13	7.41 - 0.89
		2/3" Sensor	100.00 - 14.22	68.75 - 9.78	50.00 - 7.11	34.38 - 5.17		
		1" Sensor	-	100.00 - 14.22	72.73 - 10.34	50.00 - 7.11		
		1.1" Sensor	-	110.00 - 15.64	80.00 - 11.38	55.00 - 7.82		
		4/3" Sensor	-	-	100.00 - 14.22	68.75 - 9.78		
		32mm	-	-	-	100.00 - 14.22		
<b>0.5X</b> 0.016 - 0.048 NA <b>1-81202</b>	173	Mag.	0.22X - 1.55X	0.32X - 2.25X	0.44X - 3.09X	0.64X - 4.50X	20.43 - 7.06	1.85 - 0.22
		2/3" Sensor	50.00 - 7.11	34.38 - 4.89	25.00 - 3.56	17.19 - 2.44		
		1" Sensor	-	50.00 - 7.11	36.36 - 5.17	25.00 - 3.56		
		1.1" Sensor	-	55.00 - 7.82	40.00 - 5.69	27.50 - 3.91		
		4/3" Sensor	-	-	50.00 - 7.11	34.38 - 4.89		
		32mm	-	-	-	50.00 - 7.11		
<b>0.75X</b> 0.025 - 0.071 NA <b>1-81203</b>	110	Mag.	0.33X - 2.32X	0.48X - 3.38X	0.66X - 4.64X	0.96X - 6.75X	13.62 - 4.71	0.82 - 0.10
		2/3" Sensor	33.33 - 4.74	22.92 - 3.26	16.67 - 2.37	11.46 - 1.63		
		1" Sensor	-	33.33 - 4.74	24.24 - 3.45	16.67 - 2.37		
		1.1" Sensor	-	36.67 - 5.21	26.67 - 3.79	18.33 - 2.61		
		4/3" Sensor	-	-	33.33 - 4.74	22.94 - 3.26		
		32mm	-	-	-	33.33 - 4.74		
<b>1.0X</b> 0.033 - 0.095 NA <b>1-81204</b>	90	Mag.	0.44X - 3.09X	0.64X - 4.50X	0.88X - 6.19X	1.28X - 9.00X	10.21 - 3.53	0.46 - 0.055
		2/3" Sensor	25.00 - 3.56	17.19 - 2.44	12.50 - 1.78	8.59 - 1.22		
		1" Sensor	-	25.00 - 3.56	18.18 - 2.59	12.50 - 1.78		
		1.1" Sensor	-	27.50 - 3.91	20.00 - 2.84	13.75 - 1.96		
		4/3" Sensor	-	-	25.00 - 3.56	17.19 - 2.44		
		32mm	-	-	-	25.00 - 3.56		
<b>1.25X</b> 0.041 - 0.119 NA <b>1-81205</b>	72	Mag.	0.55X - 3.87X	0.80X - 5.63X	1.10X - 7.73X	1.60X - 11.25X	8.17 - 2.83	0.30 - 0.035
		2/3" Sensor	20.00 - 2.84	13.75 - 1.96	10.00 - 1.42	6.88 - 0.98		
		1" Sensor	-	20.00 - 2.84	14.55 - 2.07	10.00 - 1.42		
		1.1" Sensor	-	22.00 - 3.13	16.00 - 2.28	11.00 - 1.56		
		4/3" Sensor	-	-	20.00 - 2.84	13.75 - 1.96		
		32mm	-	-	-	20.00 - 2.84		
<b>1.5X</b> 0.049 - 0.142 NA <b>1-81206</b>	46.5	Mag.	0.66X - 4.64X	0.96X - 6.75X	1.32X - 9.28X	1.92X - 13.50X	6.81 - 2.35	0.206 - 0.025
		2/3" Sensor	16.67 - 2.37	11.46 - 1.63	8.33 - 1.19	5.73 - 0.81		
		1" Sensor	-	16.67 - 2.37	12.12 - 1.72	8.33 - 1.19		
		1.1" Sensor	-	18.33 - 2.61	13.33 - 1.90	9.17 - 1.30		
		4/3" Sensor	-	-	16.67 - 2.37	11.46 - 1.63		
		32mm	-	-	-	16.67 - 2.37		
<b>2.0X</b> 0.066 - 0.190 NA <b>1-81207</b>	32.3	Mag.	0.88X - 6.19X	1.28X - 9.00X	1.76X - 12.38X	2.56X - 18.00X	5.11 - 1.77	0.116 - 0.014
		2/3" Sensor	12.50 - 1.78	8.59 - 1.22	6.25 - 0.89	4.30 - 0.61		
		1" Sensor	-	12.50 - 1.78	9.09 - 1.29	6.25 - 0.89		
		1.1" Sensor	-	13.75 - 1.96	10.00 - 1.42	6.88 - 0.98		
		4/3" Sensor	-	-	12.50 - 1.78	8.59 - 1.22		
		32mm	-	-	-	12.50 - 1.78		

NOTE: Coax and fine focus options all maintain same FOV, resolution, and working distance, subject to adequate lighting

The above fields of view are measured diagonally in millimeters (Horizontal = Diagonal x 0.8 and Vertical = Diagonal x 0.6) on a 4:3 aspect ratio sensor. Dark Gray box: Contact your Navitar sales representative for further guidance when selecting this option.

Resolv4K Field of View Matrix with HR Objectives (mm)

Objective Lens	Rear Adapter Mag		0.6875X	1X	1.375X	2X	Resolve Limit (µm)	Depth of Field (mm)
	Ideal Camera Format		2/3"	1"	4/3"	32mm (APS)		
	Pixel Resolution		2.24 - 5.47	3.26 - 7.95	4.48 - 10.93	6.51 - 15.90		
	W.D. (mm)	Format	Low-High	Low-High	Low-High	Low-High		
<b>Navitar 4X</b> 0.066 - 0.190 NA <b>1-55075</b>	20	Mag.	0.88X- 6.19X	1.28X- 9.00X	1.76X- 12.38X	2.56X- 18.00X	5.11 - 1.77	116 - 14
		2/3" Sensor	8.10- 1.78	8.10- 1.22	6.25- 0.89	4.30- 0.61		
		1" Sensor	-	8.10- 1.78	8.10- 1.29	6.25- 0.89		
		1.1" Sensor	-	8.10- 1.96	8.10- 1.42	6.88- 0.98		
		4/3" Sensor	-	-	8.10- 1.78	8.10- 1.22		
		32mm	-	-	-	8.10- 1.78		
<b>Navitar 6X</b> 0.099 - 0.285 NA <b>1-55401</b>	25	Mag.	1.32X- 9.28X	1.92X- 13.50X	2.64X- 18.56X	3.84X- 27.00X	3.40 - 1.18	51 - 6.2
		2/3" Sensor	6.25- 1.19	6.25- 0.81	4.17- 0.59	2.86- 0.41		
		1" Sensor	-	6.25- 1.19	6.25- 0.86	4.17- 0.59		
		1.1" Sensor	-	6.25- 1.30	6.25- 0.95	4.58- 0.65		
		4/3" Sensor	-	-	6.25- 1.19	6.25- 0.81		
		32mm	-	-	-	6.25- 1.19		
<b>Navitar 10X</b> 0.164 - 0.400 NA <b>1-55227</b>	10	Mag.	2.20X- 15.47X	3.20X- 22.50X	4.40X- 30.94X	6.40X- 45.00X	2.04 - 0.84	19 - 3.1
		2/3" Sensor	3.20- 0.71	3.20- 0.49	2.50- 0.36	1.72- 0.24		
		1" Sensor	-	3.20- 0.71	3.20- 0.52	2.50- 0.36		
		1.1" Sensor	-	3.20- 0.78	3.20- 0.57	2.75- 0.39		
		4/3" Sensor	-	-	3.20- 0.71	3.20- 0.49		
		32mm	-	-	-	3.20- 0.71		
<b>Mitotoyo 5X</b> 0.082 - 0.140 NA <b>1-60226</b>	34	Mag.	1.10X- 7.73X	1.60X- 11.25X	2.20X- 15.47X	3.20X- 22.50X	4.09 - 2.40	74.1 - 25.5
		2/3" Sensor	4.80- 1.42	4.80- 0.98	4.80- 0.71	3.44- 0.49		
		1" Sensor	-	4.80- 1.42	4.80- 1.03	4.80- 0.71		
		1.1" Sensor	-	4.80- 1.56	4.80- 1.14	4.80- 0.78		
		4/3" Sensor	-	-	4.80- 1.42	4.80- 0.98		
		32mm	-	-	-	4.80- 1.42		
<b>Mitotoyo 10X</b> 0.164 - 0.280 NA <b>1-60227</b>	33	Mag.	2.20X- 15.47X	3.20X- 22.50X	4.40X- 30.94X	6.40X- 45.00X	2.04 - 1.20	18.5 - 6.4
		2/3" Sensor	2.40- 0.71	2.40- 0.49	2.40- 0.36	1.72- 0.24		
		1" Sensor	-	2.40- 0.71	2.40- 0.52	2.40- 0.36		
		1.1" Sensor	-	2.40- 0.78	2.40- 0.57	2.40- 0.39		
		4/3" Sensor	-	-	2.40- 0.71	2.40- 0.49		
		32mm	-	-	-	2.40- 0.71		
<b>Mitotoyo 20X</b> 0.329 - 0.420 NA <b>1-60228</b>	20	Mag.	4.40X- 30.94X	6.40X- 45.00X	8.80X- 61.88X	12.80X- 90.00X	1.02 - 0.80	4.6 - 2.8
		2/3" Sensor	1.20- 0.36	1.20- 0.24	1.20- 0.18	0.86- 0.12		
		1" Sensor	-	1.20- 0.36	1.20- 0.26	1.20- 0.18		
		1.1" Sensor	-	1.20- 0.39	1.20- 0.28	1.20- 0.20		
		4/3" Sensor	-	-	1.20- 0.36	1.20- 0.24		
		32mm	-	-	-	1.20- 0.36		

Navitar Objective Lens	Rear Adapter Mag		0.6875X	1X	1.375X	2X	Resolve Limit (µm)	Depth of Field (µm)
	Pixel Resolution		1.85	2.68	3.69	5.37		
	W.D. (mm)	Format						
<b>4X</b> 0.200 NA <b>1-55075</b>	20	Mag.	2.20X	3.20X	4.40X	6.40X	1.77	13.75
		2/3" Sensor	5.00	3.44	2.50	1.72		
		1" Sensor	-	5.00	3.64	2.50		
		1.1" Sensor	-	5.50	4.00	2.75		
		4/3" Sensor	-	-	5.00	3.44		
		APS	-	-	-	5.00		
<b>6X</b> 0.300 NA <b>1-55401</b>	25	Mag.	3.30X	4.80X	6.60X	9.60X	1.12	6.11
		2/3" Sensor	3.33	2.29	1.67	1.15		
		1" Sensor	-	3.33	2.42	1.67		
		1.1" Sensor	-	3.67	2.67	1.83		
		4/3" Sensor	-	-	3.33	2.29		
		APS	-	-	-	3.33		
<b>10X</b> 0.400 NA <b>1-55227</b>	10	Mag.	5.50X	8.00X	11.00X	16.00X	0.70	3.44
		2/3" Sensor	2.00	1.38	1.00	0.69		
		1" Sensor	-	2.00	1.45	1.00		
		1.1" Sensor	-	2.20	1.60	1.10		
		4/3" Sensor	-	-	2.00	1.38		
		APS	-	-	-	2.00		

Dark Gray box: Contact your Navitar sales representative for further guidance when selecting this option.

## Resolv4K Fixed System

The new Resolv4K Fixed system is a combination of the superb optical performance of the Resolv4K Zoom and design principles of our Precise Eye Fixed that is ideal for fixed field of view applications with closer working distances. The Resolv4K Fixed lens offers higher magnification and resolving power than standard enlarging or SLR lenses in macro mode.

- High apertures improve resolving power by 30% at familiar working distances
- Available interface modules allow users to build their system specifically for their needs
- Standard large camera format options
- Compatible with 10MP cameras and beyond
- Built-in rear adapter fine manipulation focus
- Larger focus options with motorization available
- Compatible with Infinity Corrected Objectives

## Resolv4K Fixed Field of View Matrix (in mm at nominal W.D.)

Lens Attachment	Camera Adapter			Format	0.6875X	1X	1.375X	2X
	Pixel Resolution (µm)				1.85	2.68	3.69	5.37
	W.D. (mm)	DOF (mm)	Res. Limit (µm)		Diagonal			
<b>0.25X</b> 0.025 NA <b>1-81201</b>	359.5	0.88	13.42	Mag.	0.275X	0.40X	0.55X	0.80X
				2/3" Sensor	40.00	27.50	20.00	13.75
				1" Sensor	-	40.00	29.09	20.00
				1.1" Sensor	-	44.00	32.00	22.00
				4/3" Sensor	-	-	40.00	27.50
				APS	-	-	-	40.00
<b>0.5X</b> 0.05 NA <b>1-81202</b>	173	0.22	6.71	Mag.	0.55X	0.80X	1.10X	1.60X
				2/3" Sensor	20.00	13.75	10.00	6.88
				1" Sensor	-	20.00	14.55	10.00
				1.1" Sensor	-	22.00	16.00	11.00
				4/3" Sensor	-	-	20.00	13.75
				APS	-	-	-	20.00
<b>0.75X</b> 0.075 NA <b>1-81203</b>	110	0.0978	4.47	Mag.	0.825X	1.20X	1.65X	2.40X
				2/3" Sensor	13.33	9.17	6.67	4.58
				1" Sensor	-	13.33	9.70	6.67
				1.1" Sensor	-	14.67	10.67	7.33
				4/3" Sensor	-	-	13.33	9.17
				APS	-	-	-	13.33
<b>1.0X</b> 0.1 NA <b>1-81204</b>	90	0.055	3.36	Mag.	1.10X	1.60X	2.20X	3.20X
				2/3" Sensor	10.00	6.88	5.00	3.44
				1" Sensor	-	10.00	7.27	5.00
				1.1" Sensor	-	11.00	8.00	5.50
				4/3" Sensor	-	-	10.00	6.88
				APS	-	-	-	10.00
<b>1.25X</b> 0.125 NA <b>1-81205</b>	72	0.0352	2.68	Mag.	1.375X	2.00X	2.750X	4.00X
				2/3" Sensor	8.00	5.50	4.00	2.75
				1" Sensor	-	8.00	5.82	4.00
				1.1" Sensor	-	8.80	6.40	4.40
				4/3" Sensor	-	-	8.00	5.50
				APS	-	-	-	8.00
<b>1.5X</b> 0.15 NA <b>1-81206</b>	46.5	0.0244	2.24	Mag.	1.650X	2.40X	3.30X	4.80X
				2/3" Sensor	6.67	4.58	3.33	2.29
				1" Sensor	-	6.67	4.85	3.33
				1.1" Sensor	-	7.33	5.33	3.67
				4/3" Sensor	-	-	6.67	4.58
				APS	-	-	-	6.67
<b>2X</b> 0.20 NA <b>1-81207</b>	32.3	0.0138	1.68	Mag.	2.20X	3.20X	4.40X	6.40X
				2/3" Sensor	5.00	3.44	2.50	1.72
				1" Sensor	-	5.00	3.64	2.50
				1.1" Sensor	-	5.50	4.00	2.75
				4/3" Sensor	-	-	5.00	3.44
				APS	-	-	-	5.00

Dark Gray box: Contact your Navitar sales representative for further guidance when selecting this option.  
For 4:3 aspect ratio sensor, Horizontal = Diagonal x 0.8, Vertical = Diagonal x 0.6 APS- 32mm image circle

### Greater Field of View

Navitar’s Resolv4K Series offers so much more resolving power, that a 400-600% larger field of view is possible when compared to traditional zoom imaging, without any loss of detail. No need to stitch together multiple images from multiple captures.

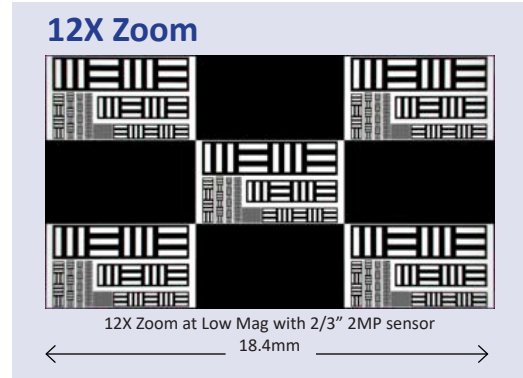

### Navitar Resolv4K Zoom

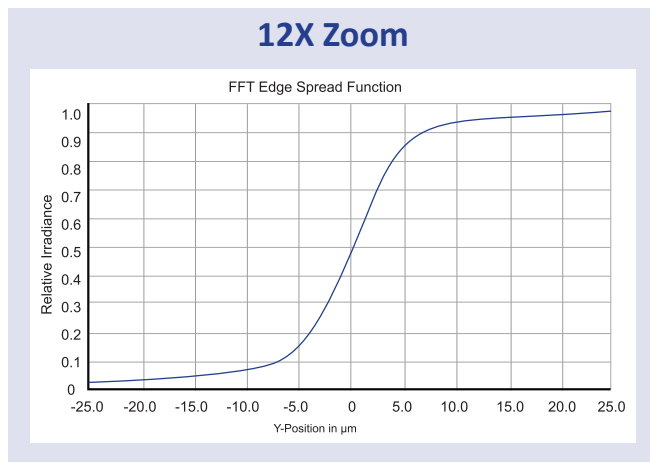
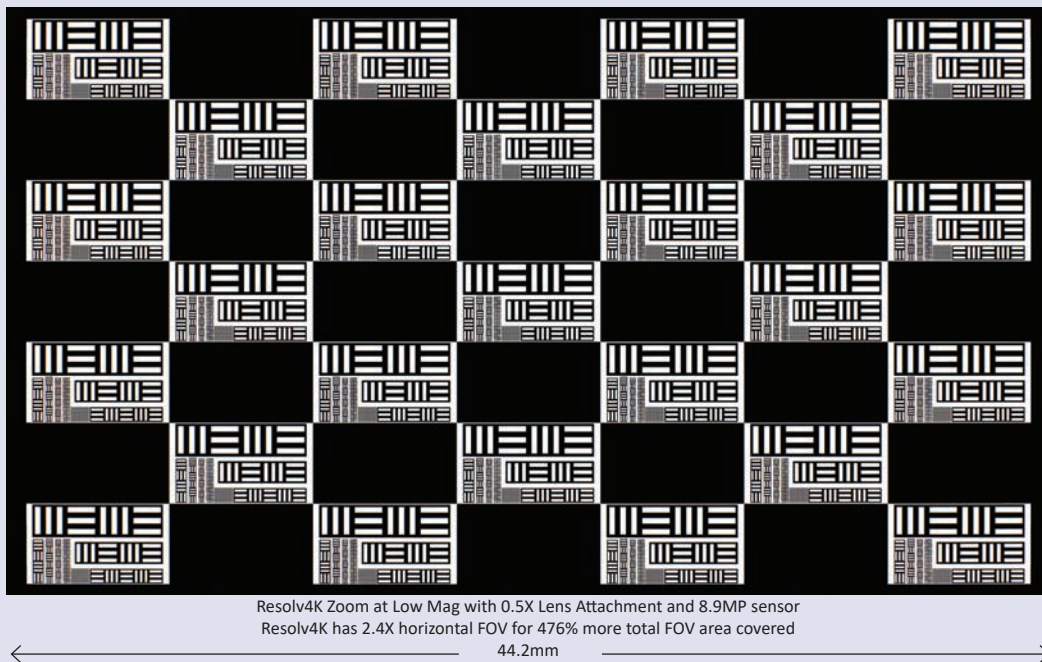

13.6 $\mu\text{m}$  wide transition from full off to full on.

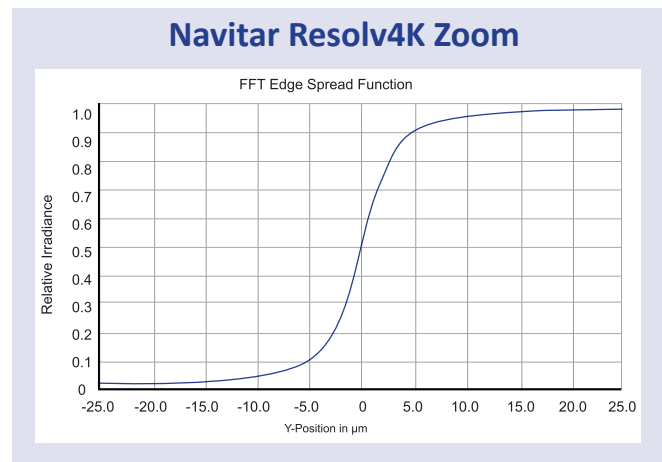

9.6 $\mu\text{m}$  wide transition from full off to full on, a 30% improvement even at a significantly larger FOV and a longer working distance.

Edge spread functions indicate the lens performance of a system by showing how quickly a black to white edge transition is detected by a lens. A 10% to 90% grey level value at the sensor is shown here as indicating a full off to full on.

## Resolv4K Lens System with SWIR and NIR Options

The Resolv4K lens has been designed not only for superior visible wavelength axial color correction, but dramatically increased wavelength focusing ability with visible, Vis-NIR (Visible through Near Infrared) and SWIR options. Larger aperture lens attachments significantly increase the usable FOV for coaxial lighting options.

- Visible option produce superior axial color correction to existing zoom lenses
- Vis-NIR option allows precision surface inspection in the deep blue, while performing sub-surface inspection at 1100nm without refocusing or loss of transmission.
- SWIR option goes even further beneath the surface to see damage and defects, in food and silicon wafer inspection among other applications.

Sample images of bonded wafers showing bond seal rings and alignment marks used in wafer level vacuum packaging. Backlight with halogen using a Navitar Resolv4K system and Acuros™ 1MP SWIR Camera.

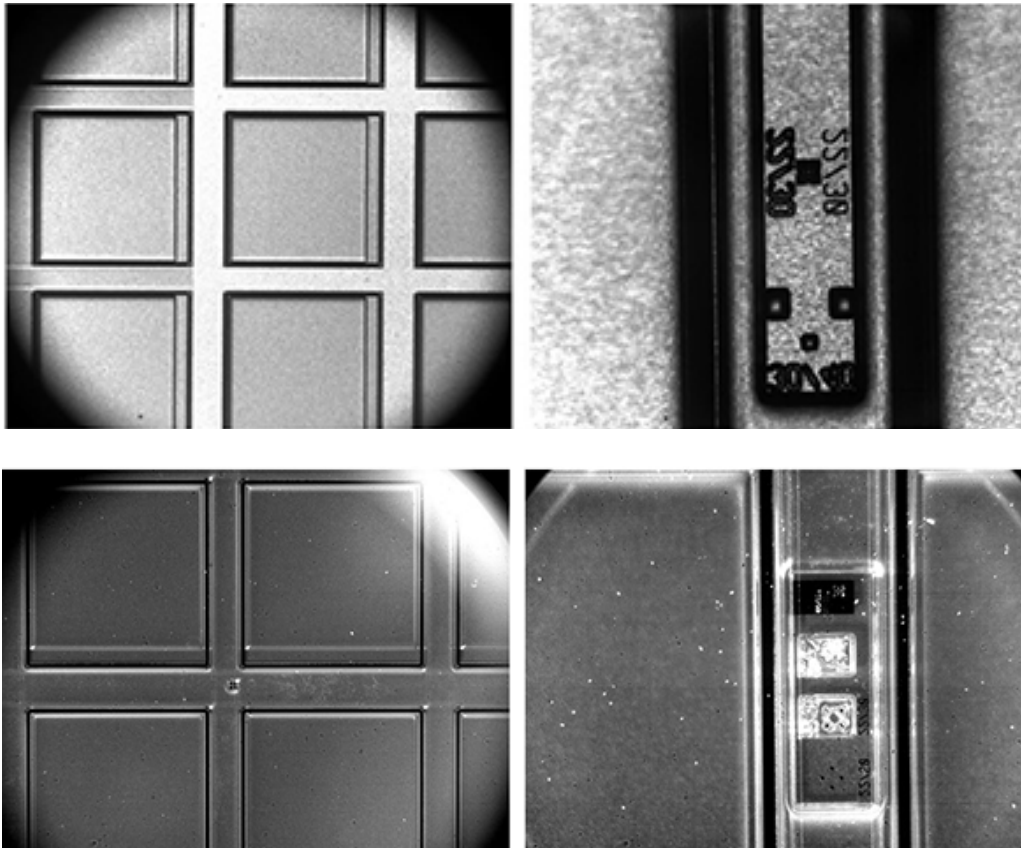

Photos are provided by SWIR Vision Systems.

Cable Length	2 Phase Motor 1-80200	Encoded Motor 1-80300	5 phase motor 1-80500
24"	1-40283	1-40286	1-40290
48"	1-40282	1-40285	1-40289
72"	1-40281	1-40284	1-40170

Available Adapters	
Part #	Description
1-81304	UltraZoom M25x0.75 Adapter
1-81305	UltraZoom M26x36T Adapter Used for all Navitar HR objectives
1-81306	UltraZoom 0.8x36T RMS Adapter

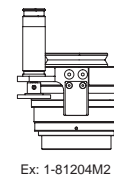

Fine Focus Options on Lens Attachments	
M1	Manual FF
M2	2Φ Motorized FF
M3	Encoded Motor FF
M5	5Φ Motorized FF
e.g. 1-81204M2: 2Φ Motorized 1X LA	

Resolv4K System Diagram

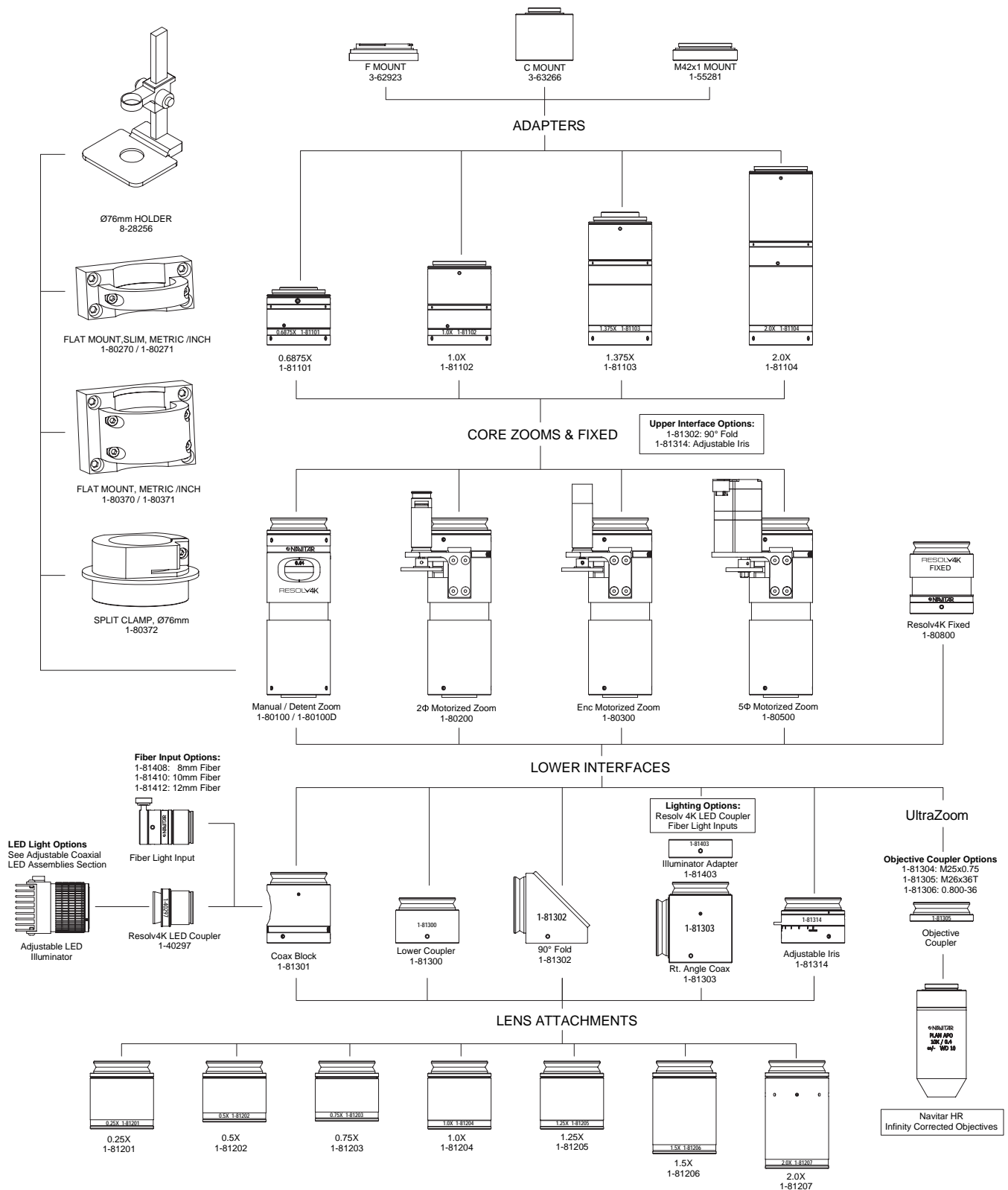

## SingleShot Micro Imaging System

Modular fixed imaging lens system with exceptional performance over a larger field of view

- Use with large format 4/3", 1.1" and 1" sensors
- Digital zoom using Pixelink Capture software
- Compatible with coaxial, ring light or Kohler illumination
- Modular fixed imaging system
- Much larger field of view
- Resolve ~1.24-3.59 microns

### Field of View Matrix

Objective Lens	Working Distance	Depth of Field	Resolution Limit	Tube Lens →	160 mm 1-290070	110 mm 1-290419
				Pixel Resolution →	1.80 μm	1.26 μm
				Sensor Format	Diagonal	Diagonal
<b>160 mm</b> NA: 0.093 <b>1-290070</b>	50 mm	0.057 mm	3.59 μm	<b>MF 1.0</b>	<b>MF 0.71</b>	
				2/3"	10.98	15.48
				1"	15.98	22.52
				1.1"	17.46	24.60
				1.2"	19.27	27.16
4/3"	22.47	31.67				
<b>110 mm</b> NA: 0.133 <b>1-290419</b>	39 mm	0.028 mm	2.53 μm	<b>MF 1.41</b>	<b>MF 1.01</b>	
				2/3"	7.78	10.92
				1"	11.32	15.88
				1.1"	12.36	17.35
				1.2"	13.65	19.16
4/3"	15.91	22.33				
<b>80 mm</b> NA: 0.184 <b>1-290069</b>	25 mm	0.015 mm	1.82 μm	<b>MF 2.01</b>	<b>MF 1.40</b>	
				2/3"	5.47	7.88
				1"	7.96	1.46
				1.1"	8.70	12.52
				1.2"	9.60	13.83
4/3"	11.20	16.12				
<b>53 mm</b> NA: 0.271 <b>1-290418</b>	12 mm	0.007 mm	1.24 μm	<b>MF 3.01</b>	<b>MF 2.09</b>	
				2/3"	3.65	5.26
				1"	5.32	7.65
				1.1"	5.81	8.35
				1.2"	6.41	9.22
4/3"	7.47	10.75				

### Objective Lens Specifications

	Standard Objectives			
	160 mm Tube Lens	110 mm Tube Lens	80 mm Objective	53 mm Objective
Aperture Size	30 mm	30 mm	30 mm	30 mm
EFL	160 mm	110 mm	80 mm	53 mm
F-number	5.33	3.67	2.67	1.67
NA	0.09	0.14	0.19	0.30
Wavelength	445 - 655 nm	445 - 655 nm	445 - 655 nm	445 - 655 nm
Zoom	Digital	Digital	Digital	Digital
Distortion	0.80 %	0.70 %	0.50 %	0.15 %
Working Distance	75 mm	40 mm	25 mm	12.5 mm
Min Feature Size	2.93 μm	2.02 μm	1.47 μm	0.92 μm



SingleShot Lens System with a Pixelink Camera

### Additional Benefits

- Achieve a wider field of view to capture more of the sample with each image - enabling faster object detection and increasing throughput.
- Keep a state of live cell behavior in sight for a longer observation time while reducing cell toxicity and photobleaching.
- Increase throughput by eliminating the need to move optics or the stage and waiting for the software to stitch images together.
- Easily see panoramic images over larger field of view.



## Applications that will benefit from a wider Field of View

### Life Science Applications

- Cell Imaging
- Multi-Well Imaging
- Microfluidic Device Imaging
- Biomedical 3D Measurements
- Fluorescence Microscopy

### Industrial Applications

- Semiconductor Defect Inspection
- Flat Panel Display Inspection
- Industrial Inspection

## SingleShot Micro Imaging System Diagram

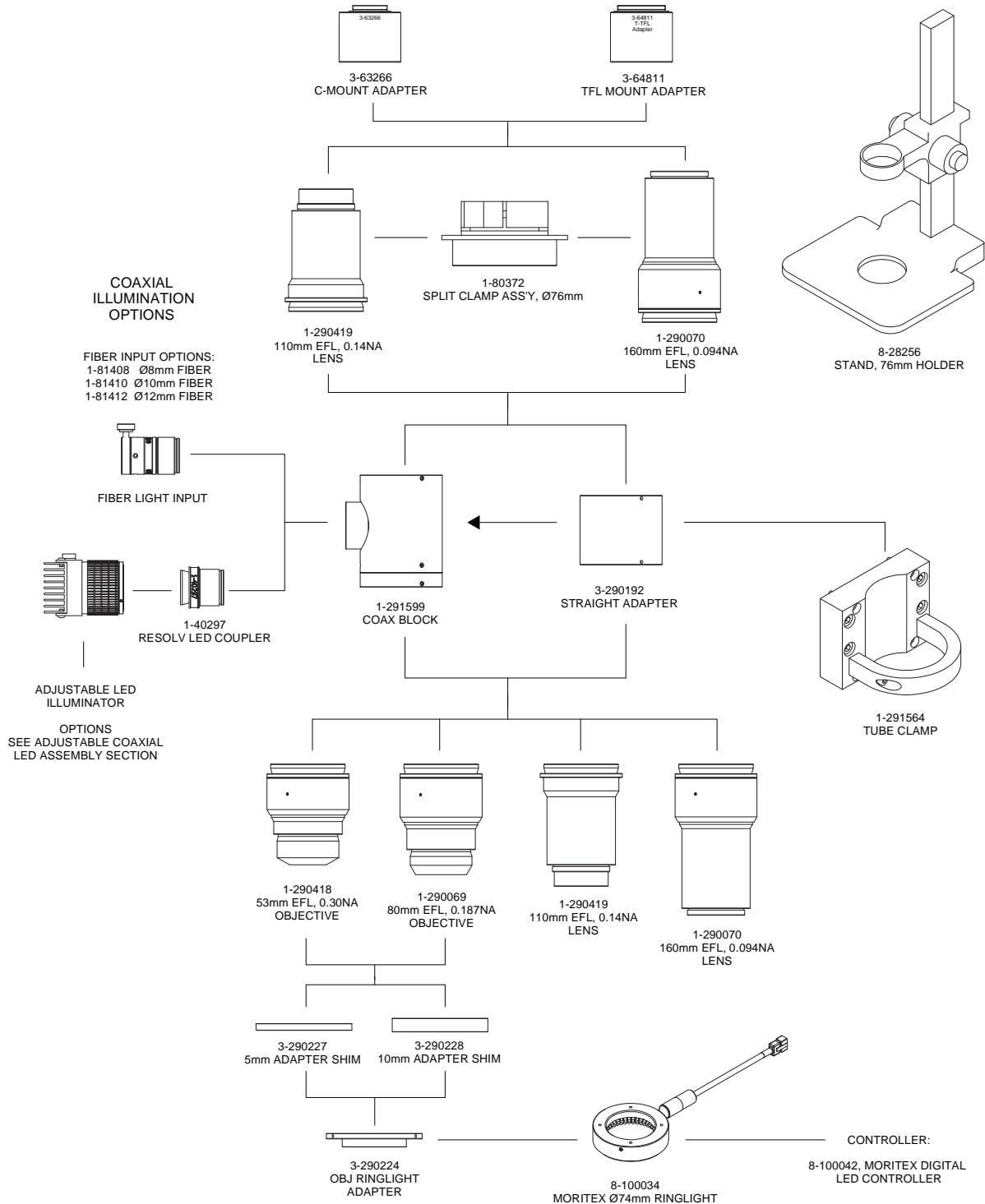

## Zoom 6000 Lens System Unmatched Optical Performance

For high magnification applications, the Zoom 6000 series of lenses is the number one choice around the world. Recognized as the industry standard, our versatile 6.5X zoom lenses are designed to give you the magnification powers of traditional microscopes without the bulk or expense. They are easily integrated, assembled, and configured to your exact application. Compared with the competition, the Navitar Zoom 6000 series offers unmatched optical performance, repeatability and mechanical flexibility.



- Dynamic magnification range of 0.09-393.80X offers incredible versatility
- High contrast images and vivid colors help your equipment perform better
- 0.01-182.72 mm field coverage allows you to view a wide range of parts
- Working distance can be varied from 13 to 390 mm
- Add infinity corrected objective lenses to achieve unmatched edge flatness and clarity
- Body tubes with detents, apertures or motorized are available

### Zoom 6000 Field of View Matrix (in mm at nominal W.D.)

Lens Attachment	Working Distance (mm)	Camera Format/ Parameters	.5X Adapter Low - High	.67X Adapter Low - High	1X Adapter Low - High	1.33X Adapter Low - High	2X Adapter Low - High	3.3X Adapter Low - High	5X Adapter Low - High (2)	Resolve Limit (µm) Low-High	Depth of Field (mm) Low-High
0.25X 0.006- 0.018 NA 1-6044	300 (nominal)  180-334 (1) W.D. range	Mag.	0.09X- 0.56X	0.12X- 0.75X	0.18X- 1.13X	0.24X- 1.50X	0.35X- 2.25X	0.59X- 3.73X	0.88X- 5.62X	55.56- 18.52	13.89- 1.54
		1/3" Sensor	68.64- 10.64	51.12- 8.04	34.32- 5.32	25.80- 4.00	17.16- 2.66	10.40- 1.61	6.88- 1.08	55.56- 18.52	13.89- 1.54
		1/2" Sensor	91.36- 14.16	68.06- 10.66	45.68- 7.08	34.34- 5.32	22.84- 3.54	13.84- 2.14	9.12- 1.44	55.56- 18.52	13.89- 1.54
		2/3" Sensor	91.40- 19.52	93.62- 14.66	62.84- 9.76	47.25- 7.34	31.42- 4.88	19.04- 2.96	12.56- 1.96	55.56- 18.52	13.89- 1.54
		1" Sensor (3)	182.72- 28.32	136.12- 21.32	91.36- 14.16	68.68- 10.64	45.68- 7.08	27.68- 4.28	18.24- 2.88	55.56- 18.52	13.89- 1.54
0.5X 0.011- 0.035 NA 1-60110	175 (nominal)  132-180 (1) W.D. range	Mag.	0.18X- 1.13X	0.24X- 1.50X	0.35X- 2.25X	0.46X- 2.99X	0.70X- 4.50X	1.16X- 7.40X	1.75X- 11.25X	30.30- 9.52	4.13- 0.41
		1/3" Sensor	34.32- 5.32	25.56- 4.00	17.16- 2.67	12.90- 2.01	8.58- 1.33	5.20- 0.81	3.43- 0.53	30.30- 9.52	4.13- 0.41
		1/2" Sensor	45.68- 7.08	34.03- 5.33	22.85- 3.56	17.18- 2.68	11.42- 1.77	6.92- 1.08	4.57- 0.71	30.30- 9.52	4.13- 0.41
		2/3" Sensor(3)	45.70- 9.76	46.81- 7.33	31.43- 4.89	23.63- 3.68	15.71- 2.44	9.52- 1.48	6.29- 0.98	30.30- 9.52	4.13- 0.41
		-	-	68.06- 10.66	45.70- 7.12	34.36- 5.36	22.84- 3.54	13.84- 2.16	9.14- 1.42	30.30- 9.52	4.13- 0.41
0.75X 0.017- 0.053 NA 1-60111	113 (nominal)  95-116 (1) W.D. range	Mag.	0.27X- 1.69X	0.35X- 2.25X	0.53X- 3.38X	0.70X- 4.49X	1.05X- 6.75X	1.75X- 11.15X	2.63X- 16.88X	19.60- 6.28	1.73-0.18
		1/3" Sensor	22.86- 3.56	17.04- 2.67	11.43- 1.78	8.59- 1.34	5.72- 0.89	3.46- 0.54	2.29- 0.35	19.60- 6.28	1.73-0.18
		1/2" Sensor	30.46- 4.74	22.69- 3.56	15.23- 2.37	11.45- 1.78	7.62- 1.19	4.62- 0.72	3.05- 0.47	19.60- 6.28	1.73-0.18
		2/3" Sensor	30.50- 6.52	31.21- 4.89	20.95- 3.26	15.75- 2.45	10.48- 1.63	6.35- 0.99	4.19- 0.65	19.60- 6.28	1.73-0.18
		1" Sensor (3)	60.92- 9.48	45.38- 7.12	30.46- 4.74	22.90- 3.56	15.24- 2.38	9.24- 1.44	6.10- 0.94	19.60- 6.28	1.73-0.18
None 0.023- 0.071 NA	92 (nominal)  80-92 (1) W.D. range	Mag.	0.35X- 2.25X	0.47X- 3.00X	0.70X- 4.50X	0.93X- 5.89X	1.40X- 9.00X	2.31X- 14.85X	3.50X- 22.50X	14.5- 4.70	0.95- 0.10
		1/3" Sensor	17.16- 2.67	12.77- 2.01	8.58- 1.33	6.45- 1.00	4.29- 0.67	2.60- 0.40	1.72- 0.27	14.5- 4.70	0.95- 0.10
		1/2" Sensor	22.85- 3.56	17.01- 2.67	11.42- 1.77	8.59- 1.33	5.71- 0.89	3.46- 0.54	2.28- 0.36	14.5- 4.70	0.95- 0.10
		2/3" Sensor	22.90- 4.89	23.40- 3.65	15.71- 2.44	11.81- 1.83	7.86- 1.22	4.76- 0.74	3.14- 0.49	14.5- 4.70	0.95- 0.10
		1" Sensor (3)	45.70- 7.12	34.02- 5.34	22.84- 3.54	17.18- 2.66	11.42- 1.78	6.92- 1.08	4.56- 0.72	14.5- 4.70	0.95- 0.10
1.5X 0.034- 0.106 NA 1-60112	51 (nominal)  45-52 (1) W.D. range	Mag.	0.53X- 3.38X	0.71X- 4.50X	1.05X- 6.75X	1.40X- 8.98X	2.10X- 13.50X	3.47X- 22.28X	5.25X- 33.75X	9.80- 3.14	0.43- 0.04
		1/3" Sensor	11.43- 1.78	8.52- 1.33	5.72- 0.89	4.3- 0.67	2.86- 0.44	1.73- 0.27	1.14- 0.18	9.80- 3.14	0.43- 0.04
		1/2" Sensor	15.23- 2.37	11.34- 1.77	7.62- 1.19	5.73- 0.89	3.81- 0.59	2.31- 0.36	1.52- 0.24	9.80- 3.14	0.43- 0.04
		2/3" Sensor	15.00- 3.26	15.60- 2.44	10.48- 1.63	7.88- 1.22	5.24- 0.81	3.18- 0.49	2.10- 0.33	9.80- 3.14	0.43- 0.04
		1" Sensor (3)	30.46- 4.74	22.68- 3.54	15.24- 2.38	11.46- 1.78	7.62- 1.18	4.62- 0.72	3.04- 0.48	9.80- 3.14	0.43- 0.04
2.0X 0.040- 0.142 NA 1-60113	36 (nominal)  34-39 (1) W.D. range	Mag.	0.70X- 4.50X	0.94X- 6.00X	1.40X- 9.00X	1.86X- 11.97X	2.80X- 18.00X	4.62X- 29.70X	7.00X- 45.00X	7.24- 2.34	0.24- 0.02
		1/3" Sensor	8.58- 1.33	6.39- 1.00	4.29- 0.67	3.22- 0.50	2.15- 0.33	1.30- 0.14	0.86- 0.13	7.24- 2.34	0.24- 0.02
		1/2" Sensor	11.42- 1.77	8.51- 1.33	5.71- 0.89	4.29- 0.67	2.86- 0.44	1.73- 0.27	1.14- 0.18	7.24- 2.34	0.24- 0.02
		2/3" Sensor	11.40- 2.44	11.70- 1.83	7.86- 1.22	5.91- 0.92	3.93- 0.61	2.38- 0.37	1.57- 0.24	7.24- 2.34	0.24- 0.02
		1" Sensor (3)	22.84- 3.54	17.02- 2.66	11.42- 1.78	8.58- 1.34	5.72- 0.88	3.46- 0.54	2.24- 0.36	7.24- 2.34	0.24- 0.02

The above fields of view are measured diagonally in millimeters (Horizontal = Diagonal x 0.8 and Vertical = Diagonal x 0.6).

(1) Working distance range when using 12 mm fine focus. Field of view will change with shorter or longer working distances.

(2) When using 5X Adapter image quality is greatly reduced. Contact your Navitar sales representative for detailed specifications.

(3) All systems using a 1" sensor should be discussed with a Navitar applications expert.

NA varies depending on system magnification.

Zoom 6000 Performance Specifications

Zoom 6000 Combinations Lens Attachment + Prime Lens + Adapter	Working Distance (mm)	System Magnification	NA Objective	Resolve Limit (µm)	Matching Pixel Size (µm)	Depth of Field (mm)
		Low-High	Low-High	Low-High	Low-High	Low-High
0.25x + 6.5X Zoom + 0.5x	300	0.09- 0.56	0.006- 0.018	55.56- 18.52	2.50- 5.19	13.89- 1.54
0.25x + 6.5X Zoom + 0.67x	300	0.12- 0.75	0.006- 0.018	55.56- 18.52	3.33- 6.95	13.89- 1.54
0.25x + 6.5X Zoom + 1.0x	300	0.18- 1.13	0.006- 0.018	55.56- 18.52	5.00- 10.46	13.89- 1.54
0.25x + 6.5X Zoom + 1.33x	300	0.23- 1.51	0.006- 0.018	55.56- 18.52	6.65- 13.91	13.89- 1.54
0.25x + 6.5X Zoom + 2.0x	300	0.35- 2.25	0.006- 0.018	55.56- 18.52	9.72- 20.84	13.89- 1.54
0.25x + 6.5X Zoom + 3.3x	300	0.58- 3.71	0.006- 0.018	55.56- 18.52	15.29- 28.93	13.89- 1.54
0.25x + 6.5X Zoom + 5.0x	300	0.88- 5.62	0.006- 0.018	55.56- 18.52	24.45- 52.04	13.89- 1.54
0.5x + 6.5X Zoom + 0.5x	175	0.18- 1.13	0.011- 0.035	30.30- 9.52	2.73- 5.38	4.13- 0.41
0.5x + 6.5X Zoom + 0.67x	175	0.23- 1.50	0.011- 0.035	30.30- 9.52	3.48- 7.14	4.13- 0.41
0.5x + 6.5X Zoom + 1.0x	175	0.35- 2.25	0.011- 0.035	30.30- 9.52	5.30- 10.71	4.13- 0.41
0.5x + 6.5X Zoom + 1.33x	175	0.47- 3.03	0.011- 0.035	30.30- 9.52	7.05- 14.24	4.13- 0.41
0.5x + 6.5X Zoom + 2.0x	175	0.70- 4.50	0.011- 0.035	30.30- 9.52	10.61- 21.42	4.13- 0.41
0.5x + 6.5X Zoom + 3.3x	175	1.16- 7.43	0.011- 0.035	30.30- 9.52	15.44- 39.08	4.13- 0.41
0.5x + 6.5X Zoom + 5.0x	175	1.75- 11.25	0.011- 0.035	30.30- 9.52	26.51- 53.55	4.13- 0.41
0.75x + 6.5X Zoom + 0.5x	113	0.26- 1.69	0.017- 0.053	19.62- 6.28	2.55- 5.32	1.73- 0.18
0.75x + 6.5X Zoom + 0.67x	113	0.35- 2.25	0.017- 0.053	19.62- 6.28	3.43- 7.08	1.73- 0.18
0.75x + 6.5X Zoom + 1.0x	113	0.53- 3.38	0.017- 0.053	19.62- 6.28	5.20- 10.63	1.73- 0.18
0.75x + 6.5X Zoom + 1.33x	113	0.70- 4.54	0.017- 0.053	19.62- 6.28	6.92- 14.13	1.73- 0.18
0.75x + 6.5X Zoom + 2.0x	113	1.05- 6.75	0.017- 0.053	19.62- 6.28	10.30- 21.23	1.73- 0.18
0.75x + 6.5X Zoom + 3.3x	113	1.73- 11.14	0.017- 0.053	19.62- 6.28	15.36- 33.31	1.73- 0.18
0.75x + 6.5X Zoom + 5.0x	113	2.63- 16.88	0.017- 0.053	19.62- 6.28	25.74- 53.09	1.73- 0.18
None + 6.5X Zoom + 0.5x	92	0.35- 2.25	0.023- 0.071	14.50- 4.70	2.54- 5.28	0.95- 0.10
None + 6.5X Zoom + 0.67x	92	0.47- 3.00	0.023- 0.071	14.50- 4.70	3.41- 7.04	0.95- 0.10
None + 6.5X Zoom + 1.0x	92	0.70- 4.50	0.023- 0.071	14.50- 4.70	5.08- 10.55	0.95- 0.10
None + 6.5X Zoom + 1.33x	92	0.93- 6.05	0.023- 0.071	14.50- 4.70	6.76- 14.03	0.95- 0.10
None + 6.5X Zoom + 2.0x	92	1.40- 9.00	0.023- 0.071	14.50- 4.70	10.15- 21.11	0.95- 0.10
None + 6.5X Zoom + 3.3x	92	2.31- 14.85	0.023- 0.071	14.50- 4.70	15.29- 29.11	0.95- 0.10
None + 6.5X Zoom + 5.0x	92	3.50- 22.50	0.023- 0.071	14.50- 4.70	25.38- 52.76	0.95- 0.10
1.5x + 6.5X Zoom + 0.5x	51	0.53- 3.38	0.034- 0.106	9.80- 3.14	2.60- 5.32	0.43- 0.04
1.5x + 6.5X Zoom + 0.67x	51	0.70- 4.50	0.034- 0.106	9.80- 3.14	3.43- 7.09	0.43- 0.04
1.5x + 6.5X Zoom + 1.0x	51	1.05- 6.75	0.034- 0.106	9.80- 3.14	5.15- 10.63	0.43- 0.04
1.5x + 6.5X Zoom + 1.33	51	1.40- 9.08	0.034- 0.106	9.80- 3.14	6.85- 14.14	0.43- 0.04
1.5x + 6.5X Zoom + 2.0x	51	2.10- 13.50	0.034- 0.106	9.80- 3.14	10.29- 21.26	0.43- 0.04
1.5x + 6.5X Zoom + 3.3x	51	3.47- 22.28	0.034- 0.106	9.80- 3.14	15.29- 28.92	0.43- 0.04
1.5x + 6.5X Zoom + 5.0x	51	5.25- 33.75	0.034- 0.106	9.80- 3.14	25.73- 53.16	0.43- 0.04
2.0x + 6.5X Zoom + 0.5x	36	0.70- 4.50	0.046- 0.142	7.24- 2.34	2.54- 5.29	0.24- 0.02
2.0x + 6.5X Zoom + 0.67x	36	0.94- 6.00	0.046- 0.142	7.24- 2.34	3.41- 7.05	0.24- 0.02
2.0x + 6.5X Zoom + 1.0x	36	1.40- 9.00	0.046- 0.142	7.24- 2.34	5.08- 10.58	0.24- 0.02
2.0x + 6.5X Zoom + 1.33	36	1.86- 12.10	0.046- 0.142	7.24- 2.34	6.76- 14.07	0.24- 0.02
2.0x + 6.5X Zoom + 2.0x	36	2.80- 18.00	0.046- 0.142	7.24- 2.34	10.15- 21.15	0.24- 0.02
2.0x + 6.5X Zoom + 3.3x	36	4.62- 29.70	0.046- 0.142	7.24- 2.34	15.30- 28.70	0.24- 0.02
2.0x + 6.5X Zoom + 5.0x	36	7.00- 45.00	0.046- 0.142	7.24- 2.34	25.38- 52.88	0.24- 0.02

Assumptions:

1. Minimum resolvable feature size is half of the threshold line pair limit. Calculation = 1/(3000 x Lens NA)
2. Matching pixel size is that which will permit the minimum feature size to overlap two pixels. Calculation = 1/2(Feature Size x System Magnification)
3. If the matching pixel size is greater than the camera pixel size, the system is "lens limited."
4. If the matching pixel size is less than the camera pixel size, the system is "camera limited."

## Combine Infinity-Corrected Objectives for Maximum Resolution and Magnification

Navitar's Zoom 6000 UltraZoom is ideal for semiconductor inspection, flow cytometry, and other high magnification applications. Its advanced design offers high resolution and outstanding contrast. This system incorporates infinity corrected, plan apochromatic objectives providing long working distances and excellent edge flatness and clarity. Resolution varies from 420 to 1,650 lines per mm, depending on the microscope objective used. The UltraZoom is also available with fine focus and/or coaxial illumination.

### Zoom 6000 UltraZoom Field of View Matrix (for part number's 1-60190, 1-60191, 1-60349 and 1-60350 in mm)

Objective Lens Long W.D	Working Distance (mm)	Camera Format/ Parameters	1X Adapter Low - High	1.33X Adapter Low - High	2X Adapter Low - High	3.3X Adapter Low - High
4X 0.20 NA* 1-55341	20	Mag.	1.99X- 9.14X	1.79X- 12.16X	2.78X- 18.29X	4.59X- 30.18X
		1/4" Sensor	2.01- 0.44	2.24- 0.33	1.44- 0.22	0.87- 0.13
		1/3" Sensor	3.02- 0.66	3.35- 0.49	2.16- 0.33	1.31- 0.20
		1/2" Sensor	(1) 5.15- 0.87	4.47- 0.66	2.87- 0.44	1.74- 0.27
		2/3" Sensor	(1) 5.15- 1.20	6.15- 0.90	3.95- 0.60	2.39- 0.36
5X 0.14 NA* 1-60226	34	Mag.	1.74X- 11.43X	2.30X- 15.00X	3.48X- 22.86X	5.74X- 37.72X
		1/4" Sensor	2.30- 0.35	1.74- 0.26	1.15- 0.17	0.70- 0.11
		1/3" Sensor	3.45- 0.52	2.61- 0.40	1.72- 0.26	1.04- 0.16
		1/2" Sensor	(1) 4.05- 0.70	3.48- 0.54	2.30- 0.35	1.39- 0.21
		2/3" Sensor	(1) 4.02- 0.96	4.00- 0.74	3.16- 0.48	1.92- 0.29
10X 0.28 NA* 1-60227	33	Mag.	3.48X- 22.86X	4.63X- 29.90X	6.96X- 45.72X	11.48X- 75.44X
		1/4" Sensor	1.15- 0.17	0.86- 0.13	0.57- 0.09	0.35- 0.05
		1/3" Sensor	1.72- 0.26	1.30- 0.20	0.86- 0.13	0.52- 0.08
		1/2" Sensor	(1) 2.10- 0.35	1.73- 0.27	1.15- 0.17	0.70- 0.11
		2/3" Sensor	(1) 2.10- 0.48	2.10- 0.37	1.58- 0.24	0.96- 0.15
20X 0.42 NA* 1-60228	20	Mag.	6.96X- 45.72X	9.30X- 59.90X	13.92X- 91.40X	22.97X- 150.88X
		1/4" Sensor	0.57- 0.09	0.43- 0.07	0.29- 0.04	0.17- 0.03
		1/3" Sensor	0.86- 0.13	0.65- 0.10	0.43- 0.07	0.26- 0.04
		1/2" Sensor	(1) 1.00- 0.17	0.86- 0.14	0.57- 0.09	0.35- 0.05
		2/3" Sensor	(1) 1.03- 0.24	1.00- 0.19	0.79- 0.12	0.48- 0.07
50X 0.55 NA* 1-60229	13	Mag.	17.40X- 114.30X	23.00X-150.00X	34.80X- 228.60X	57.42X- 377.19X
		1/4" Sensor	0.23- 0.03	0.17- 0.03	0.11- 0.02	0.07- 0.011
		1/3" Sensor	0.30- 0.05	0.26- 0.04	0.17- 0.03	0.10- 0.020
		1/2" Sensor	(1) 0.31- 0.07	0.30- 0.05	0.23- 0.04	0.14- 0.020
		2/3" Sensor	(1) 0.30- 0.10	(1) 0.30- 0.07	(1) 0.30- 0.05	0.19- 0.030

NOTE: (1) Entire zoom range is not used. \*NA at high mag. NA varies with zoom settings.



## Zoom 6000 with Co-axial Illumination

Navitar’s Zoom 6000 with Internal Co-axial Illumination (1-60123) is an ideal solution for applications involving highly reflective surfaces, such as wafers, polished samples, and fluids. Designed to provide even illumination for higher magnification applications, coaxial illumination provides extremely detailed resolution, particularly when a high resolution camera is used.

### Zoom 6000 with Co-axial Illumination FOV Matrix 1-60123 (mm at nominal W.D.)

Lens Attachment	W.D. (mm)	Camera Format/Parameters	.5X Adapter Low - High	.67X Adapter Low - High	1X Adapter Low - High	1.33X Adapter Low - High	2X Adapter Low - High	3.3X Adapter Low - High	5X Adapter Low - High
None 0.023-0.071 NA	92 (nominal)	Mag.	0.35X- 2.25X	0.47X- 3.00X	0.70X- 4.50X	0.93X- 6.00X	1.40X- 9.00X	2.45X- 15.75X	3.50X- 22.50X
		1/4" Sensor	11.43- 1.78	8.51- 1.33	5.71- 0.89	4.30X- 0.67	2.86- 0.45	1.63- 0.25	1.14- 0.18
	90-93 (1) W.D. range	1/3" Sensor	(2) 11.10- 2.67	(2) 11.40- 2.01	8.58- 1.33	6.45- 1.00	4.29- 0.67	2.45- 0.38	1.72- 0.27
		1/2" Sensor	(2) 11.20- 3.56	(2) 11.46- 2.62	11.42- 1.77	8.60- 1.33	5.71- 0.89	3.27- 0.51	2.28- 0.36
		2/3" Sensor	(2) 11.06- 4.89	(2) 11.54- 3.60	11.40- 2.44	11.00- 1.83	7.86- 1.22	4.49- 0.70	3.14- 0.49
1.5X 0.034-0.106 NA 1-60112	51 (nominal)	Mag.	0.53X- 3.38X	0.71X- 4.50X	1.05X- 6.75X	1.40X-9.00X	2.10X- 13.50X	3.70X- 23.60X	5.25X- 33.75X
		1/4" Sensor	7.62- 1.18	5.67- 0.89	3.81- 0.59	2.85- 0.44	1.91- 0.30	1.08- 0.17	0.76- 0.120
	51-53 (1) W.D. range	1/3" Sensor	11.32- 1.78	8.52- 1.33	5.72- 0.89	4.29- 0.67	2.86- 0.44	1.62- 0.25	1.14- 0.18
		1/2" Sensor	(2) 11.20- 2.37	11.34- 1.77	7.62- 1.19	5.71- 0.89	3.81- 0.59	2.16- 0.34	1.52- 0.24
		2/3" Sensor	(2) 11.20- 3.25	(2) 11.20- 2.44	10.48- 1.63	7.86- 1.22	5.24- 0.81	2.97- 0.47	2.10- 0.33
2.0X 0.046-0.1421 NA 1-60113	36 (nominal)	Mag.	0.70X- 4.50X	0.94X- 6.00X	1.40X- 9.00X	1.86X-12.00X	2.80X - 18.00X	4.90X-31.50X	7.00X - 45.00X
		1/4" Sensor	5.71- 0.89	4.26- 0.67	2.86- 0.45	2.15- 0.33	1.43- 0.23	0.82- 0.13	0.57- 0.09
	36-37 (1) W.D. range	1/3" Sensor	8.57- 1.33	6.39- 1.00	4.29- 0.67	3.22- 0.50	2.15- 0.33	1.22- 0.19	0.86- 0.13
		1/2" Sensor	(2) 11.20- 1.77	8.51- 1.33	5.71- 0.89	4.30- 0.67	2.86- 0.44	1.63- 0.25	1.14- 0.18
		2/3" Sensor	(2) 11.20- 2.44	(2) 11.70- 1.83	7.86- 1.22	5.91- 0.92	3.93- 0.61	2.24- 0.35	1.57- 0.24

**NOTE:**

The internal coax will illuminate a circular area of about 11 mm in diameter. Any field of view larger than 11 mm will have darkened corners.

Low power lens attachments can be used but produce increasing vignetting.

(1) Working distance range when using 3 mm fine focus.

(2) Entire zoom range is not used.

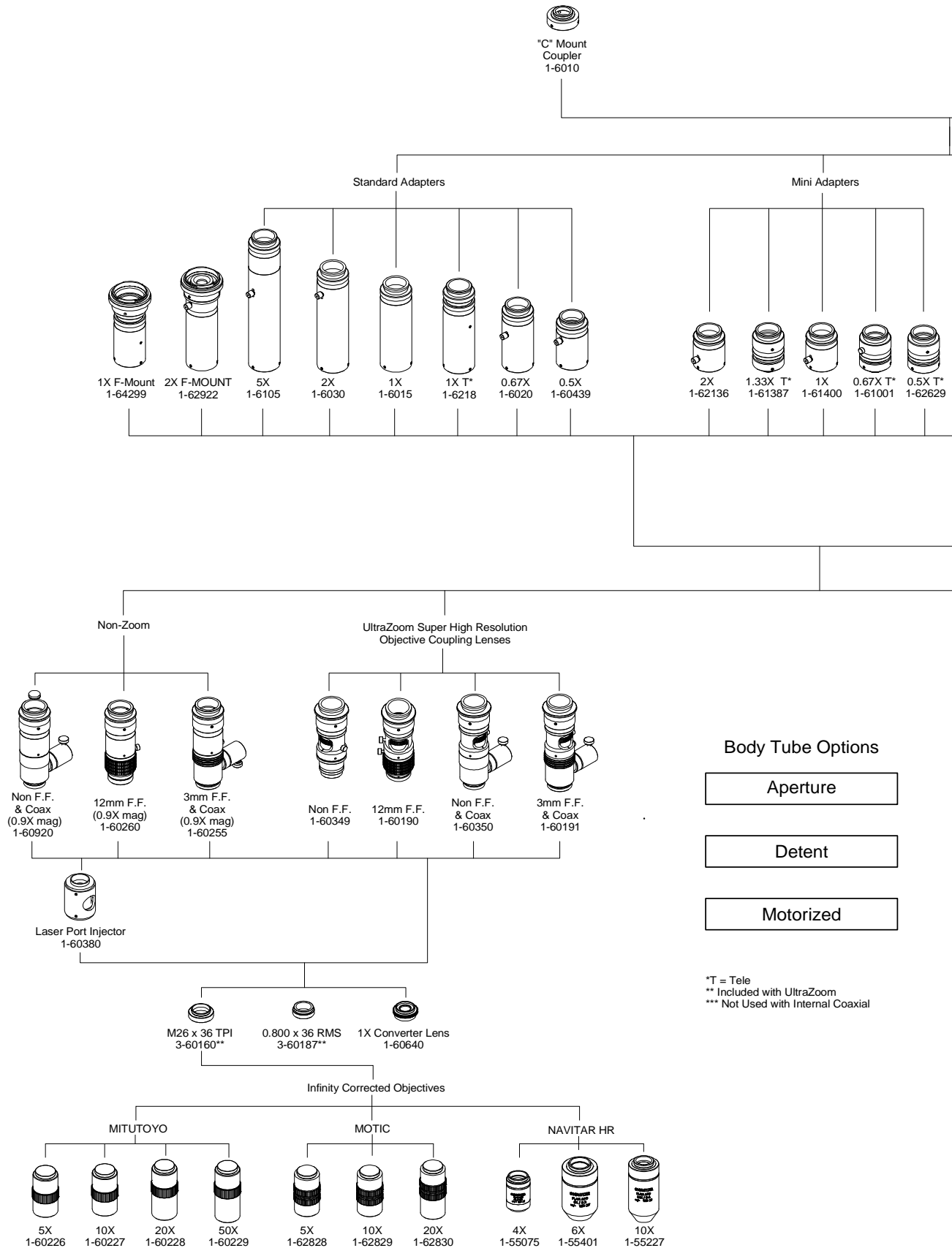

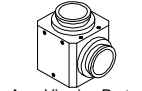
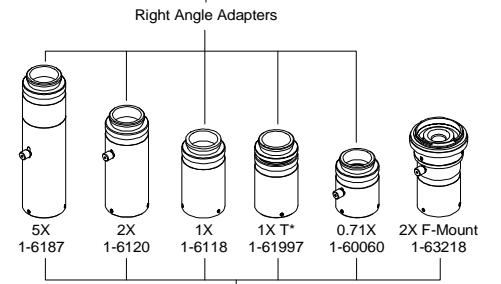
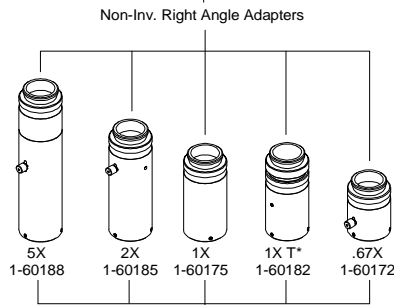
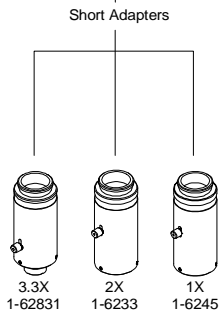
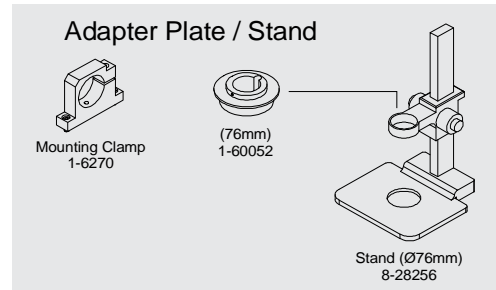
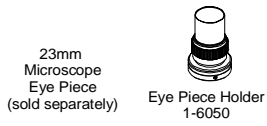

## Zoom Lenses

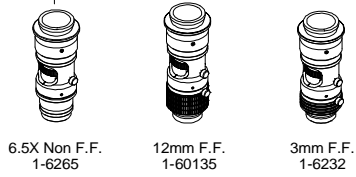

## NIRA Viewers\*\*\*



## Lens Attachments

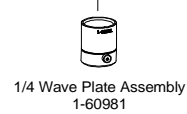
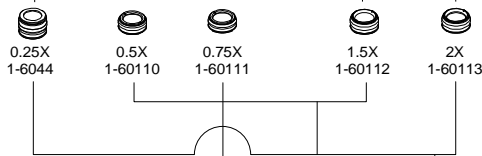

## Zoom 6000 with Optotune

Gain greater working distance and faster focus by integrating a tunable lens focus module with the Navitar Zoom 6000 digital imaging system.

### Key Features

- Fast and accurate fine focus adjustment in a compact design
- Extends working distance range of the 6X lens attachments
- Increases depth of field when coupled with infinity corrected microscope objectives
- Maintains image resolution with the integrated Optotune EL 16-40 tunable lens
- Long cycle life of the tunable lens unit and motorized Zoom 6000 system
- Easy to install USB electrical lens driver with software to control the tunable lens



Optotune Module  
(Navitar 1-64805)  
with Zoom 6000  
Motorized System

## Zoom 6000 with Optotune - Additional Working Distances

Lens Attachment	Optotune Power (Diopters)	Working Distance (mm)	Magnification		Object NA		Resolve Limit (μm)	
			Low Mag	High Mag	Low Mag	High Mag	Low Mag	High Mag
0.25X 1-6044	-2	2260.3	0.026	0.166	0.001	0.003	383.59	146.32
	-1	531.1	0.104	0.673	0.004	0.012	94.91	32.37
	0	288.8	0.183	1.173	0.007	0.021	54.15	20.30
	1	191.3	0.262	1.686	0.009	0.030	37.85	19.26
	2	139.1	0.341	2.202	0.012	0.038	29.06	14.30
	3	106.3	0.421	2.742	0.015	0.047	24.77	11.12
0.5X 1-60110	-2	301.4	0.212	1.348	0.008	0.024	47.14	16.86
	-1	222.9	0.277	1.751	0.010	0.031	36.41	13.60
	0	174.0	0.343	2.168	0.012	0.039	28.84	10.73
	1	140.8	0.409	2.587	0.015	0.046	23.95	10.17
	2	116.8	0.475	3.003	0.017	0.054	20.83	12.33
	3	98.6	0.542	3.441	0.019	0.061	18.46	9.69
0.75X 1-60111	-2	152.8	0.410	2.635	0.015	0.046	24.13	9.26
	-1	128.8	0.470	3.009	0.017	0.053	20.85	7.38
	0	110.1	0.530	3.389	0.019	0.060	18.48	6.42
	1	95.3	0.591	3.760	0.021	0.067	16.76	6.03
	2	83.2	0.651	4.151	0.023	0.073	15.35	8.01
	3	73.1	0.712	4.567	0.026	0.080	14.18	7.81
1.0X None	-2	116.6	0.590	3.803	0.021	0.066	16.63	6.57
	-1	104.4	0.644	4.144	0.023	0.072	15.38	5.36
	0	94.0	0.698	4.503	0.025	0.078	14.19	4.85
	1	85.2	0.752	4.835	0.027	0.085	13.16	4.81
	2	77.5	0.807	5.199	0.029	0.091	12.52	6.01
	3	70.8	0.862	5.590	0.031	0.097	11.96	6.17
1.5X 1-60112	-2	58.1	0.956	6.210	0.034	0.107	10.57	4.24
	-1	53.3	1.004	6.481	0.036	0.112	9.86	3.51
	0	48.9	1.053	6.760	0.038	0.118	9.40	3.22
	1	44.9	1.102	7.047	0.039	0.123	8.90	3.46
	2	41.3	1.151	7.372	0.041	0.129	8.69	4.84
	3	37.9	1.201	7.745	0.043	0.134	8.50	4.30
2X 1-60113	-2	41.1	1.309	8.473	0.047	0.146	7.79	3.28
	-1	38.5	1.347	8.658	0.048	0.150	7.35	2.69
	0	36.0	1.386	8.864	0.050	0.155	7.08	2.45
	1	33.7	1.424	9.084	0.051	0.159	6.95	2.50
	2	31.4	1.463	9.358	0.052	0.163	6.90	3.95
	3	29.3	1.503	9.694	0.054	0.167	7.01	3.82



## Zoom 6000 with Optotune and Navitar Objectives - Additional Working Distances

Lens Attachment	Optotune Power (Diopters)	Working Distance (mm)	Magnification		Object NA		Resolve Limit (μm)		Matching Pixel Size	
			Low Mag	High Mag	Low Mag	High Mag	Low Mag	High Mag	Low Mag	High Mag
4X 1-55075	-2	25	1.24	8.07	0.043	0.126	8.29	2.95	5.15	11.91
	-1	22	1.31	8.48	0.046	0.135	7.81	2.56	5.10	10.87
	0	20	1.37	8.86	0.049	0.145	7.45	2.40	5.10	10.64
	1	17	1.43	9.22	0.053	0.155	7.27	2.52	5.21	11.63
	2	15	1.50	9.58	0.056	0.166	7.19	3.26	5.38	15.63
	3	13	1.56	9.96	0.060	0.177	7.05	3.24	5.49	16.13
6X 1-55401	-2	27	2.11	13.88	0.072	0.213	4.88	1.85	5.15	12.82
	-1	26	2.08	13.53	0.213	0.214	4.91	1.64	5.10	11.11
	0	25	2.05	13.17	0.214	0.217	4.99	1.62	5.10	10.64
	1	24	2.01	12.82	0.217	0.219	5.28	1.90	5.32	12.19
	2	23	1.98	12.50	0.219	0.221	5.61	2.35	5.55	14.71
	3	21	1.95	12.22	0.224	0.224	6.04	2.73	5.88	16.67

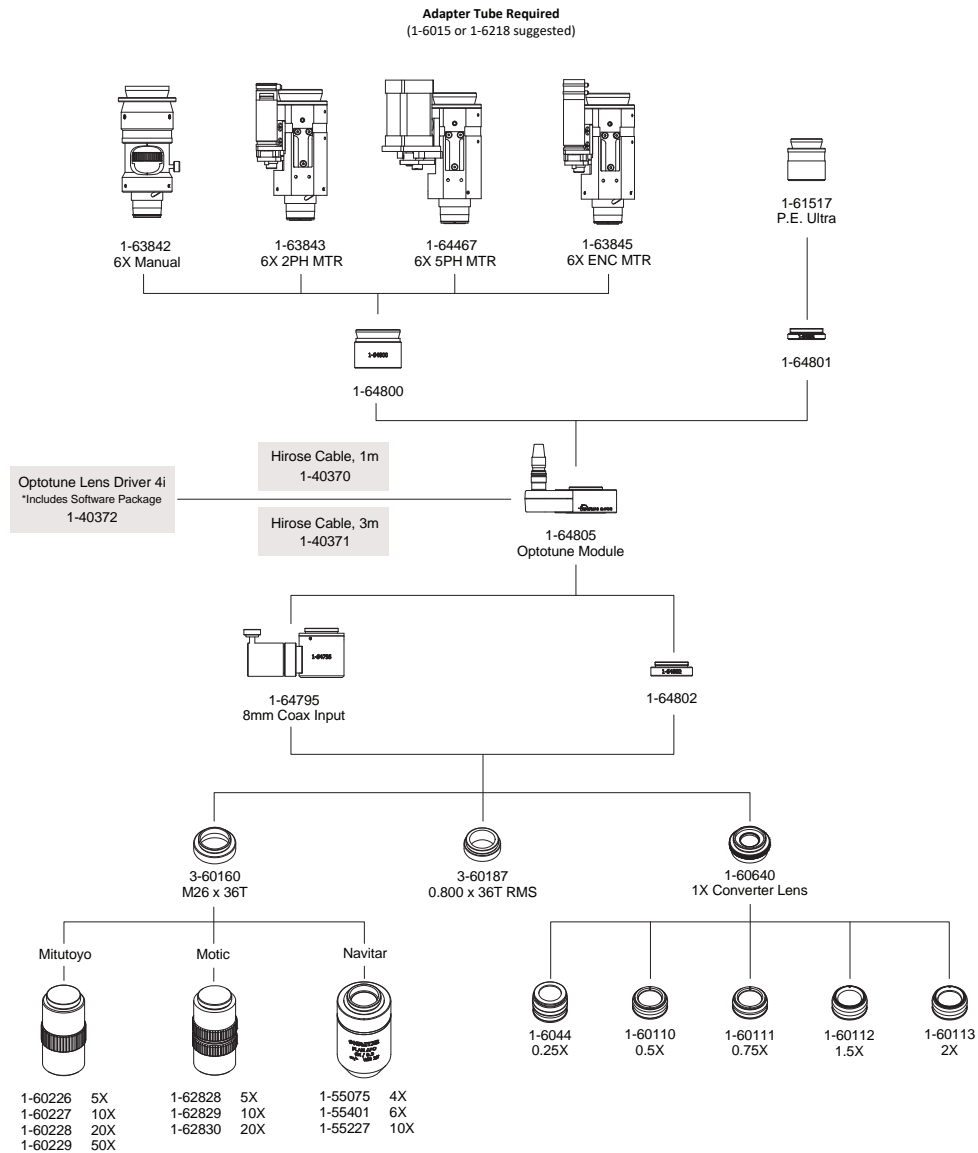

## 12X Zoom Lens System Navitar's Highest Combination of Zoom Range and Resolution

For high magnification applications requiring the optimal balance between optical performance, large zoom range and price, the 12X is an ideal choice. The 12X Zoom incorporates all the mechanical flexibility of the Zoom 6000 with extended zoom range, higher NA and unbeatable accuracy and repeatability for the most demanding applications. This outstanding combination of zoom range, coupled with large field coverage, means that you will now be able to view a wider range of parts with a single video inspection system and eliminate the need for bulky microscopes.



- Incredible 12X (0.58-7X) magnification for inspection of a wider range of parts
- Increased resolution with 0.005 - 0.550 NA
- Variable working distance from 13 to 341 mm
- Field of view from 0.006 mm to 85.71 mm with attachments
- Unmatched edge flatness and clarity
- Works with 1/4", 1/3", 1/2" and 2/3" format cameras
- The 12X Zoom System utilizes existing Zoom 6000 adapter tubes
- Body tubes with detents, apertures or motorized are available

### 12X Zoom Field of View Matrix (in mm)

Lens Attachment	W.D. (mm)	Camera Formats/Parameters	0.5X Adapter Low-High	0.67X Adapter Low-High	1X Adapter Low-High	1.33X Adapter Low-High	2X Adapter Low-High	3.3X Adapter Low-High	Resolve Limit Low-High (μm)	Depth of Field Low-High (mm)
0.25X (2)0.005-0.025 NA 1-50011	341	Mag.	0.07X - 0.87X	0.10X - 1.20X	0.15X - 1.75X	0.19X - 2.33X	0.29X - 3.50X	0.48X - 5.78X	66.66 - 13.34	20.00 - 0.80
		1/4" Sensor	57.14 - 4.59	41.16 - 3.40	27.60 - 2.28	21.05 - 1.72	13.90 - 1.14	8.36 - 0.69	66.66 - 13.34	20.00 - 0.80
		1/3" Sensor	85.71 - 6.89	61.73 - 5.10	41.38 - 3.42	31.57 - 2.57	20.69 - 1.71	12.54 - 1.04	66.66 - 13.34	20.00 - 0.80
		1/2" Sensor	—	82.32 - 6.80	55.16 - 4.56	42.10 - 3.43	27.58 - 2.28	16.72 - 1.38	66.66 - 13.34	20.00 - 0.80
		2/3" Sensor	—	(1) 72.00 - 9.35	75.88 - 6.28	57.89 - 4.72	37.94 - 3.14	22.99 - 1.90	66.66 - 13.34	20.00 - 0.80
0.5X 0.009 - 0.051 NA 1-50012	165	Mag.	0.14X - 1.75X	0.20X - 2.40X	0.29X - 3.50X	0.39X - 4.66X	0.58X - 7.00X	0.96X - 11.55X	37.04 - 6.66	6.17 - 0.19
		1/4" Sensor	28.57 - 2.28	20.58 - 1.70	13.79 - 1.14	10.25 - 0.86	6.90 - 0.76	4.18 - 0.35	37.04 - 6.66	6.17 - 0.19
		1/3" Sensor	42.85 - 3.42	30.87 - 2.55	20.69 - 1.71	15.38 - 1.29	10.34 - 0.86	6.27 - 0.52	37.04 - 6.66	6.17 - 0.19
		1/2" Sensor	—	41.16 - 3.40	27.58 - 2.28	20.51 - 1.72	13.79 - 1.14	8.36 - 0.69	37.04 - 6.66	6.17 - 0.19
		2/3" Sensor	—	(1) 36.00 - 4.68	37.94 - 3.14	28.20 - 2.36	18.97 - 1.57	11.50 - 0.95	37.04 - 6.66	6.17 - 0.19
0.75X 0.014 - 0.076 NA 1-50013	108	Mag.	0.22X - 2.62X	0.29X - 3.50X	0.44X - 5.30X	0.58X - 6.98X	0.87X - 10.50X	1.44X - 17.33X	23.80 - 4.44	2.55 - 0.09
		1/4" Sensor	18.18 - 1.52	13.72 - 1.14	9.19 - 0.76	6.89 - 0.57	4.60 - 0.38	2.78 - 0.23	23.80 - 4.44	2.55 - 0.09
		1/3" Sensor	27.27 - 2.29	20.58 - 1.70	13.79 - 1.14	10.34 - 0.85	6.89 - 0.57	4.18 - 0.35	23.80 - 4.44	2.55 - 0.09
		1/2" Sensor	—	27.44 - 2.27	18.34 - 1.52	13.79 - 1.14	9.19 - 0.76	5.56 - 0.46	23.80 - 4.44	2.55 - 0.09
		2/3" Sensor	—	(1) 24.30 - 3.12	25.30 - 2.09	18.96 - 1.57	12.64 - 1.05	7.67 - 0.63	23.80 - 4.44	2.55 - 0.09
None 0.019 - 0.101 NA NA	86	Mag.	0.29X - 3.49X	0.39X - 4.70X	0.58X - 7.00X	0.77X - 9.31X	1.16X - 14.00X	1.91X - 23.10X	18.52 - 3.34	1.39 - 0.05
		1/4" Sensor	13.79 - 1.14	10.29 - 0.85	6.90 - 0.57	5.19 - 0.43	3.45 - 0.29	2.09 - 0.17	18.52 - 3.34	1.39 - 0.05
		1/3" Sensor	20.69 - 1.72	15.44 - 1.28	10.34 - 0.86	7.79 - 0.64	5.18 - 0.43	3.13 - 0.26	18.52 - 3.34	1.39 - 0.05
		1/2" Sensor	—	20.58 - 1.70	13.79 - 1.14	10.39 - 0.86	6.90 - 0.57	4.18 - 0.35	18.52 - 3.34	1.39 - 0.05
		2/3" Sensor	—	(1) 18.20 - 2.34	18.97 - 1.57	14.28 - 1.18	9.49 - 0.78	5.75 - 0.48	18.52 - 3.34	1.39 - 0.05
1.5X 0.028 - 0.151 NA 1-50014	50	Mag.	0.43X - 5.23X	0.58X - 7.00X	0.87X - 10.50X	1.16X - 14.0X	1.74X - 21.00X	2.87X - 34.65X	12.34 - 2.24	0.64 - 0.02
		1/4" Sensor	9.30 - 0.76	6.86 - 0.57	4.60 - 0.38	3.44 - 0.28	2.30 - 0.19	1.39 - 0.12	12.34 - 2.24	0.64 - 0.02
		1/3" Sensor	13.95 - 1.14	10.29 - 0.85	6.89 - 0.57	5.17 - 0.44	3.45 - 0.29	2.09 - 0.17	12.34 - 2.24	0.64 - 0.02
		1/2" Sensor	—	13.72 - 1.13	9.19 - 0.76	6.89 - 0.57	4.60 - 0.38	2.78 - 0.23	12.34 - 2.24	0.64 - 0.02
		2/3" Sensor	—	(1) 12.20 - 1.55	12.64 - 1.05	9.48 - 0.78	6.33 - 0.52	3.83 - 0.323	12.34 - 2.24	0.64 - 0.02
2.0X 0.038 - 0.202 NA 1-50015	37	Mag.	0.58X - 6.98X	0.78X - 9.40X	1.16X - 14.00X	1.54X - 18.6X	2.32X - 28.00X	3.83X - 46.20X	9.00 - 1.66	0.35 - 0.01
		1/4" Sensor	6.89 - 0.57	5.14 - 0.43	3.45 - 0.29	2.59 - 0.21	1.73 - 0.15	1.05 - 0.09	9.00 - 1.66	0.35 - 0.01
		1/3" Sensor	10.34 - 0.85	7.72 - 0.64	5.18 - 0.43	3.89 - 0.32	2.59 - 0.22	1.57 - 0.13	9.00 - 1.66	0.35 - 0.01
		1/2" Sensor	—	10.29 - 0.85	6.90 - 0.57	5.19 - 0.43	3.45 - 0.29	2.09 - 0.17	9.00 - 1.66	0.35 - 0.01
		2/3" Sensor	—	(1) 9.10 - 1.17	9.49 - 0.78	7.14 - 0.59	4.75 - 0.40	2.88 - 0.24	9.00 - 1.66	0.35 - 0.01

(1) Vignetting occurs at zoom settings less than 0.9X.

(2) NA varies depending on zoom setting. The above fields of view are measured diagonally in millimeters (Horizontal = Diagonal x 0.8 and Vertical = Diagonal x 0.6).

12X Zoom Performance Specifications

12X Zoom Combinations Lens Attachment, Prime Lens & Adapter	Working Distance (mm)	System Mag. Low-High	NA Objective Low-High	Resolve Limit Low-High (µm)	Matching Pixel Size Low-High (µm)	Depth of Field Low-High (mm)
0.25x + 12X Zoom + 0.5x	341	0.07 - 0.87	0.005 - 0.025	66.66 - 13.34	2.33 - 5.8	20.00 - 0.80
0.25x + 12X Zoom + 0.67x	341	0.10 - 1.17	0.005 - 0.025	66.66 - 13.34	3.33 - 7.80	20.00 - 0.80
0.25x + 12X Zoom + 1.0x	341	0.15 - 1.75	0.005 - 0.025	66.66 - 13.34	5.00 - 11.67	20.00 - 0.80
0.25x + 12X Zoom + 1.33x	341	0.19 - 2.33	0.005 - 0.025	66.66 - 13.34	6.33 - 15.54	20.00 - 0.80
0.25x + 12X Zoom + 2.0x	341	0.29 - 3.50	0.005 - 0.025	66.66 - 13.34	9.67 - 23.34	20.00 - 0.80
0.25x + 12X Zoom + 3.3x	341	0.48 - 5.78	0.005 - 0.025	66.66 - 13.34	16.59 - 40.53	20.00 - 0.80
0.5x + 12X Zoom + 0.5x	165	0.14 - 1.75	0.009 - 0.051	37.04 - 6.66	2.59 - 5.82	6.17 - 0.19
0.5x + 12X Zoom + 0.67x	165	0.19 - 2.35	0.009 - 0.051	37.04 - 6.66	3.60 - 7.68	6.17 - 0.19
0.5x + 12X Zoom + 1.0x	165	0.29 - 3.50	0.009 - 0.051	37.04 - 6.66	5.38 - 11.45	6.17 - 0.19
0.5x + 12X Zoom + 1.33x	165	0.39 - 4.66	0.009 - 0.051	37.04 - 6.66	7.22 - 15.51	6.17 - 0.19
0.5x + 12X Zoom + 2.0x	165	0.58 - 7.00	0.009 - 0.051	37.04 - 6.66	10.74 - 22.89	6.17 - 0.19
0.5x + 12X Zoom + 3.3x	165	0.96 - 11.55	0.009 - 0.051	37.04 - 6.66	16.64 - 50.60	6.17 - 0.19
0.75x + 12X Zoom + 0.5x	108	0.22 - 2.62	0.014 - 0.076	23.80 - 4.44	2.61 - 5.81	2.55 - 0.09
0.75x + 12X Zoom + 0.67x	108	0.29 - 3.52	0.014 - 0.076	23.80 - 4.44	3.45 - 7.73	2.55 - 0.09
0.75x + 12X Zoom + 1.0x	108	0.44 - 5.25	0.014 - 0.076	23.80 - 4.44	5.24 - 11.52	2.55 - 0.09
0.75x + 12X Zoom + 1.33x	108	0.58 - 6.98	0.014 - 0.076	23.80 - 4.44	6.90 - 15.49	2.55 - 0.09
0.75x + 12X Zoom + 2.0x	108	0.87 - 10.50	0.014 - 0.076	23.80 - 4.44	10.35 - 23.05	2.55 - 0.09
0.75x + 12X Zoom + 3.3x	108	1.44 - 17.33	0.014 - 0.076	23.80 - 4.44	16.62 - 46.34	2.55 - 0.09
None + 12X Zoom + 0.5x	86	0.29 - 3.49	0.019 - 0.101	18.52 - 3.34	2.68 - 5.82	1.39 - 0.05
None + 12X Zoom + 0.67x	86	0.39 - 4.69	0.019 - 0.101	18.52 - 3.34	3.42 - 7.74	1.39 - 0.05
None + 12X Zoom + 1.0x	86	0.58 - 7.00	0.019 - 0.101	18.52 - 3.34	5.09 - 11.55	1.39 - 0.05
None + 12X Zoom + 1.33x	86	0.77 - 9.31	0.019 - 0.101	18.52 - 3.34	7.13 - 15.54	1.39 - 0.05
None + 12X Zoom + 2.0x	86	1.16 - 14.00	0.019 - 0.101	18.52 - 3.34	10.17 - 23.10	1.39 - 0.05
None + 12X Zoom + 3.3x	86	1.91 - 23.10	0.019 - 0.101	18.52 - 3.34	16.60 - 40.54	1.39 - 0.05
1.5x + 12X Zoom + 0.5x	50	0.43 - 5.23	0.028 - 0.151	12.34 - 2.24	2.65 - 5.85	0.64 - 0.02
1.5x + 12X Zoom + 0.67x	50	0.58 - 7.04	0.028 - 0.151	12.34 - 2.24	3.45 - 7.78	0.64 - 0.02
1.5x + 12X Zoom + 1.0x	50	0.87 - 10.50	0.028 - 0.151	12.34 - 2.24	5.18 - 11.60	0.64 - 0.02
1.5x + 12X Zoom + 1.33x	50	1.16 - 14.00	0.028 - 0.151	12.34 - 2.24	7.15 - 15.68	0.64 - 0.02
1.5x + 12X Zoom + 2.0x	50	1.74 - 21.00	0.028 - 0.151	12.34 - 2.24	10.74 - 23.34	0.64 - 0.02
1.5x + 12X Zoom + 3.3x	50	2.87 - 34.65	0.028 - 0.151	12.34 - 2.24	16.62 - 40.77	0.64 - 0.02
2.0x + 12X Zoom + 0.5x	37	0.58 - 6.98	0.038 - 0.202	9.00 - 1.66	2.61 - 5.79	0.35 - 0.01
2.0x + 12X Zoom + 0.67x	37	0.78 - 9.38	0.038 - 0.202	9.00 - 1.66	3.42 - 7.79	0.35 - 0.01
2.0x + 12X Zoom + 1.0x	37	1.16 - 14.00	0.038 - 0.202	9.00 - 1.66	5.09 - 11.62	0.35 - 0.01
2.0x + 12X Zoom + 1.33x	37	1.54 - 18.60	0.038 - 0.202	9.00 - 1.66	6.93 - 15.43	0.35 - 0.01
2.0x + 12X Zoom + 2.0x	37	2.32 - 28.00	0.038 - 0.202	9.00 - 1.66	10.17 - 23.24	0.35 - 0.01
2.0x + 12X Zoom + 3.3x	37	3.83 - 46.20	0.038 - 0.202	9.00 - 1.66	16.56 - 36.04	0.35 - 0.01

Assumptions:

1. Minimum resolvable feature size is half of the threshold line pair limit. Calculation = 1/(3000 x Lens NA)
2. Matching pixel size is that which will permit the minimum feature size to overlap two pixels. Calculation = 1/2(Feature Size x System Magnification)
3. If the matching pixel size is greater than the camera pixel size, the system is "lens limited.", if less than the camera pixel size, the system is "camera limited."

## 12X UltraZoom Lens System

### Unmatched Optical Quality for High Magnification Applications

Navitar's 12X UltraZoom incorporates infinity corrected objectives in an advanced design that offers long working distances and outstanding edge flatness and clarity. The UltraZoom is also available with fine focus or with fine focus and coaxial illumination.

### 12X UltraZoom Field of View Matrix for 1-50502, 1-50503 and 1-50504 (mm)

Objective Lens Long W.D.	W.D. (mm)	Camera Formats/ Parameters	1X Adapter Low - High	1.33X Adapter Low - High	2X Adapter Low - High	3.3X Adapter Low - High
4X 0.20 NA* 1-55341	20	Mag.	(1) 2.90X - 13.35X	(2) 2.61X - 17.75X	2.19X - 26.69X	3.61X - 44.04X
		1/4" Sensor	1.38 - 0.30	1.53 - 0.23	1.83 - 0.15	1.11 - 0.09
		1/3" Sensor	2.07 - 0.45	2.30 - 0.34	2.74 - 0.22	1.66 - 0.14
		1/2" Sensor	2.76 - 0.60	3.06 - 0.45	3.65 - 0.30	2.21 - 0.18
		2/3" Sensor	3.79 - 0.82	4.21 - 0.62	5.02 - 0.41	3.04 - 0.25
5X 0.14 NA* 1-60226	34	Mag.	(1) 3.57X - 16.66X	(2) 3.26X - 22.16X	2.77X - 33.31X	4.52X - 55.05X
		1/4" Sensor	1.12 - 0.24	1.22 - 0.18	1.44 - 0.12	0.89 - 0.07
		1/3" Sensor	1.68 - 0.36	1.84 - 0.27	2.17 - 0.18	1.33 - 0.11
		1/2" Sensor	2.24 - 0.48	2.45 - 0.36	2.89 - 0.24	1.77 - 0.15
		2/3" Sensor	—	2.45 - 0.49	3.97 - 0.33	2.44 - 0.20
10X 0.28 NA* 1-60227	33	Mag.	(1) 7.14X - 33.31X	(2) 6.50X - 44.30X	5.54X - 66.63X	9.03X - 110.10X
		1/4" Sensor	0.56 - 0.12	0.61 - 0.09	0.72 - 0.06	0.44 - 0.04
		1/3" Sensor	0.84 - 0.18	0.92 - 0.13	1.08 - 0.09	0.66 - 0.05
		1/2" Sensor	1.12 - 0.24	1.23 - 0.18	1.44 - 0.12	0.89 - 0.07
		2/3" Sensor	—	1.23 - 0.25	1.99 - 0.17	1.22 - 0.10
20X 0.42 NA* 1-60228	20	Mag.	(1) 14.28X - 64.63X	(2) 13.10X - 85.96X	11.08X - 133.25X	18.07X - 220.21X
		1/4" Sensor	0.28 - 0.06	0.30 - 0.04	0.36 - 0.03	0.22 - 0.02
		1/3" Sensor	0.42 - 0.09	0.46 - 0.07	0.54 - 0.04	0.33 - 0.03
		1/2" Sensor	0.56 - 0.12	0.61 - 0.09	0.72 - 0.06	0.44 - 0.04
		2/3" Sensor	—	0.61 - 0.13	0.99 - 0.08	0.61 - 0.05
50X 0.55 NA* 1-60229	13	Mag.	(1) 35.69X - 166.57X	(2) 40.00X - 221.54X	27.50X - 333.13X	45.17X - 550.52X
		1/4" Sensor	0.11 - 0.02	0.10 - 0.02	0.14 - 0.01	0.09 - 0.007
		1/3" Sensor	0.17 - 0.04	0.15 - 0.05	0.22 - 0.02	0.13 - 0.010
		1/2" Sensor	0.22 - 0.05	0.20 - 0.04	(2) 0.17 - 0.03	0.18 - 0.010
		2/3" Sensor	—	0.20 - 0.05	0.40 - 0.03	0.24 - 0.020

NOTE: This system is not recommended for use with a 2/3" Sensor.

(1) Zoom setting at 1.5X.

(2) Zoom setting at 1.0X.

\*NA at high mag. NA varies with zoom setting.



**12X Zoom with Co-axial Illumination**

Navitar’s 12X Zoom with Internal Co-axial Illumination (1-50487) is ideal for applications involving highly reflective surfaces, such as wafers, polished samples, and fluids. Designed to provide even illumination for higher magnification applications, it provides extremely detailed resolution under incident lighting, particularly when a high resolution camera is used. Various illumination sources can be used.

**Field of View Matrix for 12X Zoom with Co-axial Illumination - 1-50487 (mm)**

Lens Attachment	W. D. (mm)	Camera Formats/ Parameters	.67X Adapter Low - High	1X Adapter Low - High	1.33X Adapter Low - High	2X Adapter Low - High	3.3X Adapter Low - High
None 0.019 - 0.101 NA (2)	86	Mag.	0.39X - 4.70X	0.58X - 7.00X	0.77X - 9.31X	1.16X - 14.00X	1.39X - 0.05X
		1/4" Sensor	10.29 - 0.85	6.90 - 0.57	5.19 - 0.43	3.45 - 0.29	2.09 - 0.17
		1/3" Sensor	15.44 - 1.28	10.34 - 0.86	7.80 - 0.64	5.18 - 0.43	3.13 - 0.26
		1/2" Sensor	20.58 - 1.70	13.79 - 1.14	10.39 - 0.86	6.90 - 0.57	4.18 - 0.35
		2/3" Sensor	(1) 18.20 - 2.34	18.97 - 1.57	14.28 - 1.18	9.49 - 0.78	5.75 - 0.48
1.5X 0.028 - 0.151 NA (2) 1-50014	50	Mag.	0.58X - 7.00X	0.87 - 10.50X	1.16X - 14.00X	1.74X - 21.00X	2.87X - 34.65X
		1/4" Sensor	6.86 - 0.57	4.60 - 0.38	3.45 - 0.29	2.30 - 0.19	1.39 - 0.12
		1/3" Sensor	10.29 - 0.85	6.89 - 0.57	5.17 - 0.43	3.45 - 0.29	2.09 - 0.17
		1/2" Sensor	13.72 - 1.13	9.19 - 0.76	6.89 - 0.57	4.60 - 0.38	2.78 - 0.23
		2/3" Sensor	(1) 12.20 - 1.55	12.64 - 1.05	9.48 - 0.79	6.33 - 0.52	3.83 - 0.32
2.0X 0.038 - 0.202 NA (2) 1-50015	37	Mag.	0.78X - 9.40X	1.16X - 14.00X	1.54X - 18.6X	2.32X - 28.00X	3.83X - 46.20X
		1/4" Sensor	5.14 - 0.43	3.45 - 0.29	2.59 - 0.22	1.73 - 0.15	1.05 - 0.09
		1/3" Sensor	7.72 - 0.64	5.18 - 0.43	3.89 - 0.32	2.59 - 0.22	1.57 - 0.13
		1/2" Sensor	10.29 - 0.85	6.90 - 0.57	5.19 - 0.43	3.45 - 0.29	2.09 - 0.17
		2/3" Sensor	(1) 9.10 - 1.17	9.49 - 0.78	7.14 - 0.59	4.75 - 0.40	2.88 - 0.24

NOTE:  
 The internal coax will illuminate a circular area of about 14 mm in diameter. Any field of view larger than 14 mm will have darkened corners.  
 Low power lens attachments can be used but produce increasing vignetting.  
 (1) Zoom Setting at 1.0X.  
 (2) NA varies depending on zoom setting

## 12X Telecentric Zoom System

The 12X Telecentric Zoom system allows users to reach a true telecentric condition to within less than 0.4° while maintaining constant perspective and magnification. This means that even if the object is slightly out of focus, the size of the image will not change. The 12X Telecentric Zoom provides field coverage from 50 mm down to 4 mm and the coaxial illumination allows clear viewing, even when working with mirror-like surfaces. Also available without coaxial illumination.

### Wide Magnification Range and Ultra Long Working Distance

When combined with the 1-50993 12X zoom the telecentric attachments will have a nominal working distance of 173mm +/- 2mm. The working distance can be modified by the factory from 165 to 186mm. Magnifications range from 0.16X to 1.94X with the 1X adapter, and 0.32X to 3.88X with the 2X adapter. Maximum field of view is 50 mm. An upper 2X F-mount adapter may be used to couple an F-Mount camera.

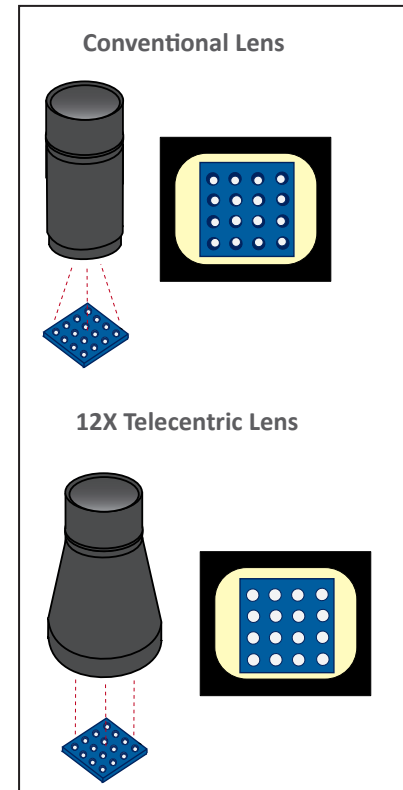
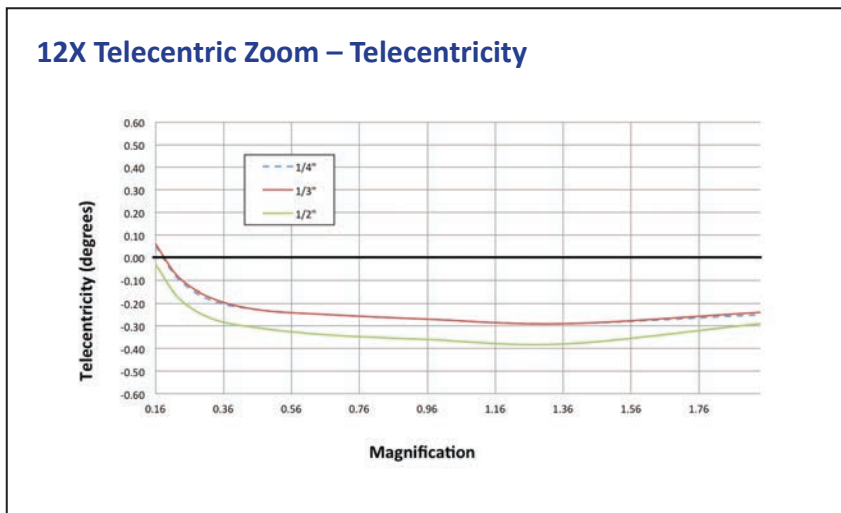

### 12X Telecentric Zoom Lens Specifications

Mag.	Telecentricity (degrees)			Object NA	Image NA	Object Depth of Focus (mm)	Telecentric Error (mm)			FOV Size (mm)			Approx. MTF (lp/mm)	Resolvable Features (µm)
	1/4"	1/3"	1/2"				1/4"	1/3"	1/2"	1/4"	1/3"	1/2"		
0.16X	0.05	0.06	-0.03	0.005	0.032	19.4	0.018	0.020	-0.009	25.0	37.3	49.7	15	66
0.23X	-0.10	-0.09	-0.18	0.007	0.031	9.7	-0.017	-0.016	-0.030	17.4	26.1	34.8	22	46
0.33X	-0.19	-0.18	-0.27	0.010	0.030	5.2	-0.016	-0.016	-0.024	12.1	18.2	24.3	30	34
0.47X	-0.23	-0.23	-0.31	0.013	0.028	3.0	-0.012	-0.012	-0.016	8.5	12.8	17.0	39	26
0.67X	-0.25	-0.25	-0.34	0.016	0.024	1.9	-0.008	-0.008	-0.011	5.9	8.9	11.9	49	21
0.96X	-0.27	-0.27	-0.36	0.020	0.021	1.3	-0.006	-0.006	-0.008	4.2	6.3	8.4	59	17
1.36X	-0.29	-0.29	-0.38	0.024	0.017	0.9	-0.004	-0.005	-0.006	2.9	4.4	5.9	71	14
1.94X	-0.25	-0.24	-0.29	0.028	0.015	0.6	-0.003	-0.003	-0.003	2.1	3.1	4.1	84	12

### NIR Lens System for Zoom 6000, 12X Zoom and Precise Eye

Navitar’s NIR Zoom lens system offers high resolution and unparalleled sensitivity for capturing microscopic images. We have specially coated the glass on our high magnification systems to be optimized for imaging in the 700-1550nm wavelength range.

Body tubes with detents and apertures or motorized systems are available.

Note: Since NIR lenses are not operating within the visible spectrum, the resulting image is slightly different than when using a standard zoom system. The standard lens resolution limits of an NIR lens are based on an assumed average wavelength of 0.5 microns and is inversely proportional to wavelength (maximum MTF = 3000xNA in the visible wavelength). Therefore, substituting a wavelength of 1.5 microns will reduce the maximum resolution by a factor of 3. In practice, this means a slight reduction of contrast at the higher wavelengths.

(When changing wavelengths in the NIR region minor refocus might be required.)

Transmission of Zoom 6.5X NIR Zoom Lens

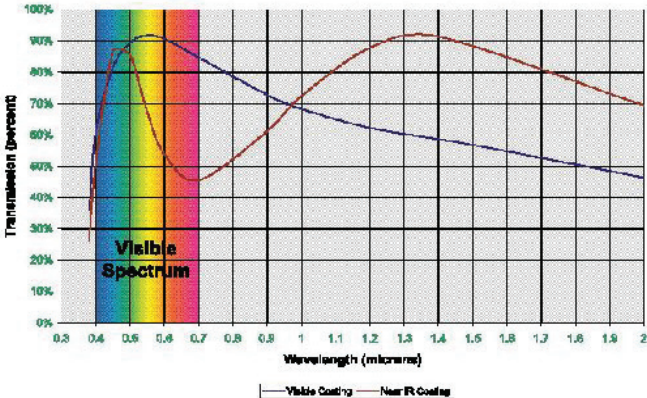

Transmission of 12X NIR Zoom Lens

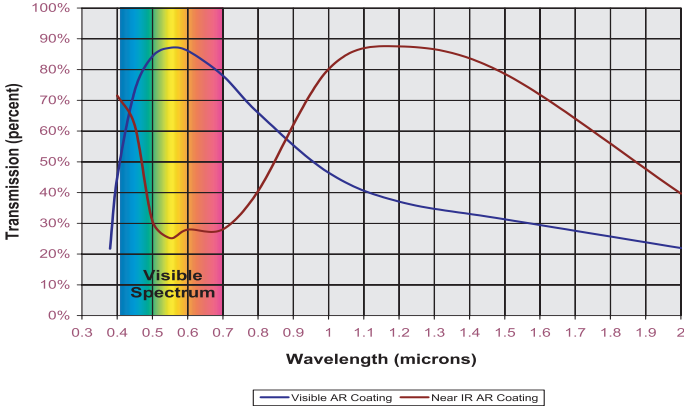

Transmission of Precise Eye NIR Lens

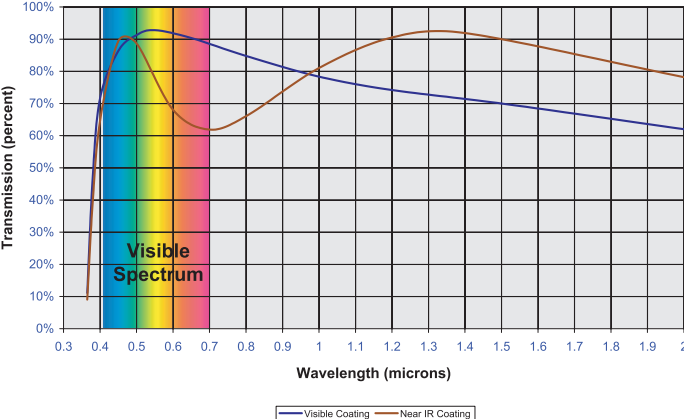

- Applications for Navitar NIR Optics**
- Wafer Characterization
  - Laser Beam Profiling
  - Optical Component Measurement & Analysis
  - Fiber Alignment & Inspection
  - Assembly & Monitoring
  - Hyperspectral Microscopy

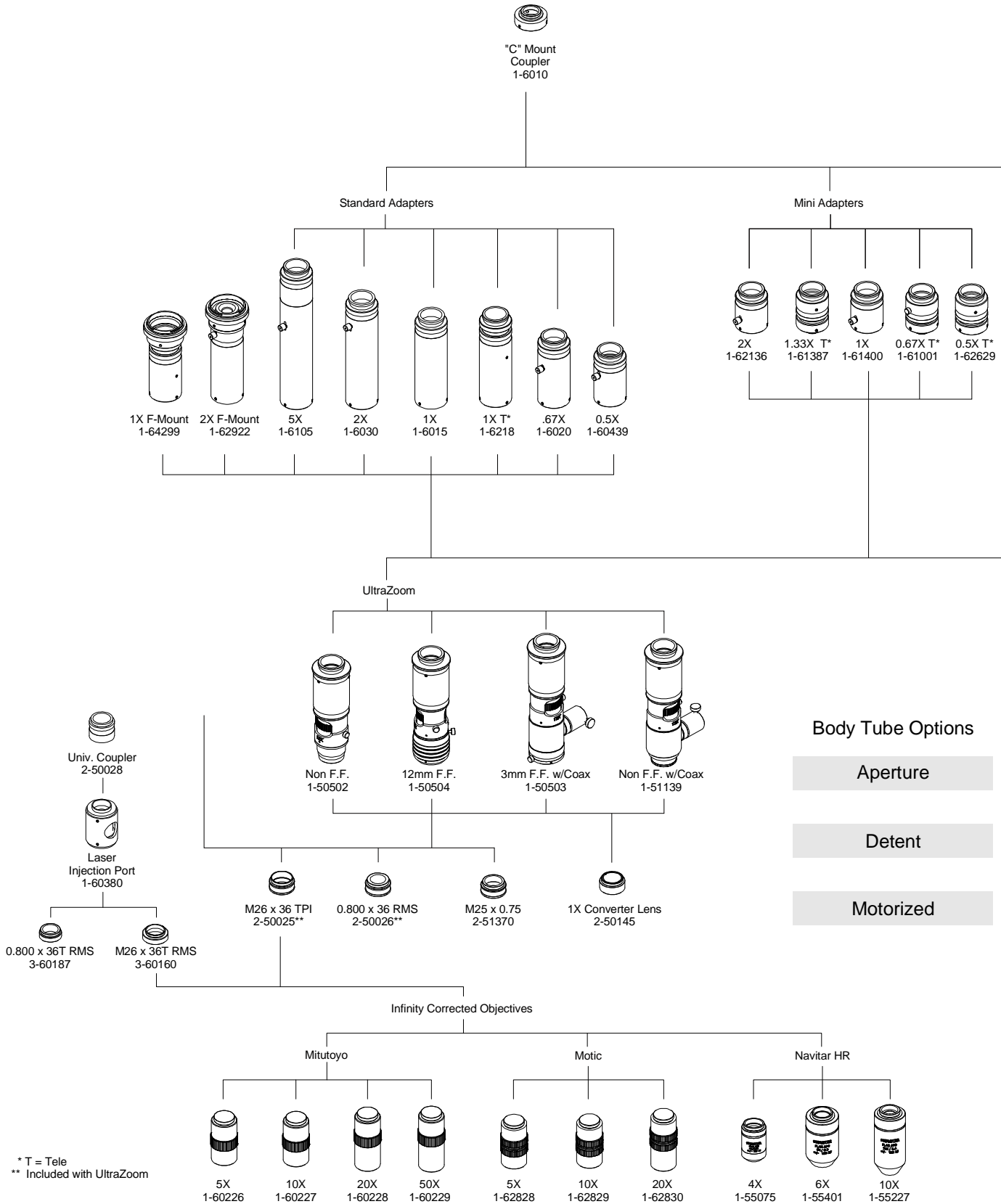



23mm  
Microscope  
Eye Piece  
(sold separately)

Eye Piece Holder  
1-6050

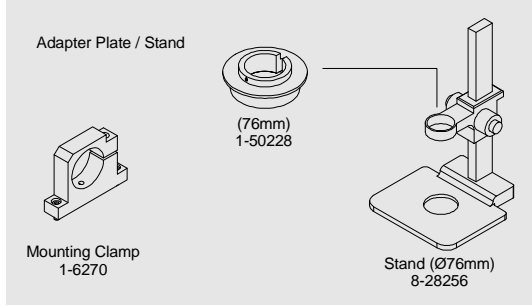

### Short Adapters

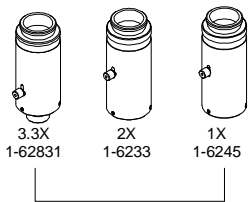

### Non-Inv. Right Angle Adapters

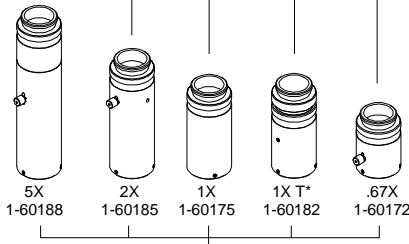

### Right Angle Adapters

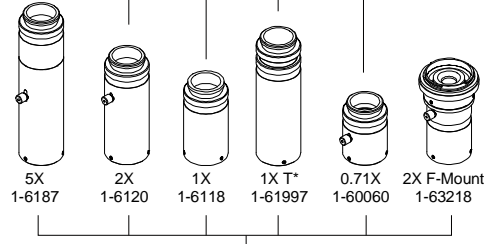

NIRA Mount w/Prism  
1-60165

RT Angle Mount  
1-6080

Analyzer  
1-60816

Aux. Viewing Port  
1-60370

### Zoom Lenses

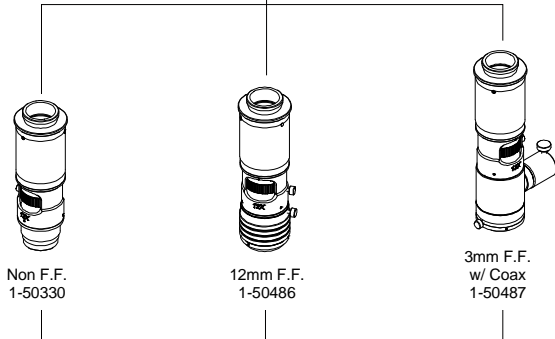

### Telecentric Zoom Lenses

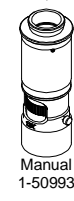

### Lens Attachments

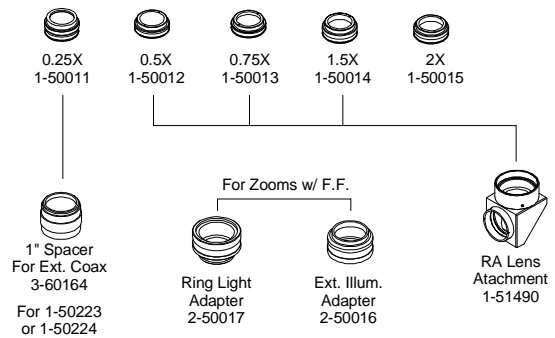

### Telecentric Attachments

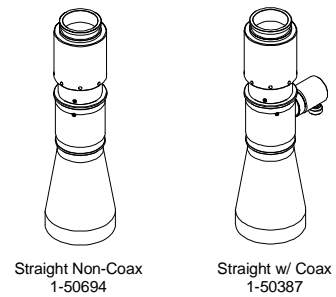

## Differential Interference Contrast (DIC) Modules

Available for Zoom 6000 and 12X Zoom Systems

Two Differential Interference Contrast (DIC) modules are available from Navitar:

**DIC Assembly Nikon-High Resolution module (1-63726)**

**Original DIC Assembly module (1-63102)**

Both modules can be used on any ultra coax version (zoom or non-zoom) of the Zoom 6000 and 12X Zoom.

DIC, when used with brightfield illumination, can often be interpreted as a true three-dimensional representation of the surface geometry. It provides a clear distinction between raised and lowered regions in the specimen being viewed.

### Using the DIC module in reflected light situations

Two polarizers, one in the illumination axis and one in the viewing axis, are crossed at 90 degrees such that when looking at a perfectly mirrored surface all light is extinguished by the second polarizer.

A prism, made from two pieces of quartz, is then placed between the illuminator beamsplitter and the objective. Due to the optical properties of the quartz, the polarized beam is split into two. The two beams, separated by a minuscule amount, are polarized at 90 degrees to each other and one beam is shifted in relation to the other, a phase shift. If the subject being viewed exhibits properties that change the length of the optical path of either beam (such as surface profiles, optical densities, etc.), both beams will experience further phase shifts.

With transverse movement of the prism the phase shifting performance of the prism may be accentuated and the final image is modified. By adding a polarization modifier, such as a 1/4 wave plate, after the illumination polarizer, the final effects are modified further.

The DIC module works with object side NAs ranging from 0.05 to 0.50, with optimum performance in the range from 0.15 to 0.4. Lens attachments, operating in the above range will serve for macro applications. Any infinity corrected objectives designed for incident light will suffice for micro applications. Operating parameters, such as magnification and FOV, will be the same as Navitar's existing tables for the zoom system being used.



3D topography of a flat panel display circuit highlighted by employing differential interference contrast (DIC) and the Zoom 6000.

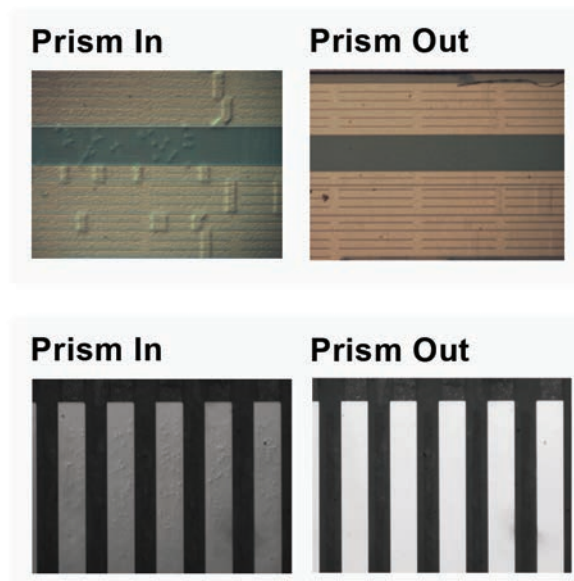

Differential Interference Contrast (DIC) System Diagram

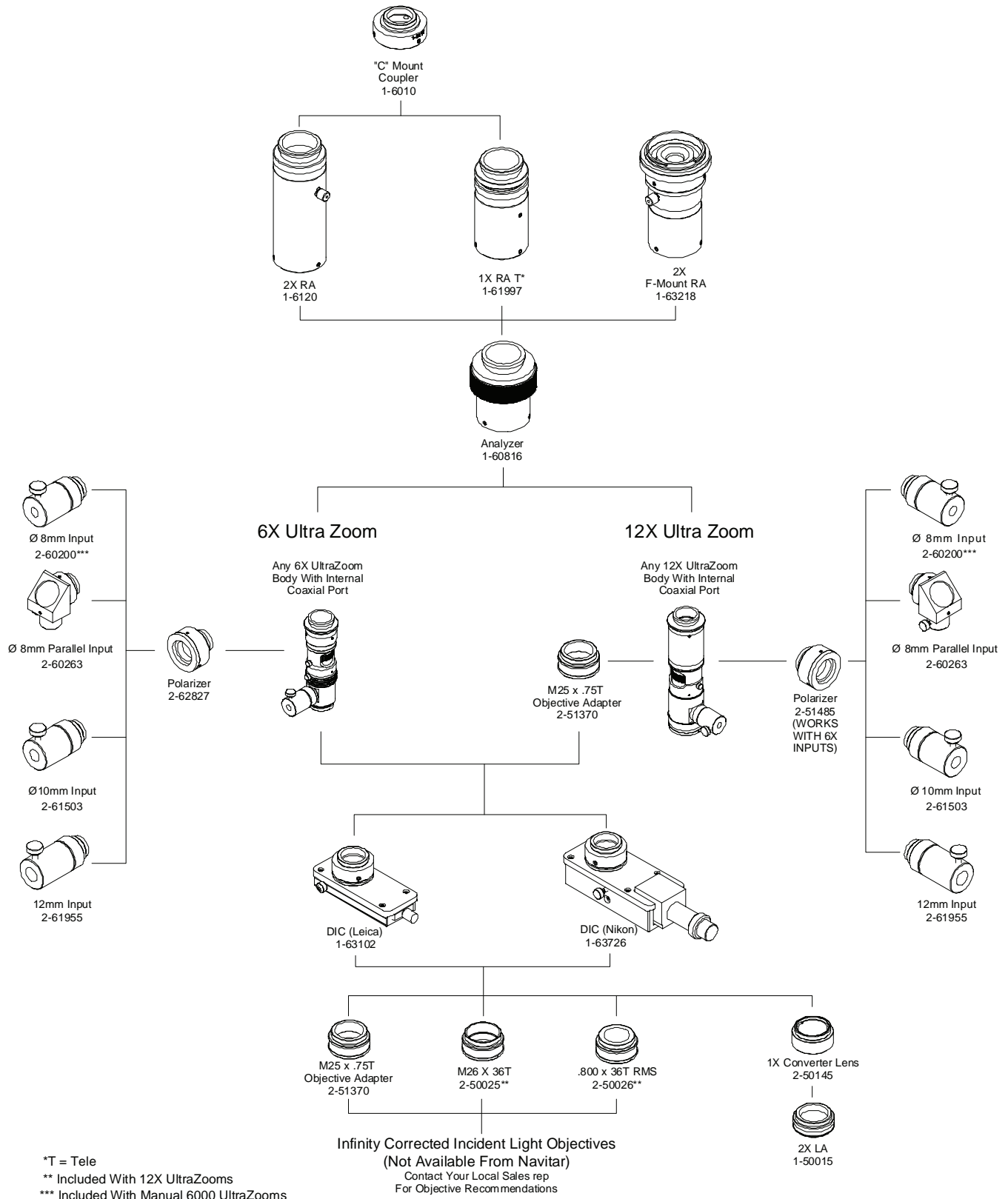

## Zoom 6000 & 12X Zoom Accessories

### Right Angle Accessories

The RA mount (1-6080) introduces a 90° bend in the optical axis, shortening the overall length of the system. The resulting image will be mirrored, thus erect and read backwards from right to left when viewed with a camera.

### Non-Inverting Right Angle Accessories

The Non-Inverting RA mount (1-60165) introduces a 90° bend in the optical axis. The use of a penta prism results in an image that is erect and reads left to right.

### Object Side Inverting & Non-Inverting Right Angle Attachments

Navitar offers a series of attachments that are fitted to the object side of our Zoom 6000 and 12X systems. See system diagrams.

### Adapter Plates

Navitar offers a variety of different microscope converter plates so you can use your zoom system with Nikon, Olympus, Meiji and Leica focus mounts.

### Polarizer/Analyzer

When used in conjunction with a polarized light source, an analyzer (1-60816) allows for cross polarization of the light in the imaging system. This reduces reflections that can deteriorate the image quality. The analyzer must be used in conjunction with the right angle adapters.

If you choose to add a polarization option to your lens system, it requires an illumination polarizer (2-62827), an analyzer above the zoom, a quarter wave plate (optional), and a shorter version of an Adapter (RA) because the analyzer shortens the optical path by 50.8 mm.

### Aperture Control

Lens systems can be designed with an internal iris that can be manipulated without cutting into the field of view. The iris permits the reduction of image intensity at the image plane, which reduces “blooming” and other damaging artifacts. The iris can also be closed down to essentially “stop down” the lens to reduce the Numerical Aperture of the lens. This narrowing of the light gathering cone produces a significant increase in the depth of field.

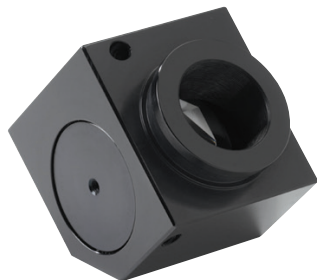

### Laser Injection Port

Navitar’s Laser Injection Port (1-60380) provides a means of introducing a laser beam into the Zoom 6000 system. It is normally used between the end of the zoom lens and an infinity corrected objective so that the objective condenses the laser beam into a highly concentrated spot. A beamsplitter cube, rather than a plate, is used to minimize aberrations.

### Auxiliary Viewing Port

The Auxiliary Viewing Port (1-60370) provides a second output port for an additional camera or for direct vision using an eyepiece. A 50/50 beam splitter cube is used for minimal image degradation.

### Infinity Corrected Objectives

Infinity Corrected Objectives can be attached to any UltraZoom to increase the system magnification and decrease working distance.

### Quarter Wave Plate

A Quarter Wave Plate (1-60981) has the unique feature of taking the polarized light and circularly polarizing the beam (sort of a spiraling effect). When this beam reflects off a specular object, the spiraling reverses, and upon re-striking the quarter wave plate, the beam is extinguished. This technique is useful in eliminating reflections from wafers and circuit boards. For use with Zoom 6000 Coaxial lens.

### Zoom Xtender

The Xtender is designed to offer working distances beyond that achievable with standard attachments.

### F-Mount Zoom Adapters

F-mount adapters allow use of F-mount Cameras. Not recommended for use with the 12X Zoom System with sensors over 16 mm, or the Zoom 6000 sensors over 30mm.



Zoom 6000 Configurations

Basic Zoom 6000 configuration

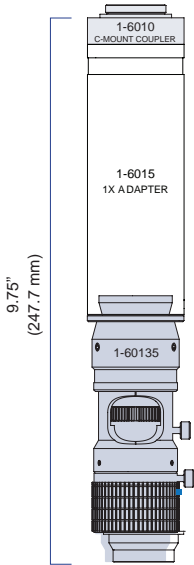

Zoom 6000 configuration with coaxial illumination

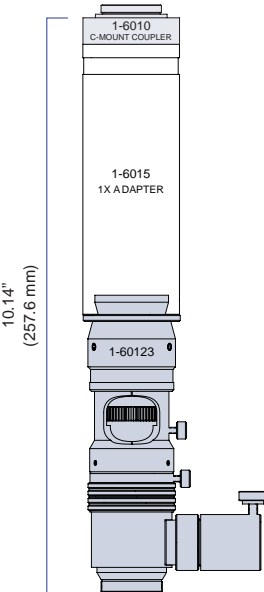

Zoom 6000 configuration with motorization

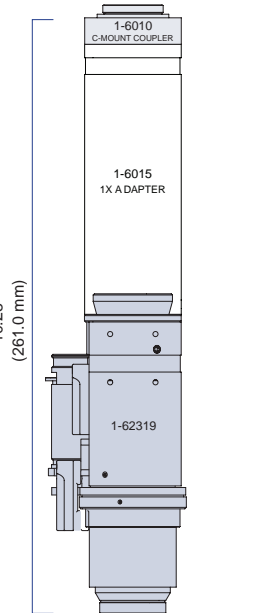

Zoom 6000 configuration with motorization and right angle adapter

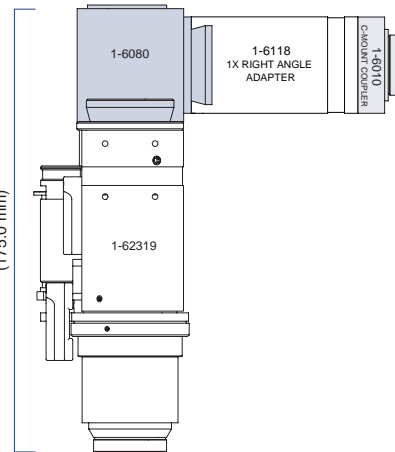

12X Zoom Configurations

Basic 12X Zoom configuration

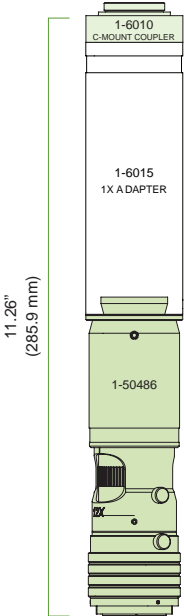

12X Zoom configuration with coaxial illumination

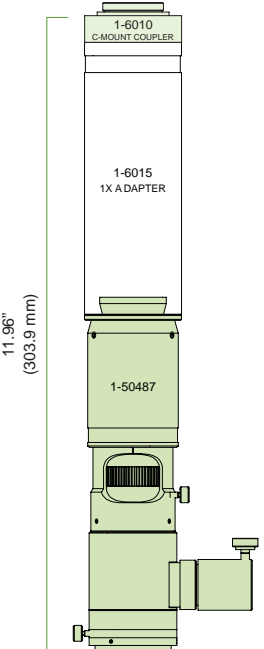

12X Zoom configuration with motorization

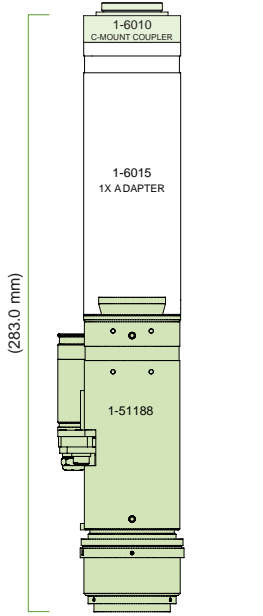

12X Zoom configuration with motorization and right angle adapter

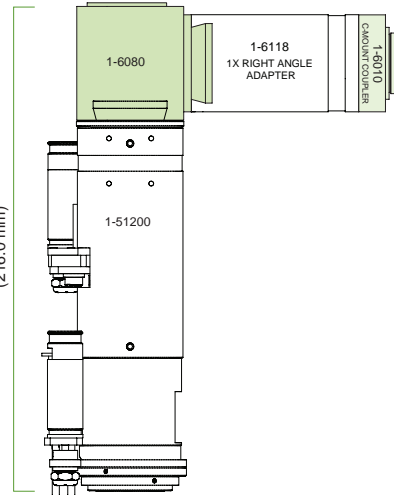

## More Robust Design

Navitar's motorization design, available on the 12X and Zoom 6000 systems, integrates magnetic Hall Effect sensors with reference position location. Hall Effect sensors are solid state devices with no moving parts.

## Integrated Hall Effect Solid State Sensor Technology

- Unaffected by ambient light
- Unaffected by environmental contamination
- Unaffected by line voltage

Users can choose to motorize both the zoom and focus axis, or just the zoom. Navitar offers three different motor types:

- 2-Phase Stepping Motor (Faulhaber)
- 5-Phase Stepping Motor (Oriental, Vexta)
- DC Servo with Encoder (Faulhaber)

Most motorized lenses are built to order, which may affect standard lead times.



## Motorized Zoom 6000 Options

Version	Motor Type		
	2 $\phi$ Stepper	5 $\phi$ Stepper	Encoded/Servo
12 mm Motorized Fine Focus	1-62318	1-64426	1-62310
3 mm Motorized Fine Focus w/ Coax	1-62319	1-64428	1-62311
12 mm Manual Fine Focus	1-62523	1-64430	1-62522
3 mm Manual Fine Focus w/ Coax	1-62525	1-64432	1-62524
Non Fine Focus, Non Coax	1-62605	1-64434	1-62606
Non Fine Focus w/ Coax	1-62608	1-64436	1-62609

## Motorized 12X Zoom Options

Version	Motor Type		
	2 $\phi$ Stepper	5 $\phi$ Stepper	Encoded/Servo
12 mm Motorized Fine Focus	1-51188	1-52000	1-51190
3 mm Motorized Fine Focus w/ Coax	1-51200	1-52002	1-51202
12 mm Manual Fine Focus	1-51319	1-52004	1-51337
3 mm Manual Fine Focus w/ Coax	1-51311	1-52006	1-51338
Non Fine Focus, Non Coax	1-51314	1-52008	1-51335
Non Fine Focus w/ Coax	1-51318	1-52010	1-51336

## Motorized Zoom 6000 UltraZoom Options

Version	Motor Type		
	2 $\phi$ Stepper	5 $\phi$ Stepper	Encoded/Servo
12 mm Motorized Fine Focus	1-62316	1-64439	1-62308
3 mm Motorized Fine Focus w/ Coax	1-62317	1-64441	1-62309
12 mm Manual Fine Focus	1-62517	1-64443	1-62516
3 mm Manual Fine Focus w/ Coax	1-62639	1-64445	1-62633
Non Fine Focus, Non Coax	1-62637	1-64447	1-62631
Non Fine Focus w/ Coax	1-62638	1-64449	1-62632

## Motorized 12X UltraZoom Options

Version	Motor Type		
	2 $\phi$ Stepper	5 $\phi$ Stepper	Encoded/Servo
12 mm Motorized Fine Focus	1-51192	1-52013	1-51194
3 mm Motorized Fine Focus w/ Coax	1-51196	1-52015	1-51198
12 mm Manual Fine Focus	1-51325	1-52017	1-51333
3 mm Manual Fine Focus w/ Coax	1-51326	1-52019	1-51334
Non Fine Focus, Non Coax	1-51320	1-52021	1-51331
Non Fine Focus w/ Coax	1-51324	1-52023	1-51332

NOTE: Zooms using 5 phase stepping motors require user to order the correct cable harness between zoom and controller.

## Mounting Options for Motorized Lenses

Navitar also offers flat mounting assemblies for easy integration of our motorized zoom lenses into any application. The flat mounts securely attach to the zoom body using 4 hex screws. Four additional ¼-20 thru holes are integrated into the mounts to provide a robust attachment point to a machine surface.

6X	12X
1-62572 (Standard)	1-51272 (Standard)
1-64546 (Imperial)	1-52045 (Imperial)
1-64547 (Metric)	1-52046 (Metric)

## Coaxial Inputs for Motorized Lenses

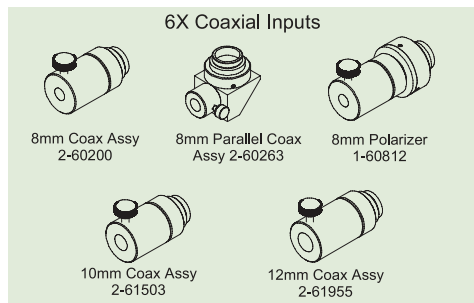

Coaxial Inputs for Zoom 6000	Description and Fiber Input Size
2-60200	8 mm diameter
2-61503	10 mm diameter
2-61955	12 mm diameter
2-60263	8 mm parallel coaxial
1-60812	8 mm polarizer

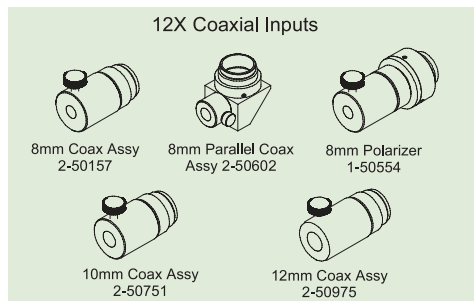

Coaxial Inputs for 12X Zoom	Description and Fiber Input Size
2-50157	8 mm diameter
2-50751	10 mm diameter
2-50975	12 mm diameter
2-50602	8 mm parallel coaxial
1-50554	8 mm polarizer

\*Coax parts must be ordered separately for all motorized lenses.

## Motorized Controllers

All Navitar 12X and Zoom 6000 motorized systems can be ordered with a fully integrated control system, featuring single or dual axis control via serial RS-232 or USB.

Software includes Demo Application User Interface “GUI” for simple axis control. Connections are made via two 15-pin high density d-sub connectors. Arrangements can be made for supplying the underlying software code for OEM platform assimilation.

## System Requirements

### Operating Systems Supported for Serial RS-232 and USB:

- Windows 7, 8.1, 10 (32 & 64 bit)

### Computer Requirements:

- Windows Operating System (OS)
- Port: 1 serial or 1 USB port (can be a hub)
- Hard Disk: 1 M bytes
- RAM: Same as OS (if OS works, controller will work)

## Available Control Systems

Part #	Description
<b>Board Level</b>	
1-40241	2 phase stepper PCB Kit
1-40167	5 phase stepper PCB Kit
1-40242	Encoded PCB Kit
<b>Enclosures</b>	
1-40233	2 phase flanged enclosure
1-40234	2 phase desktop enclosure
1-40168	5 phase flanged enclosure
1-40169	5 phase desktop enclosure
1-40237	Encoded flanged enclosure
1-40238	Encoded desktop enclosure
<b>Accessories &amp; Power Supplies</b>	
1-40170	5 phase cable harness
8-62503	24V Domestic power supply
8-62501	USB cable (6 feet)
8-62502	RS-232 cable (6 feet)
1-40040	24V Universal Power Supply w/ Plug Kit

Part Number	Output Connector	Input Voltage				Universal Plug Kit
1-62504	2.1mm x 5.5mm	86-286vAC	24vDC	1.5A		Std. US Plug
8-62503	2.1mm x 5.5mm	120vAC	24vDC	1.05A		Std. US Plug
1-40040	2.1mm x 5.5mm	90-264vAC	24vDC	1.25A	Medical Rated	Yes

## High Magnification for Fixed Inspection Applications

Navitar's Precise Eye series of lenses is designed to provide superior optical performance over standard C-mount video lenses.



- High resolution, f/4.5 optical quality for high precision measurement and inspection
- Long working distance makes lighting and handling easier
- Coaxial lighting available for shadow-free illumination
- Compatible with high-magnification infinity corrected objectives
- Mechanically stable for the most demanding vibration environments
- Modular design for flexibility
- Optics attach to any C-mount camera
- Short tube length (~4 inches/101.6mm) and small diameter (1.25 inches/31.8mm)
- Allows for coaxial illumination and/or 3 mm fine focus
- High transmission (>70%) over the visible to near IR spectrum

### Precise Eye Field of View Matrix (mm at nominal working distance)

Lens Attachment	W.D. (mm)	Camera Format & Parameters	0.5X Adapter 1-62088 H x V	0.67X Adapter 1-61453 H x V	1.0X Adapter 1-61445 H x V	1.33X Adapter 1-61448 H x V	2.0X Adapter 1-61450 H x V
0.25X 0.018 NA DOF 1.59 mm 1-6044	310 (nominal)	Mag.	0.23X	0.30X	0.45X	0.60X	0.90X
		1/4" Sensor	14.2 x 10.7	10.6 x 8.0	7.1 x 5.3	5.3 x 4.0	3.6 x 2.7
	282-351 (1) W.D. Range	1/3" Sensor	21.3 x 16.0	15.9 x 11.9	10.7 x 8.0	8.0 x 6.0	5.3 x 4.0
		1/2" Sensor	28.4 x 21.3	21.2 x 15.9	14.2 x 10.7	10.7 x 8.0	7.1 x 5.3
		2/3" Sensor	39.1 x 29.3	29.2 x 21.9	19.6 x 14.7	14.7 x 11.0	9.8 x 7.3
0.5X 0.035 NA DOF 0.40 mm 1-60110	175 (nominal)	Mag.	0.45X	0.60X	0.90X	1.20X	1.80X
		1/4" Sensor	7.1 x 5.3	5.3 x 4.0	3.6 x 2.7	2.7 x 2.0	1.8 x 1.3
	170-190 (1) W.D. Range	1/3" Sensor	10.7 x 8.0	8.0 x 6.0	5.3 x 4.0	4.0 x 3.0	2.7 x 2.0
		1/2" Sensor	14.2 x 10.7	10.6 x 8.0	7.1 x 5.3	5.3 x 4.0	3.6 x 2.7
		2/3" Sensor	19.6 x 14.7	14.6 x 10.9	9.8 x 7.3	7.4 x 5.5	4.9 x 3.7
0.75X 0.054 NA DOF 0.18 mm 1-60111	113 (nominal)	Mag.	0.68X	0.90X	1.35X	1.80X	2.70X
		1/4" Sensor	4.7 x 3.6	3.5 x 2.7	2.4 x 1.8	1.8 x 1.3	1.2 x 0.9
	110-120 (1) W.D. Range	1/3" Sensor	7.1 x 5.3	5.3 x 4.0	3.6 x 2.7	2.7 x 2.0	1.8 x 1.3
		1/2" Sensor	9.5 x 7.1	7.1 x 5.3	4.7 x 3.6	3.6 x 2.7	2.4 x 1.8
		2/3" Sensor	13.0 x 9.8	9.7 x 7.3	6.5 x 4.9	4.9 x 3.7	3.3 x 2.4
None 0.070 NA DOF 0.10 mm	92 (nominal)	Mag.	0.90X	1.21X	1.80X	2.39X	3.60X
		1/4" Sensor	3.6 x 2.7	2.7 x 2.0	1.8 x 1.3	1.3 x 1.0	0.9 x 0.7
	90-93 (1) W.D. Range	1/3" Sensor	5.3 x 4.0	4.0 x 3.0	2.7 x 2.0	2.0 x 1.5	1.3 x 1.0
		1/2" Sensor	7.1 x 5.3	5.3 x 4.0	3.6 x 2.7	2.7 x 2.0	1.8 x 1.3
		2/3" Sensor	9.8 x 7.3	7.3 x 5.5	4.9 x 3.7	3.7 x 2.8	2.4 x 1.8
1.5X 0.106 NA DOF 0.04 mm 1-60112	51 (nominal)	Mag.	1.35X	1.81X	2.70X	3.59X	5.40X
		1/4" Sensor	2.4 x 1.8	1.8 x 1.3	1.2 x 0.9	0.9 x 0.7	0.6 x 0.4
	49-51 (1) W.D. Range	1/3" Sensor	3.6 x 2.7	2.7 x 2.0	1.8 x 1.3	1.3 x 1.0	0.9 x 0.7
		1/2" Sensor	4.7 x 3.6	3.5 x 2.7	2.4 x 1.8	1.8 x 1.3	1.2 x 0.9
		2/3" Sensor	6.5 x 4.9	4.9 x 3.6	3.3 x 2.4	2.4 x 1.8	1.6 x 1.2
2.0X 0.142 NA DOF 0.02 mm 1-60113	36 (nominal)	Mag.	1.80X	2.41X	3.60X	4.79X	7.20X
		1/4" Sensor	1.8 x 1.3	1.3 x 1.0	0.9 x 0.7	0.7 x 0.5	0.4 x 0.3
	35-36 (1) W.D. Range	1/3" Sensor	2.7 x 2.0	2.0 x 1.5	1.3 x 1.0	1.0 x 0.8	0.7 x 0.5
		1/2" Sensor	3.6 x 2.7	2.7 x 2.0	1.8 x 1.3	1.3 x 1.0	0.9 x 0.7
		2/3" Sensor	4.9 x 3.7	3.6 x 2.7	2.4 x 1.8	1.8 x 1.4	1.2 x 0.9

NOTE: (1) Working distance range when using 3 mm fine focus. Field of view will change with shorter or longer working distances.



Precise Eye Performance Specifications

Precise Eye Combinations Lens Attachment + Precise Eye + Adapter	W.D. (mm)	Magnification	NA Object Side	Resolve Limits ( $\mu\text{m}$ )	Depth of Field (mm)	Required Matching Pixel Size ( $\mu\text{m}$ )
0.25x + Precise Eye + 0.5x	310	0.23x	0.018	18.8	1.59	2.1
0.25x + Precise Eye + 0.67x	310	0.30x	0.018	18.8	1.59	2.8
0.25x + Precise Eye + 1.0x	310	0.45x	0.018	18.8	1.59	4.2
0.25x + Precise Eye + 1.33x	310	0.60x	0.018	18.8	1.59	5.6
0.25x + Precise Eye + 2.0x	310	0.90x	0.018	18.8	1.59	8.4
0.5x + Precise Eye + 0.5x	175	0.45x	0.035	9.4	0.40	2.1
0.5x + Precise Eye + 0.67x	175	0.60x	0.035	9.4	0.40	2.8
0.5x + Precise Eye + 1.0x	175	0.90x	0.035	9.4	0.40	4.2
0.5x + Precise Eye + 1.33x	175	1.20x	0.035	9.4	0.40	5.6
0.5x + Precise Eye + 2.0x	175	1.80x	0.035	9.4	0.40	8.4
0.75x + Precise Eye + 0.5x	113	0.68x	0.054	6.2	0.18	2.1
0.75x + Precise Eye + 0.67x	113	0.90x	0.054	6.2	0.18	2.8
0.75x + Precise Eye + 1.0x	113	1.35x	0.054	6.2	0.18	4.2
0.75x + Precise Eye + 1.33x	113	1.80x	0.054	6.2	0.18	5.6
0.75x + Precise Eye + 2.0x	113	2.70x	0.054	6.2	0.18	8.4
None + Precise Eye + 0.5x	92	0.90x	0.071	4.6	0.10	2.1
None + Precise Eye + 0.67x	92	1.21x	0.071	4.6	0.10	2.8
None + Precise Eye + 1.0x	92	1.80x	0.071	4.6	0.10	4.2
None + Precise Eye + 1.33x	92	2.39x	0.071	4.6	0.10	5.6
None + Precise Eye + 2.0x	92	3.60x	0.071	4.6	0.10	8.4
1.5x + Precise Eye + 0.5x	51	1.35x	0.106	3.2	0.04	2.1
1.5x + Precise Eye + 0.67x	51	1.81x	0.106	3.2	0.04	3.0
1.5x + Precise Eye + 1.0x	51	2.70x	0.106	3.2	0.04	4.4
1.5x + Precise Eye + 1.33x	51	3.59x	0.106	3.2	0.04	5.8
1.5x + Precise Eye + 2.0x	51	5.40x	0.106	3.2	0.04	8.6
2.0x + Precise Eye + 0.5x	36	1.80x	0.142	2.4	0.02	2.1
2.0x + Precise Eye + 0.67x	36	2.41x	0.142	2.4	0.02	2.8
2.0x + Precise Eye + 1.0x	36	3.60x	0.142	2.4	0.02	4.2
2.0x + Precise Eye + 1.33x	36	4.79x	0.142	2.4	0.02	5.6
2.0x + Precise Eye + 2.0x	36	7.20x	0.142	2.4	0.02	8.4

Assumptions:

1. Minimum resolvable feature size is half of the threshold line pair limit. Calculation =  $1/(3000 \times \text{Lens NA})$
2. Matching pixel size is that which will permit the minimum feature size to overlap two pixels. Calculation =  $1/2(\text{Feature Size} \times \text{System Magnification})$
3. If the matching pixel size is greater than the camera pixel size, the system is "lens limited.", if it's less than the camera pixel size, the system is "camera limited."

## Ultra Precise Eye System Greater Resolution and Magnification

Navitar offers a variety of Ultra Precise Eye systems ideal for high magnification applications. The advanced design produces outstanding contrast and precision, while providing higher resolution and magnification than the standard Precise Eye. These systems incorporate infinity corrected objectives to provide long working distances and excellent edge flatness and clarity. The Ultra Precise Eye is also available with fine focus (1-61521) or with fine focus and coaxial illumination (1-61522).



### Ultra Precise Eye Magnification Matrix

Infinity Corrected Objective	W.D. (mm)	Camera Format & Parameters	0.5X Adapter 1-62088 H x V	0.67X Adapter 1-61453 H x V	1.0X Adapter 1-61445 H x V	1.33X Adapter 1-61448 H x V	2.0X Adapter 1-61450 H x V
4X 0.20 NA 1-55341	20	Mag.	1.78X	2.39X	3.56X	4.73X	7.12X
		1/4" Sensor	1.80 x 1.35	1.34 x 1.01	0.90 x 0.67	0.68 x 0.51	0.45 x 0.34
		1/3" Sensor	2.70 x 2.02	2.01 x 1.51	1.35 x 1.01	1.01 x 0.76	0.67 x 0.51
		1/2" Sensor	3.60 x 2.70	2.68 x 2.01	1.80 x 1.35	1.35 x 1.01	0.90 x 0.67
		2/3" Sensor	-	-	2.47 x 1.85	1.86 x 1.39	1.24 x 0.93
5X 0.14 NA 1-60226	34	Mag.	2.23X	2.98X	4.45X	5.92X	8.90X
		1/4" Sensor	1.44 x 1.08	1.07 x 0.80	0.72 x 0.54	0.54 x 0.41	0.36 x 0.27
		1/3" Sensor	2.16 x 1.62	1.61 x 1.21	1.08 x 0.81	0.81 x 0.61	0.54 x 0.40
		1/2" Sensor	2.88 x 2.16	2.15 x 1.61	1.44 x 1.08	1.08 x 0.81	0.72 x 0.54
		2/3" Sensor	-	-	1.98 x 1.48	1.49 x 1.12	0.99 x 0.74
10X 0.28 NA 1-60227	33	Mag.	4.45X	5.96X	8.90X	11.80X	17.80X
		1/4" Sensor	0.72 x 0.54	0.54 x 0.40	0.36 x 0.27	0.27 x 0.20	0.18 x 0.13
		1/3" Sensor	1.08 x 0.81	0.80 x 0.60	0.54 x 0.40	0.41 x 0.30	0.27 x 0.20
		1/2" Sensor	1.44 x 1.08	1.07 x 0.80	0.72 x 0.54	0.54 x 0.41	0.36 x 0.27
		2/3" Sensor	-	-	0.99 x 0.74	0.74 x 0.56	0.49 x 0.37
20X 0.42 NA 1-60228	20	Mag.	8.90X	11.90X	17.80X	23.70X	35.60X
		1/4" Sensor	0.36 x 0.27	0.27 x 0.20	0.18 x 0.13	0.14 x 0.10	0.09 x 0.07
		1/3" Sensor	0.54 x 0.40	0.40 x 0.30	0.27 x 0.20	0.20 x 0.15	0.13 x 0.10
		1/2" Sensor	0.72 x 0.54	0.54 x 0.40	0.36 x 0.27	0.27 x 0.20	0.18 x 0.13
		2/3" Sensor	-	-	0.49 x 0.37	0.37 x 0.28	0.25 x 0.19
50X 0.55 NA 1-60229	13	Mag.	22.30X	29.80X	44.50X	59.20X	89.00X
		1/4" Sensor	0.14 x 0.11	0.11 x 0.08	0.07 x 0.05	0.05 x 0.04	0.04 x 0.03
		1/3" Sensor	0.22 x 0.16	0.16 x 0.12	0.11 x 0.08	0.08 x 0.06	0.05 x 0.04
		1/2" Sensor	0.29 x 0.22	0.21 x 0.16	0.14 x 0.11	0.11 x 0.08	0.07 x 0.05
		2/3" Sensor	-	-	0.20 x 0.15	0.15 x 0.11	0.10 x 0.07

NOTE: The O-I remains constant for each body tube (main assembly) regardless of which infinity corrected objective and adapter are selected:  
 1-61517 I-O = 219 mm,  
 1-61521 I-O = 243 mm, 1-61522 I-O = 263 mm. NA varies with zoom setting.

## Precise Eye with Co-axial Illumination

Navitar’s Precise Eye with Internal Co-axial Illumination (1-61446) is an ideal solution for applications involving highly reflective surfaces, such as wafers, polished samples, and fluids. Designed to provide even illumination for higher magnification applications, coaxial illumination provides extremely detailed resolution, particularly when a high resolution camera is used.

### Precise Eye Field of View Matrix for Co-axial Illumination (mm at nominal working distance)

Lens Attachment	W.D. (mm)	Camera Format & Parameters	0.5X Adapter 1-62088 H x V	0.67X Adapter 1-61453 H x V	1.0X Adapter 1-61445 H x V	1.33X Adapter 1-61448 H x V	2.0X Adapter 1-61450 H x V
0.5X 0.035 NA DOF 0.40 mm 1-60110	175 (nominal)	Mag.	0.45X	0.60X	0.90X	1.20X	1.80X
		1/4" Sensor	7.1 x 5.3	5.3 x 4.0	3.6 x 2.7	2.7 x 2.0	1.8 x 1.3
	170-190 (1) W.D. Range	1/3" Sensor	10.7 x 8.0*	8.0 x 6.0	5.3 x 4.0	4.0 x 3.0	2.7 x 2.0
		1/2" Sensor	14.2 x 10.7*	10.6 x 8.0*	7.1 x 5.3	5.3 x 4.0	3.6 x 2.7
		2/3" Sensor	19.6 x 14.7*	14.6 x 10.9*	9.8 x 7.3*	7.4 x 5.5	4.9 x 3.7*
0.75X 0.054 NA DOF 0.17 mm 1-60111	113 (nominal)	Mag.	0.68X	0.90X	1.35X	1.80X	2.70X
		1/4" Sensor	4.7 x 3.6	3.5 x 2.7	2.4 x 1.8	1.8 x 1.3	1.2 x 0.9
	110-120 (1) W.D. Range	1/3" Sensor	7.1 x 5.3	5.3 x 4.0	3.6 x 2.7	2.7 x 2.0	1.8 x 1.3
		1/2" Sensor	9.5 x 7.1*	7.1 x 5.3	4.7 x 3.6	3.6 x 2.7	2.4 x 1.8
		2/3" Sensor	13.0 x 9.8*	9.7 x 7.3*	6.5 x 4.9	4.9 x 3.7	3.3 x 2.4*
None 0.070 NA DOF 0.10 mm	92 (nominal)	Mag.	0.90X	1.21X	1.80X	2.39X	3.60X
		1/4" Sensor	3.6 x 2.7	2.7 x 2.0	1.8 x 1.3	1.3 x 1.0	0.9 x 0.7
	90-93 (1) W.D. Range	1/3" Sensor	5.3 x 4.0	4.0 x 3.0	2.7 x 2.0	2.0 x 1.5	1.3 x 1.0
		1/2" Sensor	7.1 x 5.3	5.3 x 4.0	3.6 x 2.7	2.7 x 2.0	1.8 x 1.3
		2/3" Sensor	9.8 x 7.3*	7.3 x 5.5*	4.9 x 3.7	3.7 x 2.8	2.4 x 1.8*
1.5X 0.106 NA DOF 0.046 mm 1-60112	51 (nominal)	Mag.	1.35X	1.81X	2.70X	3.59X	5.40X
		1/4" Sensor	2.4 x 1.8	1.8 x 1.3	1.2 x 0.9	0.9 x 0.7	0.6 x 0.4
	49-51 (1) W.D. Range	1/3" Sensor	3.6 x 2.7	2.7 x 2.0	1.8 x 1.3	1.3 x 1.0	0.9 x 0.7
		1/2" Sensor	4.7 x 3.6	3.5 x 2.7	2.4 x 1.8	1.8 x 1.3	1.2 x 0.9
		2/3" Sensor	6.5 x 4.9	4.9 x 3.6*	3.3 x 2.4	2.5 x 1.8	1.6 x 1.2*
2.0X 0.142 NA DOF 0.025 mm 1-60113	36 (nominal)	Mag.	1.80X	2.41X	3.60X	4.79X	7.20X
		1/4" Sensor	1.8 x 1.3	1.3 x 1.0	0.9 x 0.7	0.7 x 0.5	0.4 x 0.3
	35-36 (1) W.D. Range	1/3" Sensor	2.7 x 2.0	2.0 x 1.5	1.3 x 1.0	1.0 x 0.8	0.7 x 0.5
		1/2" Sensor	3.6 x 2.7	2.7 x 2.0	1.8 x 1.3	1.3 x 1.0	0.9 x 0.7
		2/3" Sensor	4.9 x 3.7	3.6 x 2.7*	2.4 x 1.8	1.8 x 1.4	1.2 x 0.9*

NOTE: \*The internal coax will illuminate a circular area of about 11 mm in diameter. Any field of view larger than 11 mm will have darkened corners.  
(1) Working distance range when using 3 mm fine focus. Field of view will change with shorter or longer working distance.

## Adapter Tubes

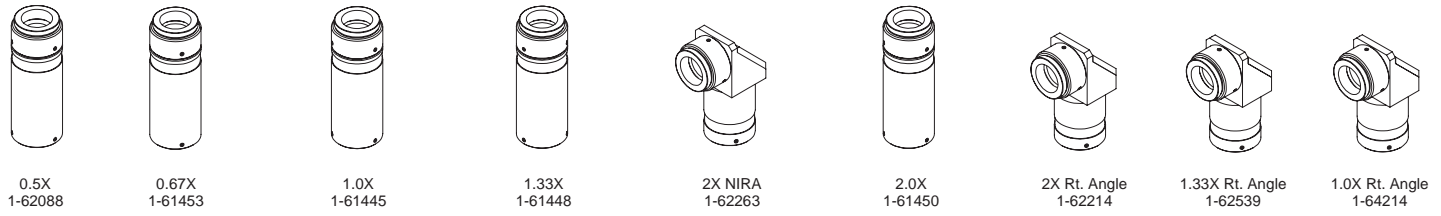

## Ultra Body Tubes

## Ultra Motorized Body Tubes

## Right Angle Body Tubes

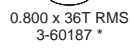
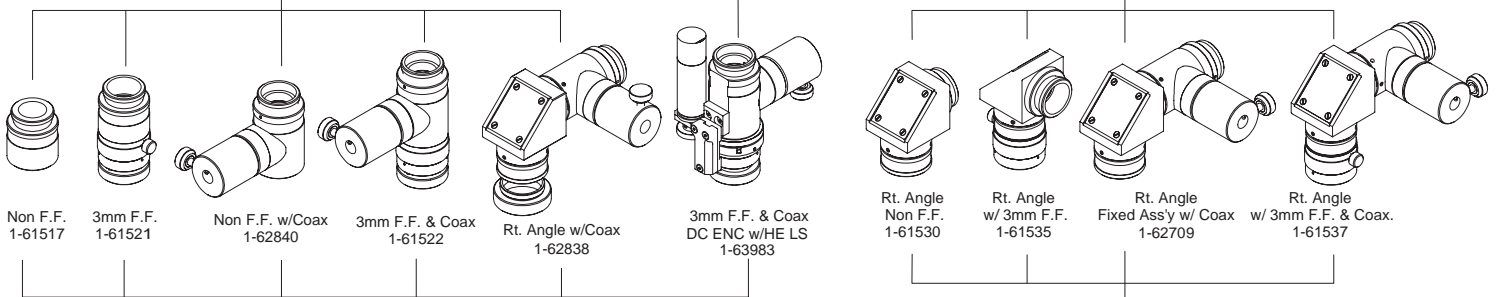

## Infinity Corrected Objectives

### Mitutoyo

### Motic

### Navitar

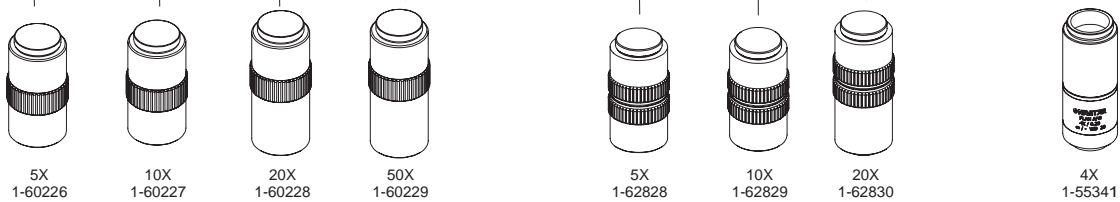

\* Included with ULTRA PRECISE EYE

\*\* Items are Special Order (Contact Navitar for Additional Information)

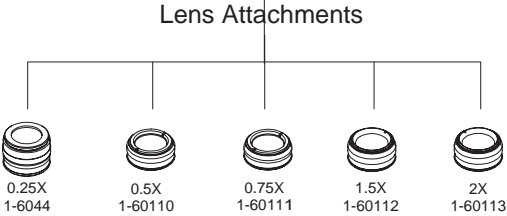
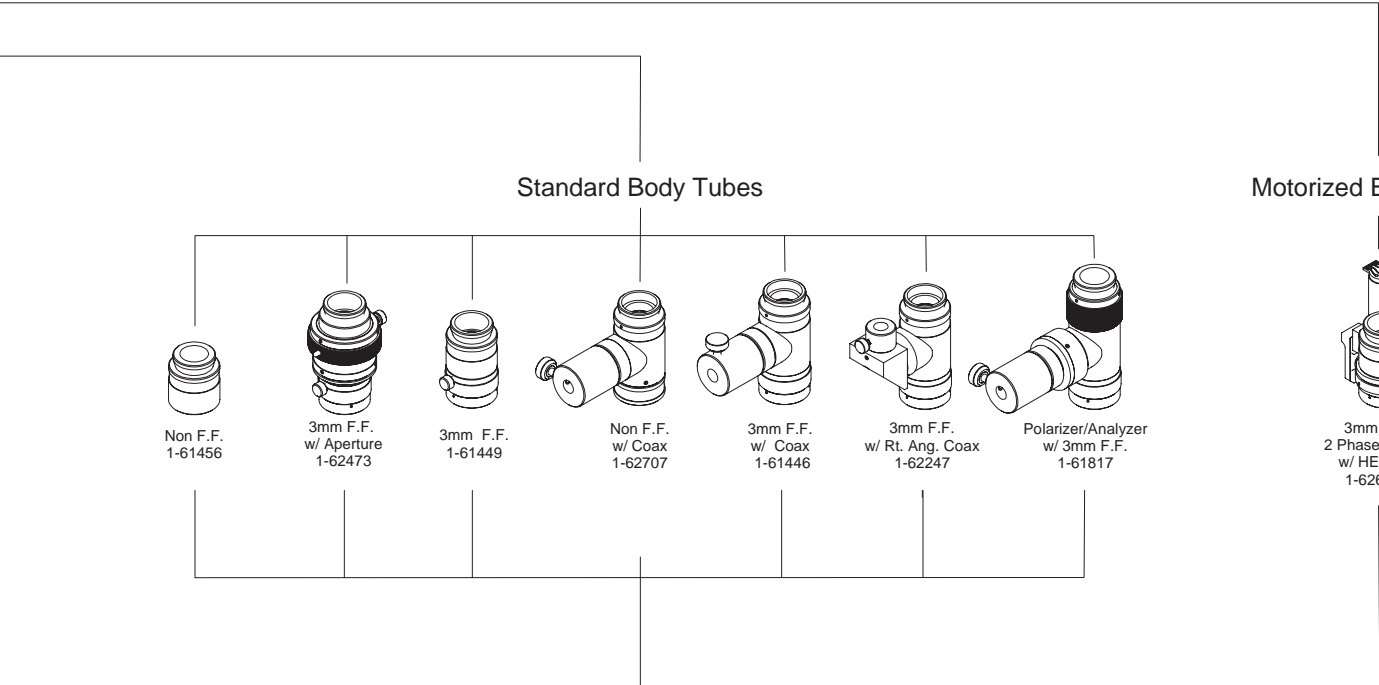
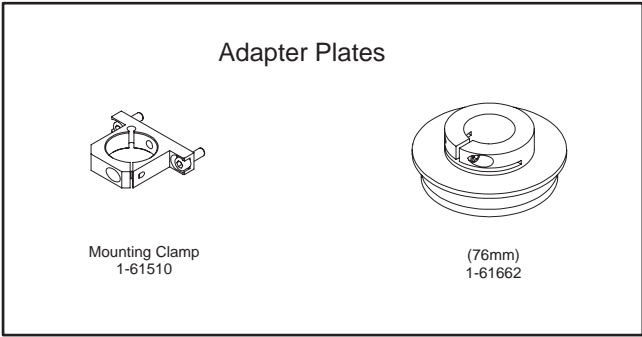

## High-Mag Microscopy Solution

The NUV-VIS Zoom is a motorized imaging lens system that operates within a spectral range of 330nm to 700nm and offers a 6.2:1 zoom ratio. It is an ideal digital imaging solution for high magnification microscopy and OEM applications such as protein crystallography, forensic evidence analysis and surface defect inspection.

- Designed for a 2/3" sensor
- Focal length range of 80-497mm
- Motorized for easy magnification adjustments
- Combine with infinity corrected imaging microscope objectives, Plan Apo NUV long working distance microscope objectives, and high power UV focusing objectives
- Operates within 330nm to 700nm spectral range
- Can be modified for manual actuation

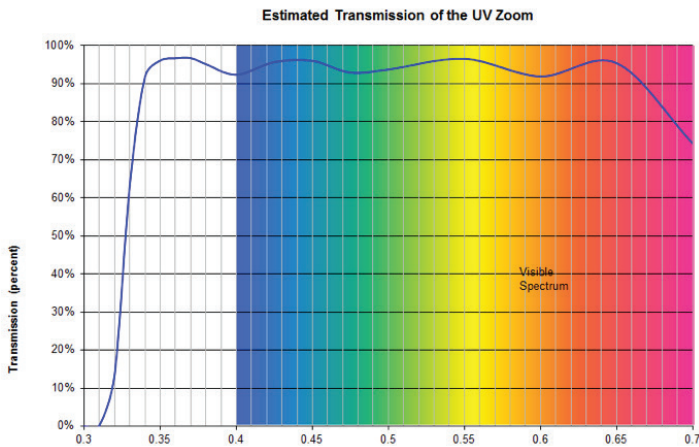

<b>Zoom Ratio:</b> 6.2:1
<b>Magnification:</b> 0.4x- 2.5x
<b>Focal Length Range:</b> 80 mm - 497 mm
<b>Spectral Range:</b> 330 nm - 700 nm
<b>NA: Image Side:</b> 0.019- 0.024
<b>Distortion:</b> < 0.2% across entire field
<b>Maximum Sensor Coverage:</b> 2/3"
<b>Camera Mount:</b> C-Mount
<b>Zoom Drive Mechanism:</b> 2 Phase Stepping Motor Hall-Effect Limit Sensors

Objective Lens (Mitutoyo) Plan Apo NUV	Working Distance	NA	Depth of Field	Camera Format	1.0X Adapter Low Mag H x V	1.0X Adapter High Mag H x V
<b>10X</b>	30.5 mm	0.28	6.4 μm	Mag	4.0X	24.9X
				1/4" Sensor	0.80 x 0.60	0.13 x 0.10
				1/3" Sensor	1.20 x 0.90	0.19 x 0.14
				1/2" Sensor	1.60 x 1.20	0.26 x 0.19
				2/3" Sensor	2.20 x 1.65	0.35 x 0.27
<b>20X</b>	17.0 mm	0.40	3.1 μm	Mag	8.0X	49.7X
				1/4" Sensor	0.40 x 0.30	0.06 x 0.05
				1/3" Sensor	0.60 x 0.45	0.10 x 0.07
				1/2" Sensor	0.80 x 0.60	0.13 x 0.10
				2/3" Sensor	1.10 x 0.83	0.18 x 0.13
<b>50X</b>	15.0 mm	0.42	0.8 μm	Mag	20.0X	124.3X
				1/4" Sensor	0.16 x 0.12	0.03 x 0.02
				1/3" Sensor	0.24 x 0.18	0.04 x 0.03
				1/2" Sensor	0.32 x 0.24	0.05 x 0.04
				2/3" Sensor	0.44 x 0.33	0.07 x 0.05

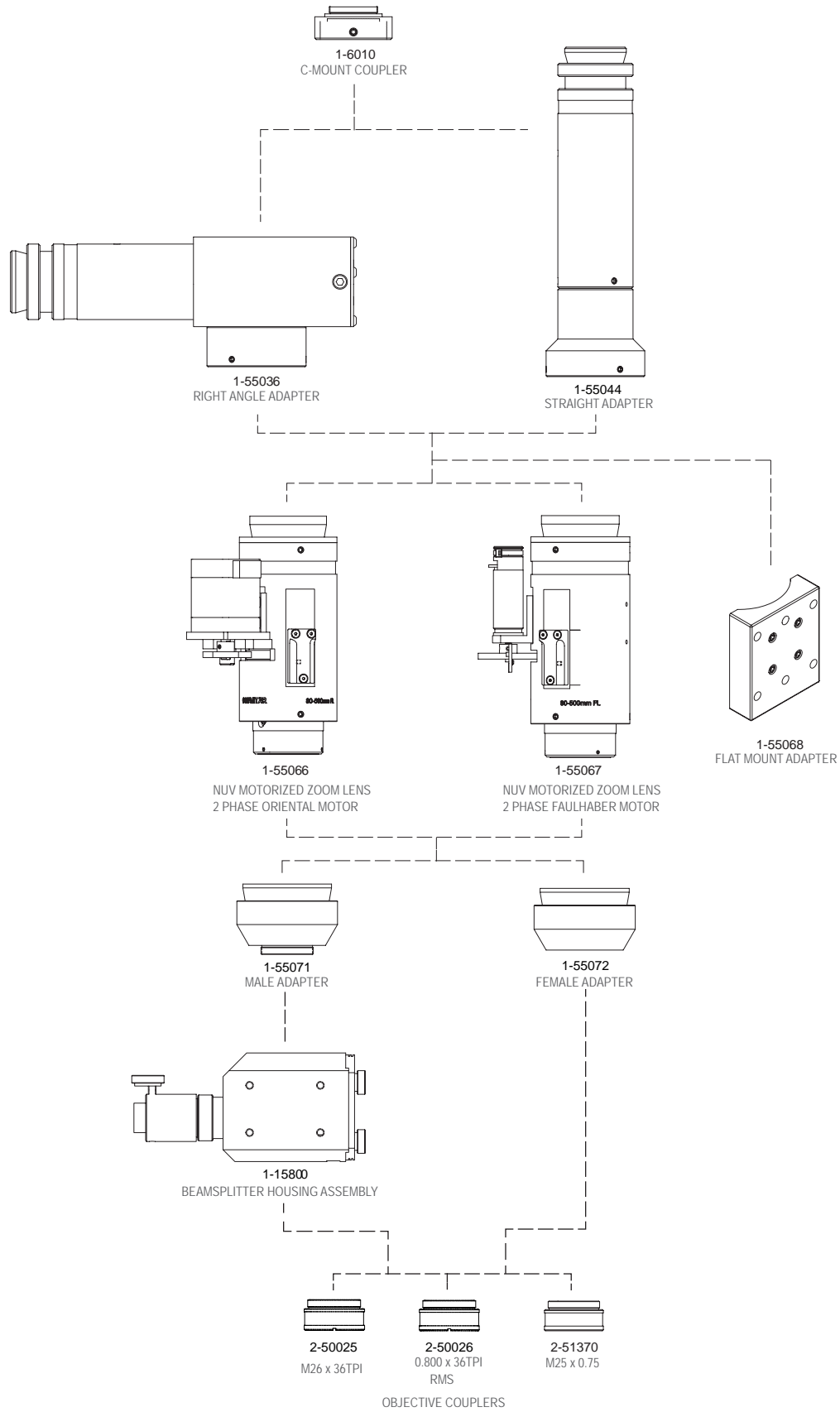

# DUAL VIEW LENS SYSTEM DIAGRAM

## Imaging Channel 1

An adapter tube will be needed for camera connection. We suggest using 1-6015 or 1-6218.

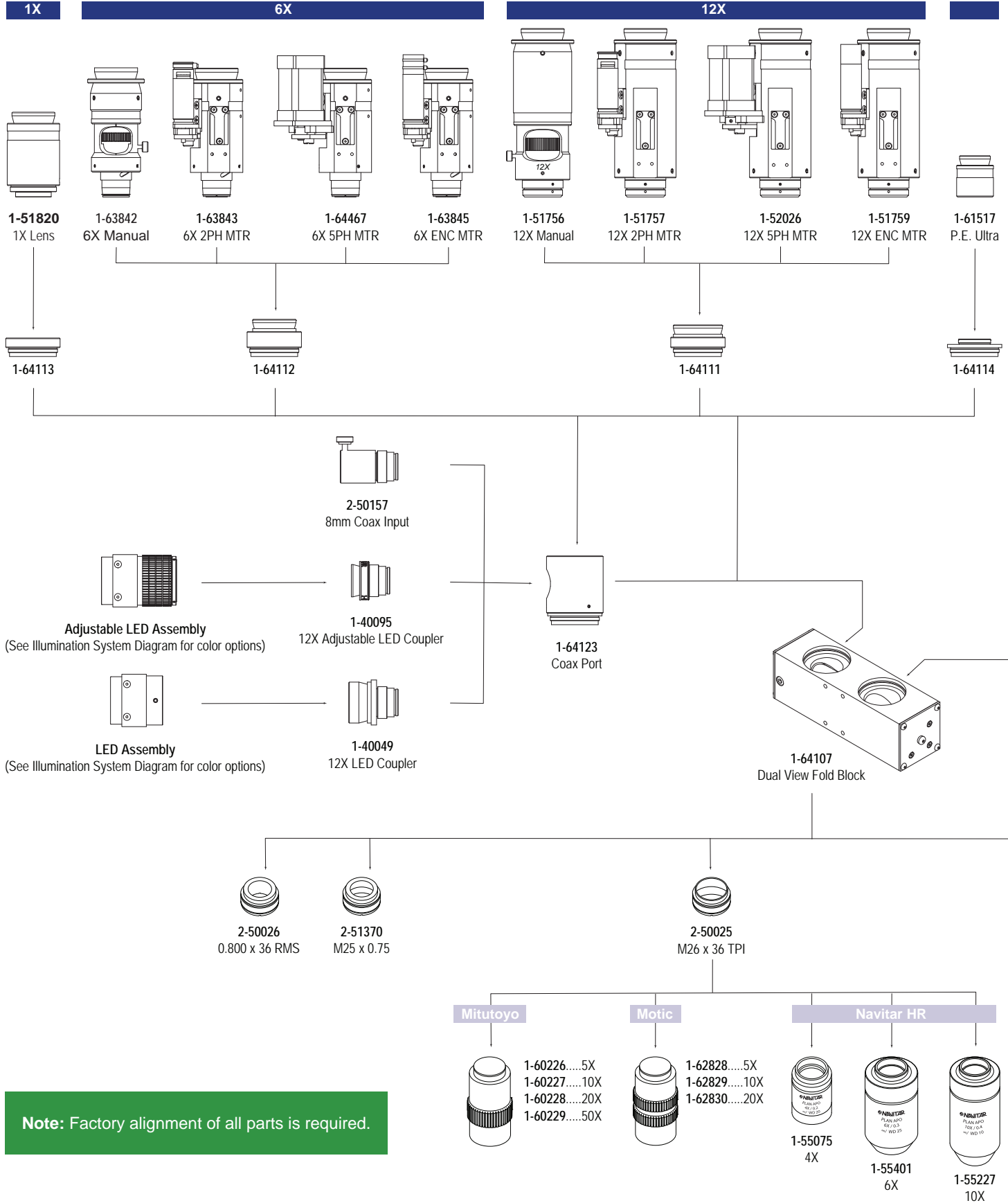





# MODULAR TUBE LENS SYSTEM DIAGRAM

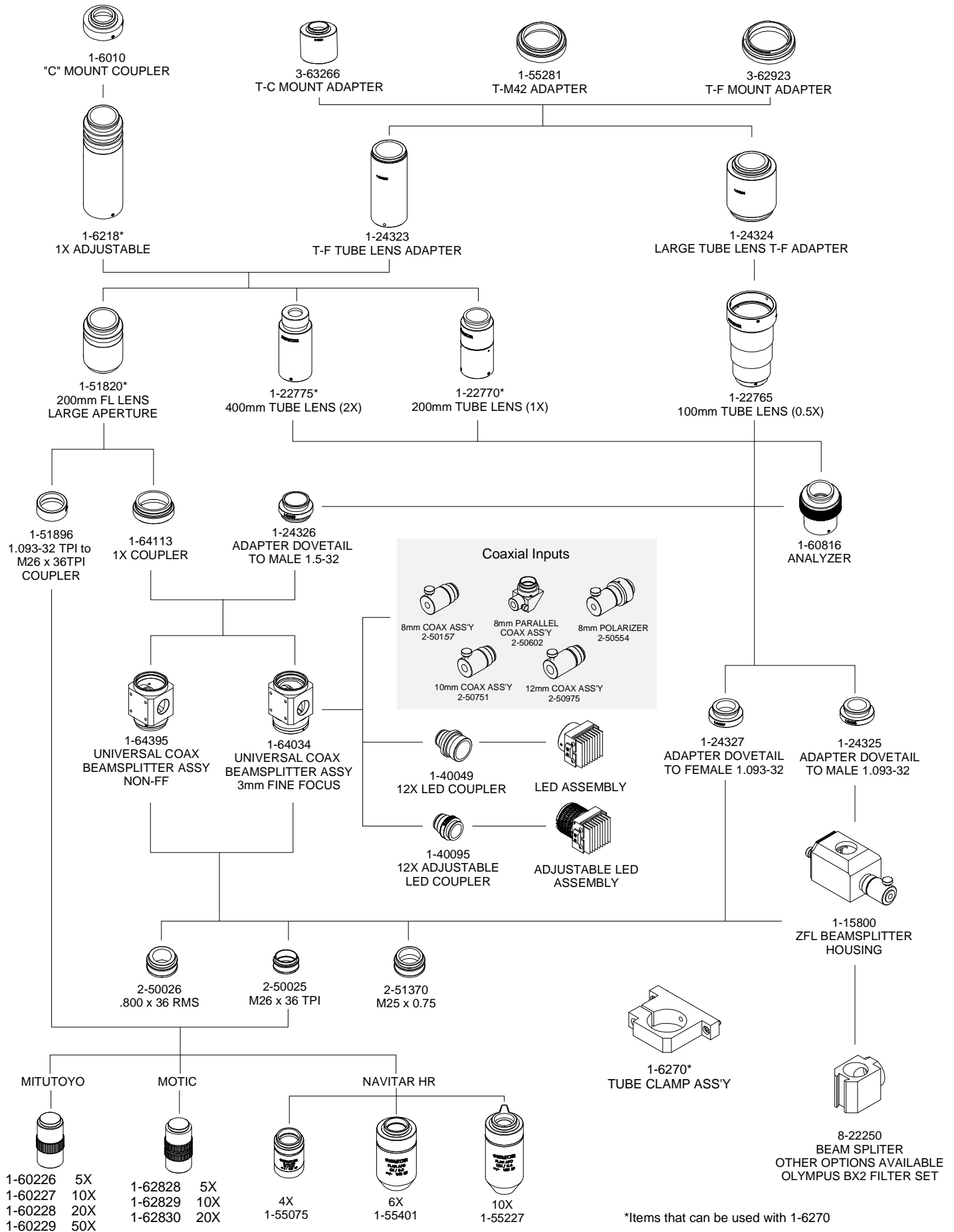

## Modular Tube Lens System

Navitar's new line of modular tube lenses offer the ideal optical solution for OEM and research imaging and measurement applications including metrology, flat panel inspection and cell imaging.

- 200mm focal length design for use with infinity corrected objectives
- 0.5x, 1x and 2x magnification modular tube lenses will cover camera sensors from 11-33mm
- 2 and 3 position objective changer available for using multiple objectives and magnifications
- Use with Brightfield, Transmitted, Reflected, and Köhler illumination techniques for high resolution images
- Perfect for industrial and life science applications



### MTL Field of View Matrix

Objective Lens	Working Distance	Camera Formats / Parameters	0.5X Tube Lens H x V	1.0X Tube Lens H x V	2.0X Tube Lens H x V
2X Navitar		2/3" Sensor	8.80 x 6.60	4.40 x 3.30	2.20 x 1.65
		1" Sensor	-	6.40 x 4.80	3.20 x 2.40
		4/3" Sensor	-	8.65 x 6.50	4.33 x 3.25
		33mm	-	-	6.60 x 4.95
4X Navitar	20 mm	2/3" Sensor	4.40 x 3.30	2.20 x 1.65	1.10 x 0.82
		1" Sensor	-	3.20 x 2.40	1.60 x 1.20
		4/3" Sensor	-	4.60 x 3.45	2.30 x 1.70
		33mm	-	-	3.30 x 2.40
5X Mitutoyo	34 mm	2/3" Sensor	3.52 x 2.64	1.76 x 1.32	0.88 x 0.66
		1" Sensor	-	2.56 x 1.92	1.28 x 0.96
		4/3" Sensor	-	3.46 x 2.60	1.73 x 1.30
		33mm	-	-	2.64 x 1.99
10X Mitutoyo	33.5 mm	2/3" Sensor	1.76 x 1.32	0.88 x 0.66	0.44 x 0.33
		1" Sensor	-	1.28 x 0.96	0.64 x 0.48
		4/3" Sensor	-	1.73 x 1.30	0.87 x 0.65
		33mm	-	-	1.32 x 0.99
20X Mitutoyo	20 mm	2/3" Sensor	0.88 x 0.66	0.44 x 0.33	0.22 x 0.16
		1" Sensor	-	0.64 x 0.48	0.32 x 0.24
		4/3" Sensor	-	0.87 x 0.65	0.43 x 0.32
		33mm	-	-	0.66 x 0.49
50X Mitutoyo	13 mm	2/3" Sensor	0.36 x 0.26	0.18 x 0.13	0.09 x 0.06
		1" Sensor	-	0.26 x 0.19	0.13 x 0.09
		4/3" Sensor	-	0.35 x 0.26	0.17 x 0.13
		33mm	-	-	0.26 x 0.19

Perfect for life science fluorescent imaging and industrial applications. Ask your sales representative for more details.

## High Resolution Plan Apochromat Infinity Corrected Objective Lenses



### Ideal for industrial and microscopy imaging applications.

Navitar HR plan apochromatic objectives offer high NA, large FOV, and working distances ranging from 10-39mm.

- Series includes 1X, 2X, 4X, 6X, 10X and 20X resolutions.
- Designed with a parfocal distance of 95mm to be compatible with turret applications.
- Apochromatic over 436-656 nm, providing excellent correction of spherical and chromatic aberrations.

Specification	High NA / Long W. D.		High NA / Large FOV			
	1X	2X	4X HR	6X HR	10X HR	20X HR
Part Numbers	1-55282	1-55273	1-55341	1-55401	1-55227	1-55354
Numerical Aperture	0.04	0.08	0.2	0.3	0.4	0.5
Working Distance	15 mm	39 mm	20 mm	25 mm	10 mm	10 mm
Focal Length	200 mm	100 mm	50 mm	33 mm	20 mm	10 mm
Resolving Power	8.96 $\mu\text{m}$	4.49 $\mu\text{m}$	3.45 $\mu\text{m}$	1.25 $\mu\text{m}$	0.97 $\mu\text{m}$	0.68 $\mu\text{m}$
Depth of Field $\pm$	$\pm 184 \mu\text{m}$	$\pm 46 \mu\text{m}$	$\pm 7.7 \mu\text{m}$	$\pm 3.5 \mu\text{m}$	$\pm 2.0 \mu\text{m}$	$\pm 1.0 \mu\text{m}$
Field Number	22	22	22	22	22	22
Compatible Tube Lens	EFL=200mm	EFL=200mm	EFL=200mm	EFL=200mm	EFL=200mm	EFL=200mm
Parfocal Length	95 mm	95 mm	95 mm	95 mm	95 mm	95 mm
Mounting Threads	M26 x 36 TPI	M26 x 36 TPI	M26 x 36 TPI	M26 x 36 TPI	M26 x 36 TPI	M26 x 36 TPI
Wavelength Range	436nm- 656nm	436nm- 656nm	436nm- 656nm	436nm- 656nm	436nm- 656nm	436nm- 656nm

### 4K HDR Lenses

Navitar offers compact, lightweight, HDR wide angle lenses designed for use with 12-16 Megapixel 1” format cameras with a 2.4um or 3.45um pixel pitch. The Centaur and Unicorn lenses are athermal over the operating temperature range and capable of day-night band operation 450nm to 850nm simultaneously.

- All glass construction
- Rectilinear distortion correction (Falcon Narrow & Dragon Narrow)
- F- $\theta$  distortion (Falcon & Unicorn)
- Telecentric
- Athermal operation
- Superior stray light rejection
- Optimized for HDR imaging applications
- Survival temperature range -40C to +70C
- Operating temperature range -20C to +50C



	Dragon Wide	Dragon Narrow	Falcon Wide	Falcon Narrow
Imager Format	1” (4K compatible)	1” (4K compatible)	1” (4K compatible)	1” (4K compatible)
Focal Length	9.50mm	17.75mm	7.10mm	18.75mm
F/#	1.8	1.8	2.4	2.8
Total Track Length (TTL)	125.0mm	125.0mm	55.0mm	55.0mm
Image Circle (nominal)	16.0mm	16.0mm	16.0mm	16.0mm
Field of View	96.5° diagonal	50.7° diagonal	112.0° diagonal	47.1° diagonal
Distortion (F-Theta / Rectilinear)	<0.5%	<2.4%	<0.5%	<1.0%
Relative Illumination	>85%	>80%	>85%	>80%
Resolution	On axis: >208lp/mm S&T Field Edge: > 208lp/mm S&T	On axis: >208lp/mm S&T Field Edge: > 208lp/mm S&T	On axis: >200lp/mm S&T Field Edge: > 140lp/mm S&T	On axis: >200lp/mm S&T Field Edge: > 200lp/mm S&T
Chief Ray Angle	<2° at 8.0mm image circle	<2° at 8.0mm image circle	<4° at 8.0mm image circle	<4° at 8.0mm image circle
IR Filter	Included	Included	Included	Included
Stray Light Rejection	< 1E10-4 (In-field) < 1E10-5 (Out-of-field)	< 1E10-4 (In-field) < 1E10-5 (Out-of-field)	< 1E10-4 (In-field) < 1E10-5 (Out-of-field)	< 1E10-4 (In-field) < 1E10-5 (Out-of-field)
Focus Stability	Athermal	Athermal	Athermal	Athermal

## Illumination Products

Navitar offers LED ring lights, Brightlight LED coaxial illuminators, fiber optic illuminators, and power supplies.

### Fiber Optic Lighting

These fiber optic illuminators consist of a Halogen illumination system with a variable light intensity control. They accept a single or dual light pipe or an attachable ring light for illuminating a wider area. These illuminators offer low operating temperature and low noise output.

Model	Description
1-6192	Ring light w/ 1.28" inside diameter, 0.5" input ferrule, 3 foot length (Also available in 6ft, 8ft, 10ft and 15ft lengths)
1-61214	Ring light w/ 1.28" inside diameter, 0.718" input ferrule, 3 foot length (Also available in 6ft and 8ft lengths)
1-60926	Ring light w/ 4.5" inside diameter, 0.718" input ferrule, 3 foot length
2-50017	Ring light adapter for any 12X with fine focus
1-60106	Flexible light pipe for co-axial, 0.5" input ferrule, 3 foot length (Also available in 6ft, 8ft, 10ft, 12ft and 15ft lengths)
1-60162	Flexible light pipe for co-axial, 0.718" input ferrule, 3 foot length (Also available in 6ft, 8ft and 12ft lengths)
1-6267	2" x 2" fiber optic back light, 0.718" input ferrule, 40" length
8-61313	Dual gooseneck, 0.718" input ferrule
1-60787	Coupler to convert 0.5" input ferrule to 0.718" input ferrule
EKE	Long-life replacement lamp; 200 hour life, 21V, 3250° K
EJV	Standard replacement lamp; 40 hour life, 21V, 3350° K

### Fiber Optics Power Supplies

Navitar offers a selection of compact, rugged, AC/DC Halogen light sources with solid state dimmers for variable light intensity and maximum lamp life.

Model	Description
8-61172	120 volt fiber optic power supply, 150w EKE lamp, 0.720" fiber receptacle (CSA, UL, CE compliant)
1-60563	220 volt fiber optic power supply, 150w EKE lamp, 0.720" fiber receptacle (CSA, UL, CE compliant)
8-61892	90-265 volt DC regulated fiber optic power supply, 150w EKE lamp, 0.720" fiber receptacle (CSA, UL, CE compliant)
1-63720	Light Source DC regulated 150W, 120/220V. CSA and CE certified.

### Internal Coaxial Input Ports

Zoom 6000	Description
2-60200	8 mm diameter fiber input
2-61503	10 mm diameter fiber input
2-61955	12 mm diameter fiber input
2-60263	8 mm diameter input parallel coaxial
1-60812	8 mm diameter input polarizer
12X Zoom	
2-50157	8 mm diameter fiber input
2-50751	10 mm diameter fiber input
2-50975	12 mm diameter fiber input
2-50602	8 mm diameter input parallel coaxial
1-50554	8 mm diameter input polarizer

## LED Illumination

Two LED based products are available from Navitar: Brightlight coaxial illuminators and Ring Light illuminators. Designed to match the optical performance of our vision systems, each illumination system was created to work with a specific system, such as Navitar's Zoom 6000, 12X Zoom or Precise Eye system. Each lighting component incorporates the correct number of individual LEDs, placed in the optimal optical position, to provide powerful, even illumination across a given field of view.

### Benefits Include:

- Longer life
- Minimum power loss
- Narrow wavelength band (red)
- Constant color temperature (white)
- Small packaging with optimal heat management
- No fan vibration
- Lower cost



Navitar can manufacture fiber bundles and ring lights in any length. Please contact Navitar directly with your specific requirements.

### Ring Light Systems

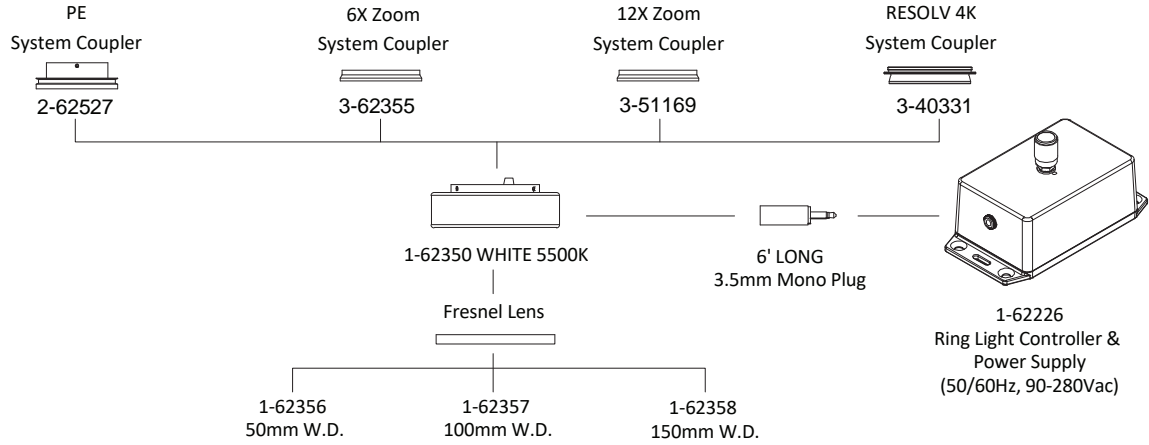

### Adjustable Coaxial LED Assemblies

**Illuminators:**

- 1-40086 Neutral White (4100K\*)
- 1-40087 Cool White (6500K\*)
- 1-40088 Warm White (3100K\*)
- 1-40089 Green (530nm\*)
- 1-40090 Cyan (505nm\*)
- 1-40091 Blue (470nm\*)
- 1-40092 Royal Blue (447.5nm\*)
- 1-40106 Red (627nm\*)
- 1-40093 Red-Orange (617nm\*)
- 1-40094 Amber (590nm\*)

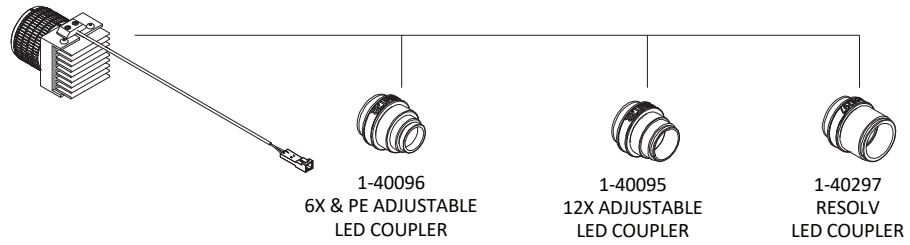

### Brightlight LED Assemblies

**Illuminators:**

- 1-40028 Neutral White (4100K\*)
- 1-40029 Cool White (6500K\*)
- 1-40030 Warm White (3100K\*)
- 1-40031 Green (530nm\*)
- 1-40032 Cyan (505nm\*)
- 1-40033 Blue (470nm\*)
- 1-40034 Royal Blue (447.5nm\*)
- 1-40035 Red (627nm\*)
- 1-40036 Red- Orange (617nm\*)
- 1-40037 Amber (590nm\*)

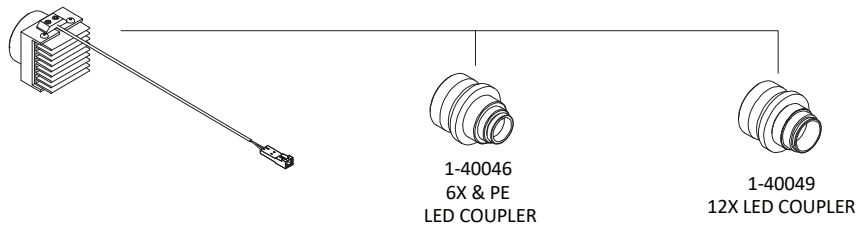

### Controllers

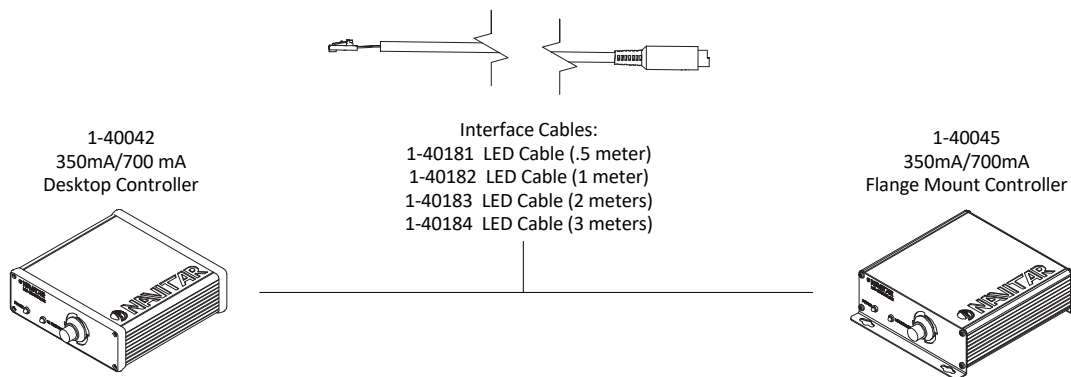

\*Values are typical. See website for tolerances\*  
 \*\*\* USB / RS-232 CABLES & POWER SUPPLY INCLUDED \*\*\*

## Large Format Lenses

Navitar's large format lenses, including brands like Kowa and Zeiss, meet the demands for high center to edge resolution, low distortion, and application specific F-numbers. These lenses are not modified video lenses; they are designed to match the performance abilities of high-end megapixel type cameras.

### Navitar 25mm Platinum Lens

Our innovative 25 mm multi-magnification lens (1-15838) works with F-mount or C-mount cameras and offers 200 line pairs per millimeter resolution. Ideal for vision system applications, this wide-angle lens is designed to allow cameras to inspect large areas without the great distance required by a typical lens.

Navitar's 25 mm lens features a fixed F/8 aperture which allows for a balance between depth of field and resolution while maintaining significant light-gathering power. It has 42 mm image coverage and a depth of field ranging from 15.4 mm at 0.1X to 1.1 mm at 0.5X. Its low distortion permits cameras to determine dimensional measurements without the need for software calibration on vision systems.



### 25 mm Platinum Lens Features

- Magnification from 0.1X to 0.5X
- Focusable from 2" to infinity
- 0.13% distortion on edges
- Wide field design for close-up imaging
- Large depth of field
- Diffraction limited
- Exceptional clarity and contrast

Part #	Mount	Image Diagonal	Focal Length (mm)	F/# Range	Minimum Operating Distance	Image Size at MOD		Filter Thread
						Width	Height	
1-15838	F/C-mount	42 mm	25	8 (fixed)	45 mm	68 mm	51 mm	none
1-18820	F-mount/M42	43 mm	50	2-22	500 mm	340 mm	250 mm	M 58x0.75
1-17494	—	90 mm	86	4-22	95 mm	72 mm	54 mm	M 55x0.75

### 25 mm Lens Magnification Specifications

Magnification	Object Size	Working Distance	Spot Size	Image MTF Cut-off	Object MTF Cut-off	Object NA	Image NA	Object Side Depth of Field
0.50X	85	45	6.5 $\mu$	140	70	0.0212	0.0425	1.1
0.34X	127	70	5.6 $\mu$	160	50	0.0159	0.0476	1.9
0.20X	212	120	5.2 $\mu$	190	38	0.0105	0.0526	4.5
0.14X	318	183	4.8 $\mu$	200	25	0.0074	0.0556	9.1
0.10X	424	245	4.8 $\mu$	200	20	0.0057	0.0572	15.4

\*Measurements are in millimeters unless otherwise specified.



## Zeiss Lenses

Zeiss ZF lenses offer the image quality associated with professional photography for technical and industrial applications. The ZF lenses are compatible with the Nikon F-Bayonet, the globally recognized standard for high-resolution industrial cameras with large format image sensors.

Zeiss ZF lenses feature manual focusing of the highest precision and the robust design. High image definition, color purity, stray light absorption, and excellent distortion correction.



	Part #	Mount	Image Diagonal	Focal Length	F/# Range	Minimum Operating Distance	Image Size at MOD		Filter Thread
							Width	Height	
Standard	1-18808	F-mount	43 mm	18 mm	3.5- 22	0.30	440 mm	290 mm	M 82x0.75
	1-18809	F-mount	43 mm	21 mm	2.8 - 22	0.22	190 mm	124 mm	M 82x0.75
	1-18810	F-mount	43 mm	25 mm	2.8 - 22	0.17	830 mm	550 mm	M 58x0.75
	1-18811	F-mount	43 mm	28 mm	2.0 - 22	0.24	170 mm	110 mm	M 58x0.75
	1-18812	F-mount	43 mm	35 mm	2.0 - 22	0.30	190 mm	130 mm	M 58x0.75
	1-18813	F-mount	43 mm	50 mm	1.4 - 16	0.45	240 mm	160 mm	M 58x0.75
	1-18814	F-mount	43 mm	50 mm	2.0 - 22	0.24	720 mm	480 mm	M 67x0.75
	1-18815	F-mount	43 mm	85 mm	1.4 - 16	1.00	360 mm	240 mm	M 72x0.75
	1-18816	F-mount	43 mm	100 mm	2.0 - 22	0.44	720 mm	480 mm	M 67x0.75

## Kowa Lenses

These large format lenses are optimized for machine vision, inspection, quality control, etc. Their rugged, compact design makes them ideal for demanding applications. Low distortion allows them to be used for close distance inspection and correspond to 4K line scan cameras.



	Part #	Mount	Image Diagonal	Focal Length	F/# Range	Minimum Operating Distance	Image Size at MOD		Filter Thread
							Width	Height	
Standard	1-19711	F-mount	43.3 mm	28 mm	2.8-16	0.30 m	388 mm	291 mm	M 72x0.75
	1-19712	F-mount	43.3 mm	35 mm	2.8-16	0.26 m	210 mm	158 mm	M 52x0.75
	1-19713	F-mount	43.3 mm	50 mm	2.8-16	0.26 m	135 mm	102 mm	M 52x0.75
3CCD	1-19908	F-mount	30.0 mm	28 mm	2.8-22	0.50 m	247 mm	185 mm	M 72x0.75
IR	1-19909	F-mount	43.3 mm	50 mm	1.9-16	0.50 m	269 mm	202 mm	M 52x0.75
4/3"	1-19910	C-mount	23.0 mm	12 mm	2.0-22	0.10 m	182 mm	136 mm	M 55x0.75
	1-19911	C-mount	23.0 mm	16 mm	2.0-22	0.10 m	135 mm	101 mm	M 40.5x0.5
	1-19912	C-mount	23.0 mm	25 mm	2.0-16	0.15 m	125 mm	93 mm	M 40.5x0.5
	1-19913	C-mount	23.0 mm	35 mm	2.0-16	0.20 m	100 mm	75 mm	M 37.5x0.5
	1-19914	C-mount	23.0 mm	50 mm	2.0-22	0.30 m	100 mm	75 mm	M 37.5x0.5

## Navitar Factory Automation Lenses

Navitar’s Machine Vision/ factory automation lenses are the benchmark for which all low magnification machine vision video lenses should be measured.

Quality all metal/glass construction coupled with precision engineering and manufacturing results in optically precise video lenses for your most demanding application. Short M.O.D.’s (minimum object distance) and compact design are ideally suited for your most challenging industrial and robotic image processing application.

Navitar offers a complete selection of machine vision quality video lenses from wide angle to telephoto, all with high resolution, low distortion and even illumination across the image plane of your camera.

### Lens formats include:

- 1.1” Format 12MP C-Mount Lenses
- 4/3” Format 8MP C-Mount Lenses
- 1” and 2/3” Format Megapixel C-Mount Lenses (up to 10MP)
- 1/2” Format High Resolution C-Mount Lenses
- SWIR 1” Format C-Mount Lenses (800nm to 1900nm)
- Large Format F-Mount Lenses (43.3mm diag.)
- Large Format F-Mount NIR Broad Band Coated Lens (400nm to 1200nm)

Manual focus and iris control with locking screws are standard on all lens models.

1.1” 12 MP C-Mount Fixed Focal Length Lenses							Compatible Pixelink Cameras	
Resolution (Center - Edge) 160 lp/mm - 100 lp/mm							PL-D7512 & PL-D7912	
Part Number	Focal Length	F-Stop	M.O.D.	Object Area at M.O.D. 1.1” (mm)	Object Area at M.O.D. 1” (mm)	Object Area at M.O.D. 2/3” (mm)	Lens Dimensions (mm)	Filter Diameter
NMV-6M1.1	6.5 mm	2.5- 16	0.1 m	256.0 x 190.0	231.0 x 172.0	157.0 x 117.0	84.0 x 79.1	Ø82 P=0.75
NMV-8M1.1	8.5 mm	2.5- 16	0.1 m	184.0 x 138.0	167.0 x 125.0	115.0 x 86.0	64.0 x 73.36	Ø62 P=0.75
NMV-12M1.1	12 mm	1.8- 16	0.1 m	135.0 x 101.0	123.0 x 92.0	84.0 x 63.0	54.0 x 73.8	Ø52 P=0.75
NMV-16M1.1	16 mm	1.8- 16	0.1 m	102.0 x 77.0	93.0 x 70.0	64.0 x 48.0	43.0 x 65.7	Ø35.5 P=0.5
NMV-25M1.1	25 mm	1.8- 16	0.1 m	64.0 x 48.0	58.0 x 44.0	40.0 x 30.0	45.0 x 69.4	Ø35.5 P=0.5
NMV-35M1.1	35 mm	1.8- 16	0.2 m	84.0 x 63.0	76.0 x 57.0	52.0 x 39.0	45.0 x 66.0	Ø40.5 P=0.5
NMV-50M1.1	50 mm	1.8- 16	0.2 m	59.0 x 44.0	54.0 x 40.0	37.0 x 28.0	45.0 x 74.5	Ø40.5 P=0.5

4/3” MP C-Mount Fixed Focal Length Lenses (23mm diag.)								
Resolution (Center - Edge) 160 lp/mm - 80 lp/mm								
Part Number	Focal Length	F-Stop	M.O.D.	Object Area at M.O.D. 1.1” (mm)	Object Area at M.O.D. 1” (mm)	Object Area at M.O.D. 2/3” (mm)	Lens Dimensions (mm)	Filter Diameter
1-24719	8 mm	2.8- 22	0.1 m	239.0 x 179.0	179.3 x 134.3	119.5 x 89.5	100 x 74	Ø72 P=0.75
1-19910	12 mm	2.0- 22	0.1 m	182.0 x 136.0	126.6 x 94.6	87.0 x 65.0	57 x 85	Ø55 P=0.75
1-19911	16 mm	2.0- 22	0.1 m	135.0 x 101.0	93.9 x 70.2	64.5 x 48.3	45 x 79.5	Ø40.5 P=0.5
1-19912	25 mm	2.0- 16	0.15 m	125.0 x 93.0	86.9 x 64.7	59.8 x 44.5	45 x 89	Ø40.5 P=0.5
1-19913	35 mm	2.0- 16	0.2 m	100.0 x 75.0	69.6 x 52.2	47.8 x 35.9	45 x 74	Ø37.5 P=0.5
1-19914	50 mm	2.0- 22	0.3 m	100.0 x 75.0	69.6 x 52.2	47.8 x 35.9	45 x 78	Ø37.5 P=0.5



1" MP C-Mount Fixed Focal Length Lenses							Compatible Pixelink Cameras		
Resolution (Center - Edge) 120 lp/mm - 80 lp/mm							PL-D759 & PL-D799		
Part Number	Focal Length	F-Stop	M.O.D.	Object Area at M.O.D. 1.1" (mm)	Object Area at M.O.D. 1" (mm)	Object Area at M.O.D. 2/3" (mm)	Lens Dimensions (mm)	Filter Diameter	
NMV-6M1	6 mm	1.8- 16	0.1 m	267.4 x 196.3	183.8 x 134.9	133.7 x 98.1	54 x 56.2	none	
NMV-8M1	8 mm	1.4- 16	0.1 m	147.0 x 110.5	101.2 x 75.9	73.6 x 55.2	57 x 58	Ø55 P=0.75	
NMV-12M1	12.5 mm	1.4- 16	0.3 m	307.5 x 230.5	211.2 x 158.4	153.6 x 115.2	42 x 52	Ø35.5 P=0.5	
NMV-16M1	16 mm	1.4- 16	0.3 m	227.0 x 170.5	156.2 x 117.1	113.6 x 85.2	42 x 52.9	Ø35.5 P=0.5	
NMV-25M1	25 mm	1.4- 16	0.3 m	140.8 x 105.6	96.8 x 72.6	70.4 x 52.8	42 x 43	Ø35.5 P=0.5	
NMV-35M1	35 mm	1.4- 16	0.3 m	96.9 x 72.7	66.6 x 50.0	48.5 x 36.4	42 x 43	Ø35.5 P=0.5	
NMV-50M1	50 mm	1.4- 16	0.5 m	115.2 x 86.4	79.2 x 59.4	57.6 x 43.1	47.5 x 48	Ø40.5 P=0.5	
NMV-75M1	75 mm	1.8- 16	1.0 m	157.9 x 118.4	108.6 x 81.4	78.9 x 59.2	48 x 57	Ø46 P=0.75	

2/3" 10 MP C-Mount Fixed Focal Length Lenses							Compatible Pixelink Cameras		
Resolution (Center - Edge) 200 lp/mm - 160 lp/mm							PL-D755 & PL-D795		
Part Number	Focal Length	F-Stop	M.O.D.	Object Area at M.O.D. 2/3" (mm)	Object Area at M.O.D. 1/2" (mm)	Object Area at M.O.D. 1/3" (mm)	Lens Dimensions (mm)	Filter Diameter	
1-19552	5 mm	1.8- 16	0.1 m	197.0 x 147.0	143.2 x 107.0	107.4 x 80.2	48 x 59.4	Ø46 P=0.75	
1-19553	8.5 mm	1.8- 22	0.1 m	133.2 x 99.6	96.9 x 72.4	72.7 x 54.3	36 x 56	Ø34 P=0.5	
1-19554	12 mm	1.8- 11	0.1 m	80.7 x 60.2	58.7 x 43.8	44.0 x 32.8	33 x 52.5	Ø25.5 P=0.5	
1-19555	16 mm	1.8- 16	0.1 m	61.1 x 45.7	44.4 x 33.2	33.2 x 24.9	33 x 47.5	Ø25.5 P=0.5	
1-19556	25 mm	1.8- 16	0.1 m	36.7 x 27.5	26.7 x 20.0	20.0 x 15.0	33 x 45.5	Ø25.5 P=0.5	
1-19557	35 mm	2.0- 16	0.1 m	23.4 x 17.6	17.0 x 12.8	12.8 x 9.6	43 x 49	Ø34 P=0.5	
1-19558	50 mm	2.8- 16	0.1 m	19.1 x 14.3	13.9 x 10.4	10.4 x 7.8	38 x 77	Ø30.5 P=0.5	

<b>2/3" 5 MP C-Mount Fixed Focal Length Lenses</b>							Compatible Pixelink Cameras PL-D755 & PL-D795	
Resolution (Center - Edge) 160lp/mm - 125 lp/mm								
Part Number	Focal Length	F-Stop	M.O.D.	Object Area at M.O.D. 2/3" (mm)	Object Area at M.O.D. 1/2" (mm)	Object Area at M.O.D. 1/3" (mm)	Lens Dimensions (mm)	Filter Diameter
1-24830	12.5 mm	1.4- 16	0.1 m	81.4 x 60.9	59.2 x 44.3	44.4 x 33.2	38.5 x 52.0	Ø30.5 P=0.5
1-24831	16 mm	1.4- 16	0.1 m	64.6 x 48.4	47.0 x 35.2	35.2 x 26.4	38.5 x 52.0	Ø30.5 P=0.5
1-24832	25 mm	1.6- 16	0.1 m	35.1 x 26.3	25.5 x 19.1	19.1 x 14.3	38.5 x 45.5	Ø30.5 P=0.5
1-24833	35 mm	1.6- 16	0.18 m	42.1 x 31.6	30.6 x 23.0	23.0 x 17.2	38.5 x 48.0	Ø30.5 P=0.5

<b>2/3" MP C-Mount Fixed Focal Length Lenses</b>							Compatible Pixelink Cameras PL-D753, PL-D755 & PL-D795	
Resolution (Center - Edge) 120lp/mm - 100 lp/mm								
Part Number	Focal Length	F-Stop	M.O.D.	Object Area at M.O.D. 2/3" (mm)	Object Area at M.O.D. 1/2" (mm)	Object Area at M.O.D. 1/3" (mm)	Lens Dimensions (mm)	Filter Diameter
NMV-5M23	5 mm	2.8- 16	0.05 m	196.8 x 147.6	110.0 x 105.0	82.0 x 78.0	42.0 x 38.7	Ø40.5 P=0.5
NMV-8M23	8 mm	1.4- close	0.12 m	117.3 x 88.0	84.0 x 63.0	63.0 x 47.0	34.0 x 41.6	Ø27 P=0.5
NMV-12M23	12 mm	1.4- close	0.15 m	110.0 x 82.5	79.0 x 59.0	59.0 x 44.0	34.0 x 37.0	Ø27 P=0.5
NMV-16M23	16 mm	1.4- 16	0.2 m	112.8 x 84.4	81.5 x 61.0	60.0 x 45.0	33.0 x 36.5	Ø27 P=0.5
NMV-25M23	25 mm	1.4- 16	0.2 m	71.1 x 53.3	51.0 x 38.0	38.0 x 28.0	33.0 x 39.5	Ø27 P=0.5
NMV-35M23	35 mm	2.0- 16	0.2 m	47.9 x 35.8	33.0 x 26.0	25.0 x 19.0	34.0 x 36.5	Ø27 P=0.5
NMV-50M23	50 mm	2.8- 22	0.2 m	29.3 x 21.9	21.0 x 16.0	16.0 x 12.0	34.0 x 55.0	Ø27 P=0.5
NMV-75M23	75 mm	2.5- 22	1.2 m	132 x 99	96.6 x 72.5			Ø34 P=0.5
NMV-100M23	100 mm	2.8- close	2.0 m	168.8 x 126.6	122.7 x 92.0			Ø40.5 P=0.5

<b>2/3" High Resolution C-Mount Fixed Focal Length Lenses</b>							Compatible Pixelink Cameras PL-D753 & PL-D752	
Resolution (Center - Edge) 100lp/mm - 60 lp/mm								
Part Number	Focal Length	F-Stop	M.O.D.	Object Area at M.O.D. 2/3" (mm)	Object Area at M.O.D. 1/2" (mm)	Object Area at M.O.D. 1/3" (mm)	Lens Dimensions (mm)	Filter Diameter
NMV-6	6 mm	1.4- 16	0.1 m	367 x 251	264 x 181	198 x 136	30 x 32.8	none
NMV-8	8 mm	1.4- 16	0.1 m	260 x 184	187 x 132	140 x 99	30 x 30	Ø27 P=0.5
NMV-12	12 mm	1.4- 16	0.1 m	237 x 173	170 x 125	127 x 93	30 x 31.5	Ø27 P=0.5
NMV-16	16 mm	1.4- 16	0.2 m	112 x 83	80 x 60	60 x 45	30 x 28	Ø27 P=0.5
NMV-25	25 mm	1.6- 16	0.2 m	119 x 89	86 x 64	64 x 48	30 x 28.5	Ø27 P=0.5
NMV-35	35 mm	1.6- 16	0.35 m	127 x 95	91 x 68	68 x 51	32 x 36.5	Ø30.5 P=0.5
NMV-50	50 mm	2.0- 22	0.5 m	85 x 64	61 x 46	46 x 34	32 x 39.5	Ø30.5 P=0.5

<b>1/2" High Resolution C-Mount Wide-Angle Fixed Focal Length Lenses</b>							Compatible Pixelink Cameras PL-D721 & PL-D721P	
Resolution (Center - Edge) 100 lp/mm - 60 lp/mm								
Part Number	Focal Length	F-Stop	M.O.D.	Object Area at M.O.D. 1/2" (mm)	Object Area at M.O.D. 1/3" (mm)	Object Area at M.O.D. 1/4" (mm)	Lens Dimensions (mm)	Filter Diameter
NMV-4WA	3.5	1.4- 16	0.2 m	396.0 x 247.0	297.0 x 185.0	198.0 x 123.0	31 x 30.5	none
NMV-5WA	4.5	1.4- 16	0.2 m	260.0 x 180.0	195.0 x 135.0	130.0 x 90.0	31 x 29.5	none
NMV-6WA	6	1.4- 16	0.2 m	174.0 x 128.0	130.0 x 96.0	87.0 x 64.0	31 x 34	Ø25.5 P=0.5
NMV-12WA	12	2.8- 32	0.3 m	167.0 x 123.0	125.0 x 92.0	83.0 x 61.0	31 x 29.5	Ø30.5 P=0.5

## Ruggedized Lenses

<b>1" C-Mount Fixed Focal Length Lenses</b> Resolution (Center - Edge) 120 lp/mm - 80 lp/mm							Compatible Pixelink Cameras PL-D759 & PL-D799	
Part Number	Focal Length	F-Stop	M.O.D.	Object Area at M.O.D. 1" (mm)	Object Area at M.O.D. 2/3" (mm)	Lens Dimensions (mm)	Filter Diameter	
1-26382	8 mm	F1.4 / F2.8 / F4 / F8	0.1 m	196 x 143	130 x 96	58 x 58	Ø55 P=0.75	
1-26383	12.5 mm	F1.4 / F2.8 / F4 / F8	0.3 m	330.6 x 243.5	222.4 x 165.2	44 x 51.5	Ø35.5 P=0.5	
1-26384	16 mm	F1.4 / F2.8 / F4 / F8	0.3 m	251.5 x 186.2	30.8 x 23.2	43 x 53	Ø35.5 P=0.5	
1-26385	25 mm	F1.4 / F2.8 / F4 / F8	0.3 m	160.7 x 119.2	20.2 x 15.1	43 x 43	Ø35.5 P=0.5	
1-26386	35 mm	F1.4 / F2.8 / F4 / F8	0.3 m	110.1 x 82	75.2 x 56.2	46 x 44	Ø35.5 P=0.5	
1-26387	50 mm	F1.4 / F2.8 / F4 / F8	0.5 m	121.8 x 91.3	83.8 x 62.9	50 x 48	Ø40.5 P=0.5	

<b>2/3" C-Mount Fixed Focal Length Lenses</b> Resolution (Center - Edge) 120 lp/mm - 100 lp/mm							Compatible Pixelink Cameras PL-D755 & PL-D795	
Part Number	Focal Length	F-Stop	M.O.D.	Object Area at M.O.D. 2/3" (mm)	Object Area at M.O.D. 1/2" (mm)	Lens Dimensions (mm)	Filter Diameter	
1-25551	8 mm	F1.4 / F4 / F8 / F16	0.1 m	56.5 x 43.9	42.6 x 32.5	33.0 x 41.6	Ø27 P=0.5	
1-25552	12 mm	F1.4 / F4 / F8 / F16	0.15 m	38.3 x 29.1	28.3 x 21.4	33.0 x 37.0	Ø27 P=0.5	
1-25553	16 mm	F1.4 / F4 / F8 / F16	0.2 m	30.0 x 22.7	21.8 x 16.4	33.0 x 36.5	Ø27 P=0.5	
1-25554	25 mm	F1.4 / F4 / F8 / F16	0.2 m	19.6 x 14.8	14.0 x 10.5	33.0 x 39.5	Ø27 P=0.5	
1-25555	35 mm	F1.6 / F4 / F8 / F16	0.2 m	14.4 x 10.8	10.5 x 7.9	33.0 x 37.8	Ø27 P=0.5	
1-25556	50 mm	F1.6 / F4 / F8 / F16	0.2 m	9.6 x 7.2	7.0 x 5.2	33.0 x 56.2	Ø27 P=0.5	

## SWIR Lenses

<b>SWIR 1" MP C-Mount Fixed Focal Length Lenses 800nm to 1900nm Transmission</b> Resolution (Center - Edge) 100 lp/mm - 60 lp/mm								
Part Number	Focal Length	F-Stop	M.O.D.	Object Area at M.O.D. 1/2" (mm)	Object Area at M.O.D. 1/3" (mm)	Object Area at M.O.D. 1/4" (mm)	Lens Dimensions (mm)	Filter Diameter
SWIR-8	8 mm	1.4- 16	0.1 m	147.0 x 110.5	101.2 x 75.9	73.6 x 55.2	57 x 58	Ø55 P=0.75
SWIR-12	12.5 mm	1.4- 16	0.3 m	307.5 x 230.5	211.2 x 158.4	153.6 x 115.2	43 x 51.5	Ø35.5 P=0.5
SWIR-16	16 mm	1.4- 16	0.3 m	227.0 x 170.5	156.2 x 117.1	113.6 x 85.2	43 x 52.9	Ø35.5 P=0.5
SWIR-25	25 mm	1.4- 16	0.4 m	192.0 x 144.0	132.0 x 99.0	96.0 x 72.0	43 x 43	Ø35.5 P=0.5
SWIR-35	35 mm	1.4- 16	0.4 m	133.5 x 100.1	91.8 x 68.8	66.7 x 50.0	43 x 43	Ø35.5 P=0.5
SWIR-50	50 mm	1.4- 16	0.6 m	140.8 x 105.6	96.8 x 72.6	70.4 x 52.8	49 x 48	Ø40.5 P=0.5

## Navitar Factory Automation Lenses

### Large Format 43.3mm Diagonal Sensor Coverage

F-Mount Fixed Focal Length Lenses					
Resolution (Center - Edge) 200 lp/mm - 63 lp/mm (M48 x 0.75 Mount – Call for More Info)					
Part #	Focal Length (mm)	F-Stop	M.O.D.	Lens Dimensions (mm)	Filter Diameter
1-19711	28	2.8 - 16	0.30 m	75 x 98	Ø72 P=0.75
1-19712	35	2.8 - 16	0.26 m	57.5 x 71	Ø52 P=0.75
1-19713	50	2.8 - 16	0.26 m	57.5 x 77	Ø52 P=0.75

F-Mount Fixed Focal Length Lens - NIR Broad Band Coated (400-1200nm)					
Resolution (Center - Edge) 160 lp/mm - 64 lp/mm (M42 x 1 P-Mount – Call for More Info)					
Part #	Focal Length (mm)	F-Stop	M.O.D.	Lens Dimensions (mm)	Filter Diameter
1-19909	50	1.9 - 16	0.5 m	58.5 x 105.2	Ø52 P=0.75

## Fujinon Factory Automation Lenses

### 1" Format Fixed Focal Length Lenses

Model	CF12.5HA-1	CF16HA-1	CF25HA-1	CF35HA-1	CF50HA-1	CF75HA-1
Focal Length	12.5 mm	16 mm	25 mm	35 mm	50 mm	75 mm
Iris Range/F-Stop	1.4- 22	1.4- 22	1.4- 22	1.4- 22	1.8- 22	1.8- 22
Iris Control	Manual	Manual	Manual	Manual	Manual	Manual
Focus Control	Manual	Manual	Manual	Manual	Manual	Manual
Min. Object Area 1"	120 mm x 90 mm	100 mm x 75 mm	65 mm x 48 mm	73 mm x 55 mm	76 mm x 57 mm	79 mm x 59 mm
Min. Object Area 1/2"	—	—	—	—	—	—
Focusing Range	0.1 m - ∞	0.1 m - ∞	0.1 m - ∞	0.2 m - ∞	0.4 m - ∞	0.9 m - ∞
Filter Diameter	Ø49 mm P=0.75	Ø49 mm P=0.75	Ø49 mm P=0.75	Ø49 mm P=0.75	Ø49 mm P=0.75	Ø49 mm P=0.75
Mount	C-Mount	C-Mount	C-Mount	C-Mount	C-Mount	C-Mount
Weight	280 g	280 g	300 g	190 g	200 g	300 g

### 2/3" Format Fixed Focal Length Lenses

Model	HF12.5SA-1	HF16SA-1	HF25SA-1	HF35SA-1	HF50SA-1	HF75SA-1
Focal Length	12.5 mm	16 mm	25 mm	35 mm	50 mm	75 mm
Iris Range/F-Stop	F1.4- F22	F1.4- F22	F1.4- F22	F1.4- F22	F1.8- F22	F1.8- F22
Iris Control	Manual	Manual	Manual	Manual	Manual	Manual
Focus Control	Manual	Manual	Manual	Manual	Manual	Manual
Min. Object Area 2/3"	83 mm x 62 mm	69 mm x 51 mm	44 mm x 33 mm	50 mm x 38 mm	70 mm x 52 mm	101 mm x 76 mm
Min. Object Area 1/2"	60 mm x 45 mm	50 mm x 37 mm	32 mm x 24 mm	37 mm x 27 mm	51 mm x 38 mm	74 mm x 55 mm
Min. Object Area 1/3"	45 mm x 34 mm	37 mm x 28 mm	24 mm x 18 mm	27 mm x 21 mm	38 mm x 28 mm	55 mm x 41 mm
Min. Object Area 1/4"	—	—	—	—	—	—
Focusing Range	0.1 m - ∞	0.1 m - ∞	0.1 m - ∞	0.2 m - ∞	0.2 m - ∞ *	0.9 m - ∞ **
Filter Diameter	Ø49 mm P=0.75	Ø49 mm P=0.75	Ø49 mm P=0.75	Ø49 mm P=0.75	Ø49 mm P=0.75	Ø49 mm P=0.75
Mount	C-Mount	C-Mount	C-Mount	C-Mount	C-Mount	C-Mount
Weight	295 g	285 g	315 g	185 g	240 g	300 g

## Fujinon Factory Automation Lenses

### 2/3" Format Fixed Focal Length Lenses

Model	HF8XA-1	HF12XA-1	HF16XA-1	HF25XA-1	HF35XA-1
Focal Length	8 mm	12 mm	16 mm	25 mm	35 mm
Iris Range/F-Stop	F1.6- F16	F1.6- F16	F1.6- F16	F1.6- F16	F1.9- F16
Iris Control	Manual	Manual	Manual	Manual	Manual
Focus Control	Manual	Manual	Manual	Manual	Manual
Min. Object Area 2/3"	106 mm x 80 mm	71 mm x 53 mm	55 mm x 42 mm	35 mm x 26 mm	50 mm x 38 mm
Min. Object Area 1/2"	77 mm x 58 mm	52 mm x 39 mm	40 mm x 30 mm	26 mm x 19 mm	36 mm x 27 mm
Min. Object Area 1/3"	58 mm x 43 mm	39 mm x 29 mm	30 mm x 23 mm	19 mm x 14 mm	27 mm x 20 mm
Focusing Range	0.1 m - ∞	0.1 m - ∞	0.1 m - ∞	0.1 m - ∞	0.2 m - ∞
Filter Diameter	∅25.5 mm P=0.50	∅25.5 mm P=0.50	∅25.5 mm P=0.50	∅25.5 mm P=0.50	∅25.5 mm P=0.50
Mount	C-Mount	C-Mount	C-Mount	C-Mount	C-Mount
Weight	79 g	79 g	71 g	72 g	60 g

Model	HF9HA-1S	HF12.5HA-1S	HF16HA-1S	HF25HA-1S	HF35HA-1S	HF50HA-1S	HF75HA-1S
Focal Length	9 mm	12.5 mm	16 mm	25 mm	35 mm	50 mm	75 mm
Iris Range/F-Stop	1.4- 16	1.4- 16	1.4- 16	1.4- 16	1.6- 22	2.3- 22	2.8- 22
Iris Control	Manual	Manual	Manual	Manual	Manual	Manual	Manual
Focus Control	Manual	Manual	Manual	Manual	Manual	Manual	Manual
Min. Object Area 2/3"	108 mm x 81 mm	78 mm x 58 mm	63 mm x 47 mm	53 mm x 40 mm	59 mm x 44 mm	77 mm x 57 mm	114 mm x 85 mm
Min. Object Area 1/2"	79 mm x 59 mm	57 mm x 42 mm	46 mm x 34 mm	38 mm x 29 mm	43 mm x 32 mm	56 mm x 42 mm	83 mm x 62 mm
Min. Object Area 1/3"	59 mm x 44 mm	42 mm x 32 mm	34 mm x 26 mm	29 mm x 22 mm	32 mm x 24 mm	42 mm x 31 mm	62 mm x 47 mm
Min. Object Area 1/4"	44 mm x 33 mm	32 mm x 24 mm	26 mm x 19 mm	22 mm x 16 mm	24 mm x 18 mm	31 mm x 24 mm	47 mm x 35 mm
Focusing Range	0.1 m - ∞	0.1 m - ∞	0.1 m - ∞	0.15 m - ∞	0.25 m - ∞ *	0.5 m - ∞	1.1 m - ∞
Filter Diameter	∅27 mm P=0.50	∅25.5 mm P=0.50	∅25.5 mm P=0.50	∅25.5 mm P=0.50	∅25.5 mm P=0.50	∅25.5 mm P=0.50	∅30.5 mm P=0.50
Mount	C-Mount	C-Mount	C-Mount	C-Mount	C-Mount	C-Mount	C-Mount
Weight	55 g	45 g	45 g	45 g	45 g	45 g	55 g

NOTES:

All Fujinon "HF" lenses come with focus and iris locking screws.

\* Using an extension tube longer than 5mm will increase the M.O.D. to 0.3m.

\*\* Using an extension tube longer than 5mm will increase the M.O.D. to 0.5m.

### 1/2" Format Fixed Focal Length Lenses

Model	DF6HA-1S*
Focal Length	6 mm
Iris Range/F-Stop	1.2- 16
Iris Control	Manual
Focus Control	Manual
Min. Object Area 1"	—
Min. Object Area 2/3"	—
Min. Object Area 1/2"	122 mm x 92 mm
Min. Object Area 1/3"	92 mm x 69 mm
Min. Object Area 1/4"	69 mm x 52 mm
Focusing Range	0.1 m - ∞
Filter Diameter	∅27 mm P=0.5
Mount	C-Mount
Weight	45 g

### 1/3" Format Fixed Focal Length Lenses for 3CCD Cameras

Model	TF2.8DA-8	TF4DA-8	TF15DA-8
Focal Length	2.8 mm	4 mm	15 mm
Iris Range/F-Stop	2.2- Close	2.2- Close	2.2- Close
Iris Control	Manual	Manual	Manual
Focus Control	Manual	Manual	Manual
Min. Object Area 1"	—	—	—
Min. Object Area 2/3"	—	—	—
Min. Object Area 1/2"	—	—	—
Min. Object Area 1/3"	218 mm x 153 mm	131 mm x 98 mm	36 mm x 27 mm
Min. Object Area 1/4"	145 mm x 102 mm	87 mm x 65 mm	24 mm x 18 mm
Focusing Range	0.1 m - ∞	0.1 m - ∞	0.1 m - ∞
Filter Diameter	No Filter Thread	∅27 mm P=0.5	∅25.5 mm P=0.5
Mount	C-Mount	C-Mount	C-Mount
Weight	75 g	70 g	60 g

## SWIR / Hyperspectral Lenses

Navitar’s fixed focal length SWIR/Hyperspectral lenses are specifically designed for SWIR (short wave infrared) cameras and applications. Lenses are available from 8mm to 50mm focal lengths. These lenses are ideal for a variety of imaging applications where SWIR cameras are employed such as perimeter surveillance, food sorting, toll-way monitoring, border and port security, quality control or aerial imaging.



Fixed Focal Length Models						
	SWIR-8	SWIR-12	SWIR-16	SWIR-25	SWIR-35	SWIR-50
Focal Length	8 mm	12.5 mm	16 mm	25 mm	35 mm	50 mm
Iris Range/F-Stop	1.4- 16	1.4- 16	1.4- 16	1.4- 16	1.4- 16	1.4- 16
Iris Control	Manual	Manual	Manual	Manual	Manual	Manual
Focus Control	Manual	Manual	Manual	Manual	Manual	Manual
Zoom Control	—	—	—	—	—	—
Min. Object Area 1”	147.0 mm x 110.5 mm	307.5 mm x 230.5 mm	227.0 mm x 170.5 mm	192.0 mm x 144.0 mm	133.5 mm x 100.1 mm	140.8 mm x 105.6 mm
Min. Object Area 2/3”	101.2 mm x 75.9 mm	211.2 mm x 158.4 mm	156.2 mm x 117.1 mm	132.0 mm x 99.0 mm	91.8 mm x 68.8 mm	96.8 mm x 72.6 mm
Min. Object Area 1/2”	73.6 mm x 55.2 mm	153.6 mm x 115.2 mm	113.6 mm x 85.2 mm	96.0 mm x 72.0 mm	66.7 mm x 50.0 mm	70.4 mm x 52.8 mm
Focusing Range	0.1 m - ∞	0.3 m - ∞	0.3 m - ∞	0.3 m - ∞	0.3 m - ∞	0.5 m - ∞
Filter Diameter	Ø55 mm P=0.75	Ø35.5 mm P=0.5	Ø35.5 mm P=0.5	Ø35.5 mm P=0.5	Ø35.5 mm P=0.5	Ø40.5 mm P=0.5
Mount	C-Mount	C-Mount	C-Mount	C-Mount	C-Mount	C-Mount
Weight	205	160	150	135	135	210

### Custom SWIR Lens Design Experience

Navitar offers custom-designed SWIR solutions and welcomes your project request. We have designed and built several custom lenses, including a system that detects visible near infrared (NIR) and short wave infrared (SWIR) wavelengths (500- 1600 nm). The custom design was a F/1.35, 25 mm, C-mount lens.

**Please contact your account manager for a custom SWIR quote today.**

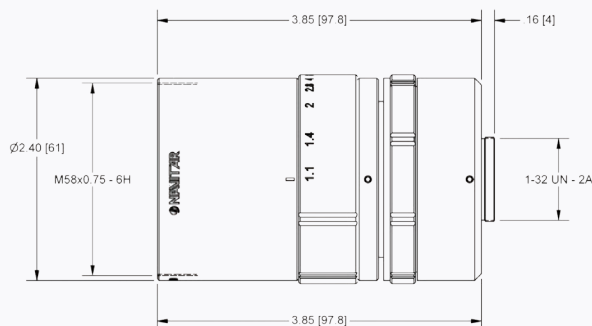



## Video Lens Accessories

### Extenders (for use with all lenses except SWIR)

A range extender, installed between the lens and camera, will extend the focal length and increase the effective aperture (F/number) of a video lens. For example, using the 2XE range extender will extend the focal length by two times (2X) and double the effective aperture of the following lens: (2X) 50 mm, F/1.3 lens = 100 mm F/2.6

### Extension Tube Kit

We also offer an extension tube kit, which allows you to turn standard fixed focal length lenses into macro lenses. The tube(s) mount between the camera and the lens, making it possible for you to focus a C-mount lens at a much closer distance.

### Available Accessories

Model	Description
HE15-1	1.5 X Extender, 13.08 mm long, Ø45
HE20-1	2.0X Extender, 13.74 mm long, Ø45
2XE	2.0X Extender, 11.12 mm long, Ø31.92
NMV-EXT	Extension Tube Kit, 5 pieces, 36.5mm total (0.5 mm, 1 mm, 5 mm, 10 mm, 20 mm)
3-6073	5 mm Extension Tube

## Converter Lens for Block Cameras

### Navitar Converter Lenses

Block cameras have long been used for numerous security, surveillance and industrial applications. Until recently, however, there were very few high quality converter lenses either to improve long-distance viewing or increase magnification.

Ideal for use in Unmanned Aerial Vehicles (UAVs), border security, and industrial automation, Navitar's converter lenses are compact and lightweight, and offer higher quality and a greater range of magnifications than those currently on the market.

### Technical Information

Navitar's converter lenses easily interface with block cameras to provide optimal zoom ranges. Relative illumination ranges from 50% to 88%. Part numbers and descriptions may be found below. For outline drawings and specifications detailing optical performance and FOV changes, visit [navitar.com](http://navitar.com)

Part Number	Description
1-19271	2X Teleconverter Lens

### Mounting Options

Navitar recognizes that each customer's application is unique. Our design team will work closely with each user to develop the best mounting option for your specific project.

### Camera Testing

Navitar has tested several cameras with the converter lenses, including Sony's FCB-980S, FCB-EX1000, FCB-H10, FCB-H11, and FCB-EX1020.

With the vast number of camera product offerings available, we will arrange for a lens to be sent to your company for testing.

**Designs exist for magnifications ranging from 4X to 0.4X. Please call for more information.**



**PL-X Series**

**High Performance 10 GigE Machine Vision Cameras**

- 10X Faster Than GigE & 2X Faster Than USB3
- Larger Bandwidth for High-Speed Imaging
- 10GBase-T Interface
- Power Over Ethernet (PoE)
- Trigger Over Ethernet (ToE)
- Reliable up to 100m Over CAT6A



**1.1" & 1.2" Sensors**

Model	Resolution	Sensor Diagonal	Pixel Pitch	Sensor	Sensor Size	Frame Rate	Color Space	Bit Depth	Mount Option	Shutter Type
<b>PL-X9512</b>	12 MP (4096 x 3000)	17.6 mm	3.45 µm	Sony IMX253	1.1"	65 fps	C - M	12	C	Global
<b>PL-X957</b>	7 MP (3216 x 2200)	17.6 mm	4.5 µm	Sony IMX420	1.1"	154 fps	C - M	12	C	Global
<b>PL-X9520</b>	20 MP (4512 x 4512)	17.5 mm	2.74 µm	Sony IMX531	1.1"	52 fps	C - M	12	C	Global
<b>PL-X9524</b>	24 MP (5328 x 4608)	19.3 mm	2.74 µm	Sony IMX530	1.2"	44 fps	C - M	12	TFL - C	Global

**PL-D Series**

**High Performance USB 3.0 Machine Vision Cameras**

- Resolutions up to 20 Megapixels
- Wide Range of CMOS Image Sensors
- Fast Frame Rates
- Low Noise Images



**1.1" & 1.2" Sensors**

Model	Resolution	Sensor Diagonal	Pixel Pitch	Sensor	Sensor Size	Frame Rate	Color Space	Bit Depth	Mount Option	Shutter Type
<b>PL-D7920</b>	20 MP (4512 x 4512)	17.5 mm	2.74 µm	Sony IMX541	1.1"	21 fps	C - M	12	C - CS	Global
<b>PL-D7512</b>	12 MP (4096 x 3000)	17.6 mm	3.45 µm	Sony IMX253	1.1"	33 fps	C - M	12	C - CS	Global
<b>PL-D7912</b>	12 MP (4096 x 3000)	17.6 mm	3.45 µm	Sony IMX304	1.1"	23 fps	C - M	12	C - CS	Global
<b>PL-D757 (HDR)</b>	7 MP (3208 x 2200)	17.6 mm	4.5 µm	Sony IMX420	1.1"	57 fps	C - M	12	C - CS	Global
<b>PL-D797</b>	7 MP (3208 x 2200)	17.6 mm	4.5 µm	Sony IMX428	1.1"	27 fps	C - M	12	C - CS	Global
<b>PL-D7924</b>	24 MP (5328 x 4608)	19.3 mm	2.74 µm	Sony IMX540	1.2"	17 fps	C - M	12	C - CS	Global

**1" Sensors**

Model	Resolution	Sensor Diagonal	Pixel Pitch	Sensor	Frame Rate	Color Space	Bit Depth	Mount Option	Shutter Type
<b>PL-D7620</b>	20 MP (5472 x 3648)	15.9 mm	2.4 µm	Sony IMX183	20 fps	C or M	12	C or CS	Rolling
<b>PL-D759</b>	9 MP (4096 x 2160)	16.1 mm	3.45 µm	Sony IMX255	45 fps	C or M	12	C or CS	Global
<b>PL-D799</b>	9 MP (4096 x 2160)	16.1 mm	3.45 µm	Sony IMX267	32 fps	C or M	12	C or CS	Global
<b>PL-D726</b>	7 MP (2208 x 3000)	13.0 mm	3.5 µm	onsemi IBIS4	5 fps	M	10	C	Rolling
<b>PL-D725</b>	5 MP (2592 x 2048)	15.9 mm	4.8 µm	onsemi Vita5000	75 fps	C or M	10	C or CS	Global
<b>PL-D734</b>	4 MP (2048 x 2048)	15.9 mm	5.5 µm	CMOSIS CMV4000	90 fps	C or M or NIR	10	C or CS	Global

**1 / 1.2" Sensors**

Model	Resolution	Sensor Diagonal	Pixel Pitch	Sensor	Frame Rate	Color Space	Bit Depth	Mount Option	Shutter Type
<b>PL-D752</b>	2 MP (1920 x 1200)	13.4 mm	5.86 µm	Sony IMX174	167 fps	C or M	12	C or CS	Global

**2 / 3" Sensors**

Model	Resolution	Sensor Diagonal	Pixel Pitch	Sensor	Frame Rate	Color Space	Bit Depth	Mount Option	Shutter Type
<b>PL-D755MU-POL (Polarized)</b>	5 MP (2448 x 2048)	11.1 mm	3.45 µm	Sony IMX250MZR	36 fps	M	12	C	Global
<b>PL-D755</b>	5 MP (2448 x 2048)	11.1 mm	3.45 µm	Sony IMX250	80 fps	C - M	12	C - S - CS	Global
<b>PL-D795</b>	5 MP (2448 x 2048)	11.1 mm	3.45 µm	Sony IMX264	36 fps	C - M	12	C - S - CS	Global
<b>PL-D753 (HDR)</b>	3 MP (1936 x 1464)	11.0 mm	4.5 µm	Sony IMX421	141 fps	C - M	12	C - S - CS	Global
<b>PL-D732</b>	2 MP (2048 x 1088)	12.7 mm	5.5 µm	CMOSIS CMV2000	170 fps	C - M - NIR	10	C - S - CS	Global
<b>PL-D722</b>	2 MP (1920 x 1200)	10.9 mm	4.8 µm	onsemi Vita 2000	87 fps	C - M	10	C - S - CS	Global

**1 / 2" Sensors**

Model	Resolution	Sensor Diagonal	Pixel Pitch	Sensor	Frame Rate	Color Space	Bit Depth	Mount Option	Shutter Type
<b>PL-D721P</b>	1 MP (1280 x 1024)	7.9 mm	4.8 µm	onsemi Python 1300	212 fps	M	10	C - S - CS	Global
<b>PL-D721</b>	1 MP (1280 x 1024)	7.9 mm	4.8 µm	onsemi Vita 1300	151 fps	C - M	10	C - S - CS	Global

**1 / 2.3" Sensors**

Model	Resolution	Sensor Diagonal	Pixel Pitch	Sensor	Frame Rate	Color Space	Bit Depth	Mount Option	Shutter Type
<b>PL-D7718</b>	18 MP (4912 x 3680)	7.67 mm	1.25 µm	onsemi AR1820	14 fps	C	12	C - S - CS	Rolling
<b>PL-D7715</b>	15 MP (4608x3288)	7.9 mm	1.4 µm	onsemi MT9F002	13 fps	C	12	C - S - CS	Rolling

**1 / 2.3" Sensors**

Model	Resolution	Sensor Diagonal	Pixel Pitch	Sensor	Frame Rate	Color Space	Bit Depth	Mount Option	Shutter Type
<b>PL-D775</b>	5 MP (2592 x 1944)	7.1 mm	2.2 µm	onsemi MT9P006	14 fps	C - M	12	C - S - CS	Rolling



## Autofocus Systems

Fast, Durable Autofocus Cameras

- One-Push Autofocus
- Fully Integrated Liquid Lens
- Near Infinite Focal Range
- On-Camera Focus Processing
- Seamless Integration with Pixelink SDK



### Extensive Optical Variation

Displacing a liquid interface allows for larger phase shift variations.

### Rugged Design

Our lenses have been tested for over 100 million cycles showing zero performance degradation. They show excellent response before and after shock tests.

### Extreme Speed

Refocus in less than 20 milliseconds.

### Low Power Consumption

Our liquid lens consumes 15mW, a tenth of what other systems require.

### By Sensor Size

Model	Sensor Size	Resolution	Sensor Diagonal	Pixel Pitch	Sensor	Frame Rate	Color Space	Bit Depth	Mount Option	Shutter Type
PL-D755AF	2/3"	5 MP (2448 x 2048)	11.1 mm	3.45 µm	Sony IMX250	80 fps	C - M	12	C - S	Global
PL-D753AF (HDR)	2/3"	3 MP (1936 x 1464)	11.0 mm	4.5 µm	Sony IMX421	141 fps	C - M	12	C - S	Global
PL-D732AF	2/3"	2 MP (2048 x 1088)	12.7 mm	5.5 µm	CMOS CMV2000	170 fps	C - M - NIR	10	C - S	Global
PL-D722AF	2/3"	2 MP (1920 x 1200)	11.0 mm	4.8 µm	onsemi Vita 2000	87 fps	C - M	10	C - S	Global
PL-D721AF	1/2"	1 MP (1280 x 1024)	7.9 mm	4.8 µm	onsemi Vita 1300	151 fps	C - M	10	C - S	Global
PL-D7718AF	1/2.3"	18 MP (4912 x 3680)	7.67 mm	1.25 µm	onsemi AR1820	14 fps	C	12	C - S	Rolling
PL-D775AF	1/2.5"	5 MP (2592 x 1944)	7.1 mm	2.2 µm	onsemi MT9P006/P031	14 fps	C - M	12	C - S	Rolling
PL-D7620AF	1"	20 MP (5472 x 3648)	15.9 mm	2.4 µm	Sony IMX183	20 fps	C - M	12	C - S	Rolling

### Liquid Lens Specifications

	Varioptic C-Mount		Edmund Optics Liquid Lens Cx Series				Varioptic S-Mount			Edmund Optics Liquid Lens S-Mount			
EFL	16 mm	25 mm	12 mm	16 mm	25 mm	35 mm	2.6 mm	7.5 mm	9.6 mm	6 mm	8 mm	12 mm	16 mm
Format	1/3" - 2/3"	1/3" - 2/3"	1/2"	2/3"	2/3"	2/3"	1/2.5"	1/4" - 1/2.5"	1/4" - 1/1.8"	1/2"	1/2"	1/2"	1/1.8"
F#	f/2.8	f/4-22	f/6	f/5	f/5	f/7	f/2.5	f/2.9	f/3.7	f/2.4	f/2.4	f/2.4	f/2.4
Focus Range	110 mm	120 mm	100 mm	100 mm	150 mm	225 mm	4 mm	70 mm	70 mm	100 mm	150 mm	150 mm	220 mm
	to Infinity		to Infinity				to Infinity			to Infinity			

**M Series**

High Performance Microscopy Cameras

- High-Resolution Imaging for Laboratory Use
- Ideal for Bright Field and Dark Field Microscopy
- High Quality Image Acquisition
- Excellent Color Reproduction
- 1 Megapixel to 20 Megapixel Resolutions
- µScope Microscopy Software Suite Available



**1.1" Sensors**

Model	Resolution	Sensor Diagonal	Pixel Pitch	Sensor	Frame Rate	Color Space	Bit Depth	Mount Option	Shutter Type
<b>M12-CYL</b>	12 MP (4096 x 3000)	17.6 mm	3.45 µm	Sony IMX253	33 fps	C - M	12	C	Global
<b>M12B-CYL</b>	12 MP (4096 x 3000)	17.6 mm	3.45 µm	Sony IMX304	23 fps	C - M	12	C	Global
<b>M7-CYL</b>	7 MP (3208 x 2200)	17.6 mm	4.5 µm	Sony IMX420	57 fps	C - M	12	C	Global

**1" Sensors**

Model	Resolution	Sensor Diagonal	Pixel Pitch	Sensor	Frame Rate	Color Space	Bit Depth	Mount Option	Shutter Type
<b>M20-CYL</b>	20 MP (5472 x 3648)	15.9 mm	2.4 µm	Sony IMX183	20 fps	C - M	12	C	Rolling
<b>M9-CYL</b>	9 MP (4096 x 2160)	16.1 mm	3.45 µm	Sony IMX255	45 fps	C - M	12	C	Global
<b>M4-CYL</b>	4 MP (2048 x 2048)	15.9 mm	5.5 µm	CMOSIS CMV4000	90 fps	C - M	10	C	Global
<b>M5-CYL</b>	5 MP (2592 x 2048)	15.9 mm	4.8 µm	onsemi Vita 5000	75 fps	C - M	10	C	Global

**2/3" Sensors**

Model	Resolution	Sensor Diagonal	Pixel Pitch	Sensor	Frame Rate	Color Space	Bit Depth	Mount Option	Shutter Type
<b>M5D-CYL</b>	5 MP (2448 x 2048)	11.1 mm	3.45 µm	Sony IMX250	80 fps	C - M	12	C	Global
<b>M3-CYL</b>	3 MP (1936 x 1464)	11 mm	4.5 µm	Sony IMX421	141 fps	C - M	12	C	Global
<b>M2-CYL</b>	2 MP (2048 x 1088)	12.7 mm	5.5 µm	CMOSIS CMV2000	170 fps	C - M	10	C	Global

**1/2" Sensors**

Model	Resolution	Sensor Diagonal	Pixel Pitch	Sensor	Frame Rate	Color Space	Bit Depth	Mount Option	Shutter Type
<b>M1-CYL</b>	1 MP (1280 x 1024)	7.9 mm	4.8 µm	onsemi Vita 1300	151 fps	C / M	10	C	Global

**1/2.3" Sensors**

Model	Resolution	Sensor Diagonal	Pixel Pitch	Sensor	Frame Rate	Color Space	Bit Depth	Mount Option	Shutter Type
<b>M18-CYL</b>	18 MP (4912 x 3680)	7.67 mm	1.25 µm	onsemi AR1820	14 fps	C	12	C	Rolling



Pixelink Capture

- Captures Images and Video
- Real-Time Video Streaming
- Full Control of All Camera Features
- Control of Trigger and GPIO Functions
- Resizable Region of Interest (ROI)
- Customizable Multi-Camera View
- Integrated Zoom and Focus Control
- Measurement Export In Excel Format
- Autofocus for Navitar, Varioptic and Edmund Lenses
- Accurate Measurement of Dimensions and Pixel Location

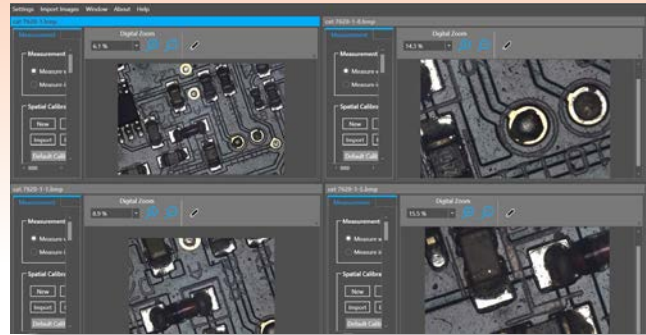

Four Camera Layout

**Pixelink Capture** is a real-time, interactive, image preview and acquisition program included with all Pixelink cameras. Users have the ability to adjust all camera features, including region of interest, frame rate, exposure, gain, and color, through an easy to use GUI, prior to image or video clip capture. The multi-window environment includes a preview window, a configuration window, and a real-time histogram, that can be displayed for up to four cameras at a time. The program also includes built-in measurement tools and autofocus applications.

Pixelink Capture offers tremendous flexibility and power, providing the ability to configure and run a single camera, or multi-camera, vision application seamlessly.

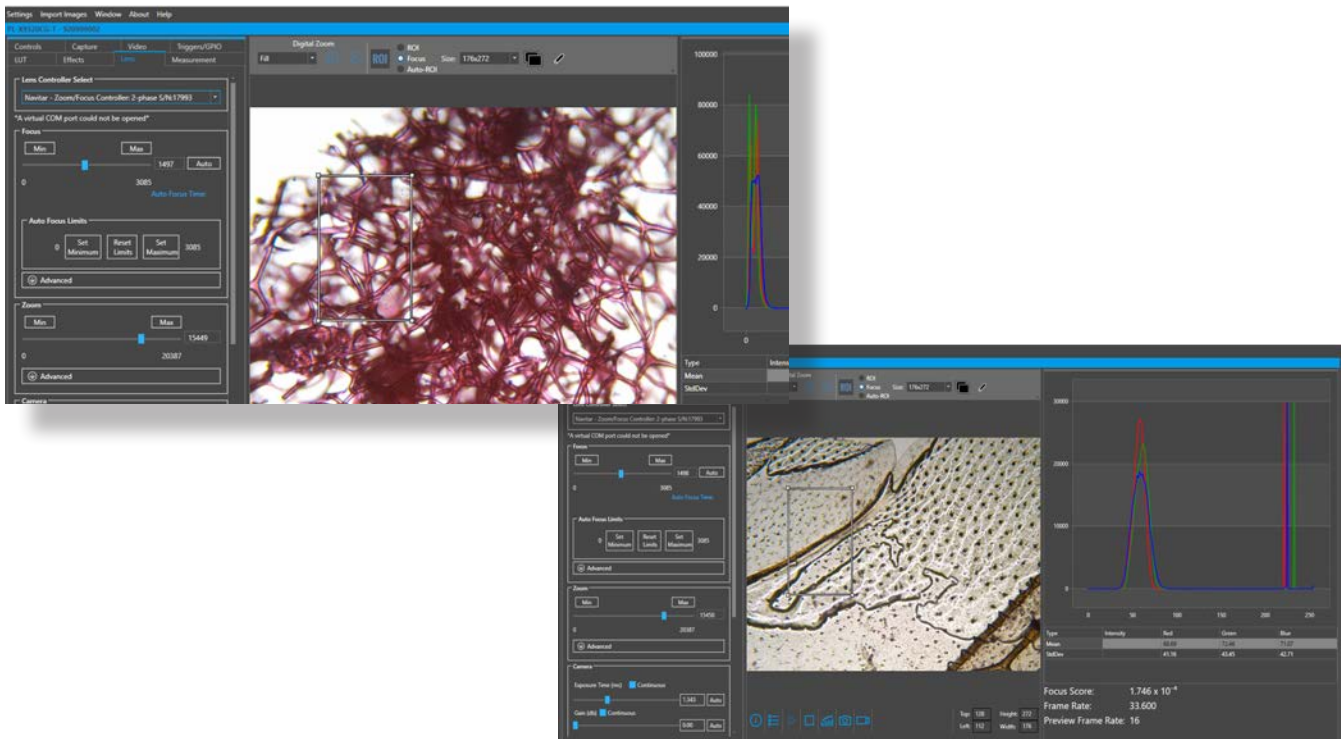

## Software Development Kit (SDK)

- Powerful, Easy to Use Interface
- Seamless Integration
- Free Technical Support
- U3V and GEV Compliant

Providing full control of all camera functions, the Pixelink SDK is the software package of choice for developers and system integrators. The SDK facilitates the faster creation of customer applications. It presents complex standards based features as easy to understand concepts, and includes a rich set of sample applications for reference/use.

### Compliance Standards

U3V compliant on all USB 3.0 cameras. GEV compliant on all GigE and 10 GigE cameras.

### Common API

Same API used for all camera types & operating systems (application code is re-usable)

### Compatible Languages:

C, C++, Python and Microsoft.NET

### Available Drivers:

USB 3.0, USB 2.0, GigE, Direct Show and TWAIN

### Third Party Software Compatibility to Include:

LabVIEW, MATLAB, GenICam GenTL, Halcon, Norpix, Micro-Manager and Matrox

## Camera Lens Solutions

High-Resolution, Low-Noise, Digital Imaging Solutions



We've simplified the lens and camera selection process by pairing proven high-speed USB 3.0 Pixelink industrial camera models with Navitar® high magnification imaging lens systems to meet the needs of your most demanding machine vision application.

Navitar's Resolv4K, 12X Zoom and Zoom 6000 product lines seamlessly integrate with Pixelink CMOS cameras. Advanced lens system functionality, such as motorized zoom and focus control, and autofocus fine-focus adjust, is achieved with Pixelink Capture software (included with all Pixelink camera purchases).

Contact a Navitar account representative or visit [navitar.com](http://navitar.com) for more details.



### Available Interfaces



Visit [pixelink.com](http://pixelink.com)  
to view our full line of products.

## Quick Reference Guide

### How to Determine the Focal Length Required

To choose the proper lens for an application consider the following:

- Field of View (FOV) - The size of the area to be imaged.
- Working Distance (WD) - Distance from the camera lens to the object or area under surveillance.
- CCD - The size of the camera's image sensor device.

Be consistent. If you are measuring the width of your object, use the horizontal CCD specifications, etc. If you are working in inches, do your calculations in inches and convert to millimeters at the end.

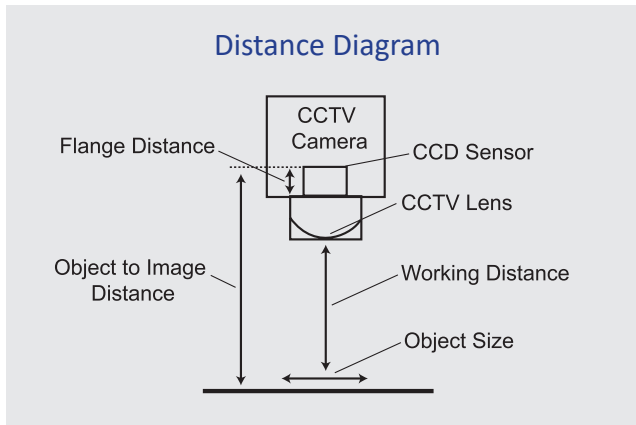

### Understanding Focal Length

Video lenses are classified into three categories according to focal length: standard, wide angle and telephoto. Focal length is the distance between the camera sensor and the center of the lens. The greater the focal length, the larger the image will appear. Therefore, the greater the focal length, the more the lens becomes telephoto in application.

**Standard Lens** - size of the object being viewed is unchanged.

**Wide Angle Lens** - provides a wider field of view and therefore a smaller image of the object being viewed.

**Telephoto Lens** - produces a larger image of a distant object. The longer the focal length, the larger the object will appear.

$$FL = \frac{CCD \times WD}{FOV}$$

**Example:** You have a 1/3" C-mount CCD camera (4.8 mm horizontal). There is a 12" (305 mm) distance between the object and the front of the lens. The field of view, or object size, is 2.5" (64 mm). The conversion factor is 1" = 25.4 mm (round up).

Calculations in millimeters:  
 FL = 4.8 mm x 305 mm / 64 mm  
 FL = 1464 mm / 64 mm  
 FL = 23 mm Lens Required

Calculations in inches:  
 FL = 0.19" x 12" / 2.5"  
 FL = 2.28" / 2.5"  
 FL = 0.912" x 25.4 mm/inch  
 FL = 23 mm Lens Required

### Understanding F/#

The f/number is an indication of the brightness of the lens. It is the measurement of the ratio between the focal length and the diameter of the entrance pupil (where the light enters the lens). It determines the amount of light reaching the camera sensor. The smaller the value, the larger the opening and the brighter the image produced by the lens.

### Image Size

A lens produces images in the form of a circle, called the image circle. In a video camera, the imaging element has a rectangular sensor area (the image size) that detects the image produced within the image circle. The ratio of the length of the horizontal to vertical sides of a video image is called the aspect ratio, which is normally 4:3 (H:V) for a standard video camera.

Image Size Chart			
Sensor Format	Image Circle	Horizontal	Vertical
1/3"	∅ 6.0 mm	4.8 mm	3.6 mm
1/2"	∅ 8.0 mm	6.4 mm	4.8 mm
2/3"	∅ 11.0 mm	8.8 mm	6.6 mm
1"	∅ 16.0 mm	12.8 mm	9.6 mm
4/3"	∅ 22.5 mm	17.3 mm	13.0 mm
35mm	∅ 43.0 mm	36.0 mm	24.0 mm

### Image Sensor Size (units in mm)

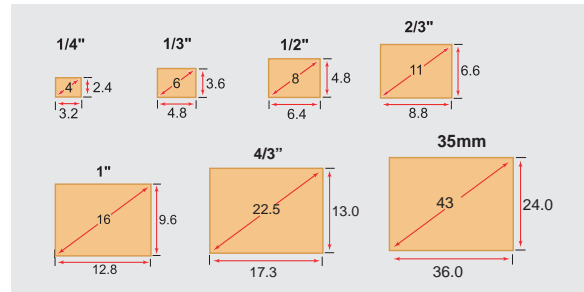

### Image Size

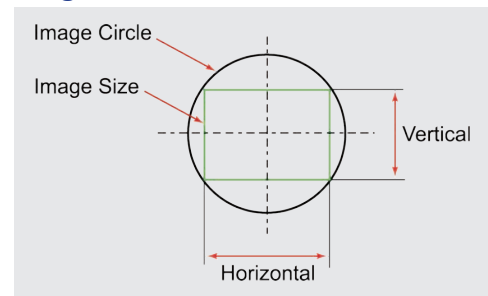

### Minimum Object Distance

Minimum object distance (M.O.D.) indicates how close the lens can be placed to the object for shooting. It is measured from the vertex of the front glass of the lens.



### Angle of View and Field of View

The angle of view is the shooting range that can be viewed by the lens given a specified image size. Normally the angle of view is measured assuming a lens is focused at infinity. The angle of view can be calculated if the focal length and image size are known. If the distance of the object is finite, the angle is not used. Instead, the dimension of the range that can actually be shot, or the field of view, is used.

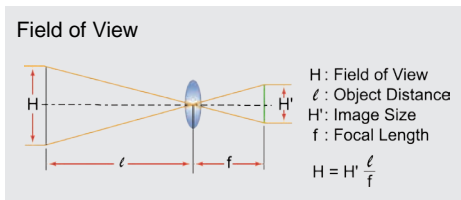
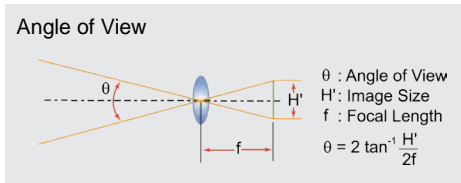

### Focal Length

Distance between the principle point in the optical system and the focal point. For a single thin lens, the focal length is equal to the distance between the center of the lens and the focal point.

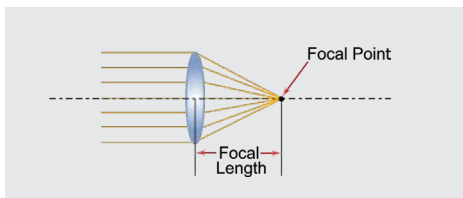

### Back Focal Length

Distance between vertex of the rear element lens and image sensor.

### Flange Distance

Distance between mechanical mount surface and image sensor (in air).

C-Mount=17.526 mm / .690"

CS-Mount=12.526 mm / .493"

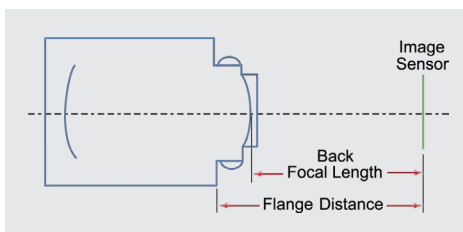

### Relationship Between Angle of View and Image Sensor Size

Cameras with different image sensor chip sizes (such as 1/3", 1/2", 2/3", 1" and 4/3"), using the same focal length lens, will each yield a different field of view.

Lenses designed for a larger image sensor device will work on a new, smaller size camera. However, if a lens designed for a smaller format image sensor device (i.e. 1/3") is placed on a larger one (i.e. 2/3"), the image on the monitor will have dark corners.

Image sensor sizes are in a ratio of 1:0.69:0.5:0.38:0.25. This means that a 1/2" format is 50% of a 1" format, a 1/2" format is 75% of a 2/3" format and a 1/3" format is 75% of a 1/2" format.

### Camera to Monitor Magnification

Camera Format	Monitor Size (diagonal)					
	9"	14"	15"	18"	20"	27"
1/3"	38.1X	59.2X	63.5X	76.2X	84.6X	114.1X
1/2"	28.6X	44.5X	47.6X	57.2X	63.5X	85.7X
2/3"	20.8X	32.3X	34.6X	41.6X	46.2X	62.3X
1"	14.3X	22.2X	23.8X	28.6X	31.8X	42.9X
4/3"	10.6X	16.4X	17.6X	21.1X	23.5X	31.7X

### C-Mount and CS-Mount Lens Compatibility

When using a C-mount lens for a CS-mount camera, a C/CS-mount adapter (5mm thick) is required.

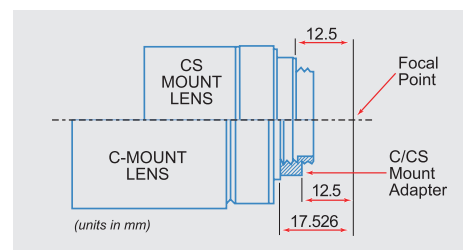

### General Lens Formulas

#### Magnification

$m = \text{Image Size} / \text{Object Size}$

#### Object to Image Distance

$OI = [FL \times (1+m)^2] / m$   
 $OI = m(FL) + (FL+VOA+BF) + FL/m$   
 VOA = Vertex to Vertex Lens Length

#### Object to Lens Distance

$OL = FL + FL(m)$

#### Lens to Image Distance

$LI = FL + FL/m$

(~ distance to the nodal points:  
 $FL + FL(m)$  to the front vertex.)

$F/\# = 1/(2NA)$

$F/\# = FL / \text{Entrance Pupil Diameter}$

$NA = 1/2 F/\#$

$NA = \sin \theta/2$

#### Effective F/#

$\text{Eff. } F/\# = F/\# (m+1)$

#### Clear Aperture (Minimum)

$\text{Aperture} = FL / (F/\#)$

#### Depth of Focus

$\text{DoF} = 0.00002 / NA^2$  (in inches)

$\text{DoF} = 0.0005 / NA^2$  (in mm)

#### Conversion Factors

1 inch = 25.4 millimeters

1 meter = 39.37 inches

1 degree =  $\pi / 180$  radians

1 degree = 0.0174533 radians

1 micron ( $\mu$ ) = 0.001 millimeter

1 micron ( $\mu$ ) = 1,000 nanometers

1 micron ( $\mu$ ) = 10,000 angstroms



**SPECIAL OPTICS®**  
A NAVITAR COMPANY

**Pixelink®**  
A NAVITAR COMPANY



**The Navitar Companies**  
Providing Integrated Imaging Systems for Every Application

200 Commerce Drive, Rochester, New York 14623  
info@navitar.com | 585.359.4000 | www.navitar.com