

• • • ept
connectors



New Products

April 2016

Symbols

Mating configuration



Parallel



Perpendicular



Horizontal



Direct Connector



Cable

Termination



SMT



Press-fit



Through-Hole



THTR

Application



Power



High Speed





High Density



Rugged

Table of contents

<p>One27® 1.27 mm SMT for Board-to-Board</p>		<p>.....4</p>
<p>flexilink 2.54 mm Board-to-Board Connections in Press-fit</p>		<p>.....26</p>
<p>flexilink_{jumper} Horizontal Board-to-Board Connections in Press-fit</p>		<p>.....30</p>
<p>Colibri® 0.5 mm SMT for 10+ Gbit/s Applications</p>		<p>COM Express®36</p>
<p>DIN 41612 / IEC 60603-2 New Types in THTR</p>		<p>DIN 41612 / IEC 60603-244</p>
<p>NFF 16-101 / NFF 16-102 Connectors for Railway Technology according to DIN 41612</p>		<p>NFF 16-101 / NFF 16-10262 DIN 41612 / IEC 60603-2</p>
<p>Customer Specific Connectors Individually developed and produced</p>		<p>.....64</p>

One27 – 1.27 mm SMT for Board-to-Board Applications

Versatile, Robust, Compact

ept's new series of One27 provides connectors that are highly flexible in design options for board-to-board applications, offering highest reliability of interconnections. The product family is based upon a pitch of 1.27 mm.

There are available many different connector types including straight and angled versions, as well as flat cable connections. The pin count ranges from 12 to 80. The One27 female IDC is available separately or pre-assembled with a cable. ept's One27 connectors are fully compatible with already available products in the market.

The design of ept's One27 connectors was focused upon a highest demand for functionality, robustness, and ease of use.

Key Features:

- 12 to 80 pins
- 1.4 A operational current
- 500 mating cycles
- reliable contact
- tested compatibility with other suppliers
- female IDC separately or pre-assembled with a cable available
- packed in Tape & Reel

Applications:

- board-to-board (mezzanine) from 8 mm up to 13.8 mm
- parallel and perpendicular connection
- IDC-connection with ribbon cable

Termination



SMT

Application



High Density



One27 – Product Overview

Type of One27 connector	Height	Number of pins	Mating configuration				Page	
			 Parallel	 Horizontal	 Perpendicular	 Cable		
	Male low-profile	1.75 mm	12 ... 80	<input checked="" type="checkbox"/>		<input checked="" type="checkbox"/>	<input checked="" type="checkbox"/>	10
	Male mid-profile	3.25 mm	12 ... 80	<input checked="" type="checkbox"/>		<input checked="" type="checkbox"/>	<input checked="" type="checkbox"/>	12
	Male angled		12 ... 80		<input checked="" type="checkbox"/>	<input checked="" type="checkbox"/>	<input checked="" type="checkbox"/>	14
	Female low-profile	6.25 mm	12 ... 80	<input checked="" type="checkbox"/>		<input checked="" type="checkbox"/>		16
	Female mid-profile	9.05 mm	12 ... 80	<input checked="" type="checkbox"/>		<input checked="" type="checkbox"/>		18
	Female angled		12 ... 80		<input checked="" type="checkbox"/>	<input checked="" type="checkbox"/>		20
	Female IDC		12 ... 80				<input checked="" type="checkbox"/>	22
	Female IDC pre-assembled with cable		12 ... 80				<input checked="" type="checkbox"/>	24

Advantages of One27

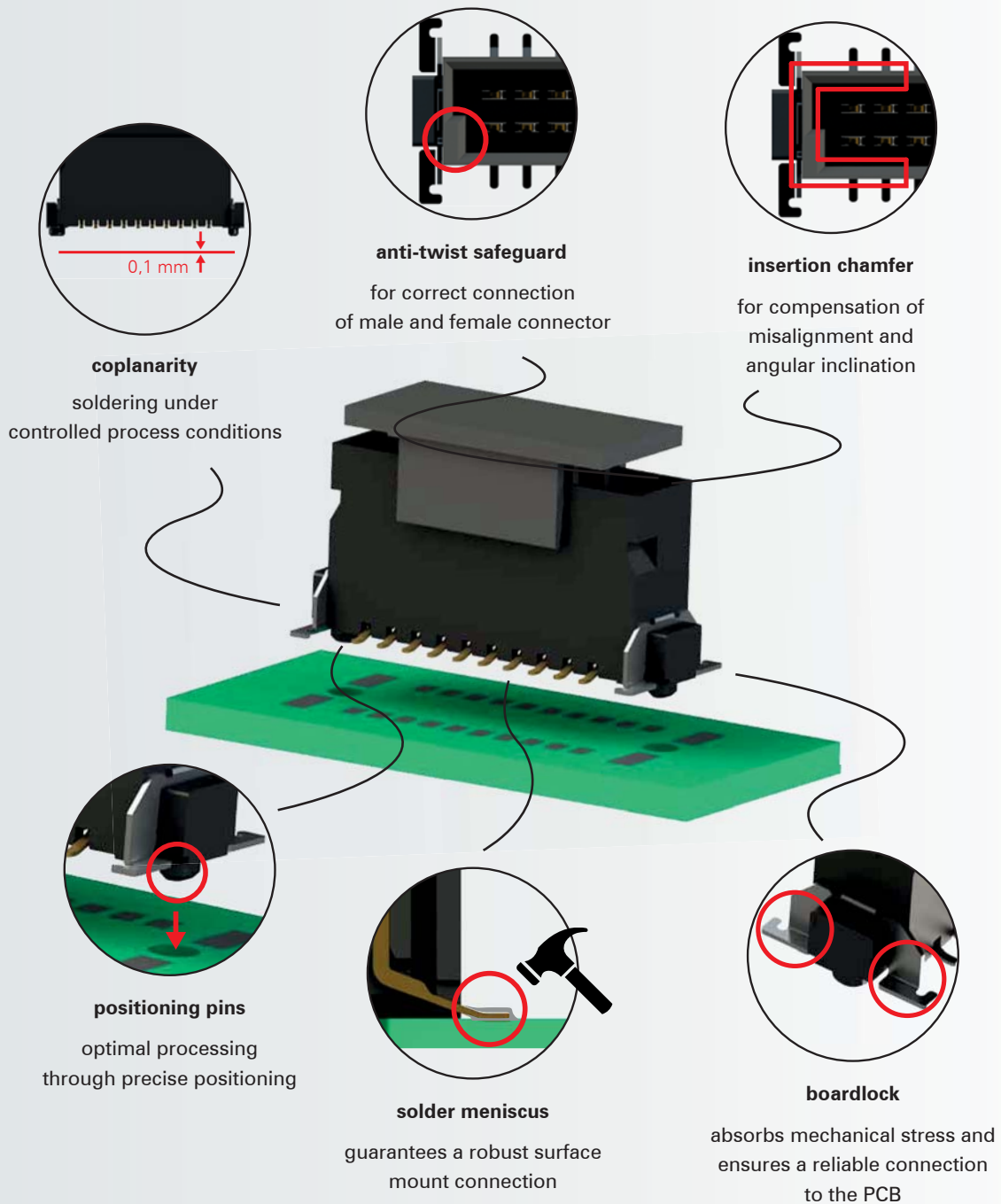

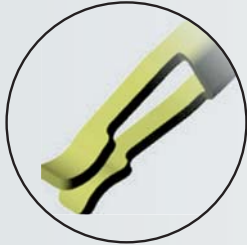

smooth surface

secure contact mating
on the rolled, homogeneous
surface

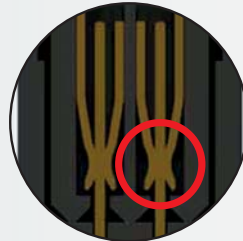

spring contacts

for secure and reliable
contact mating

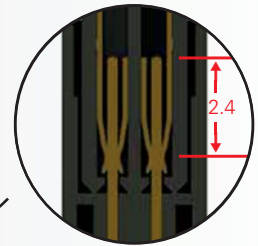

wipe length

reliability through high
tolerance compensation

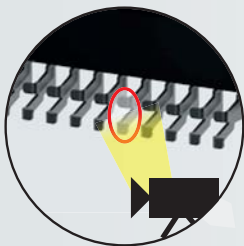

AOI-control

optimized contact design for
automated testing after soldering

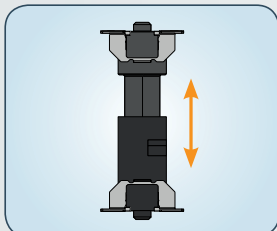
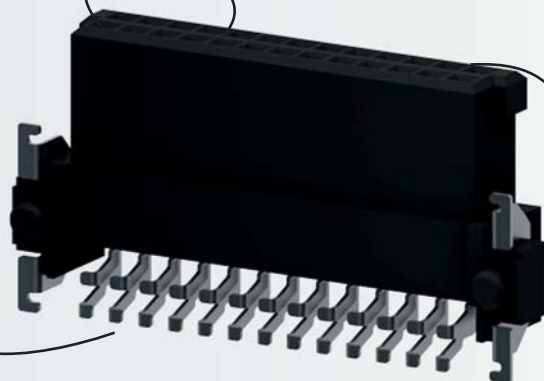

Test reports prove the
compatibility with other
connectors available on the
market



Tape & Reel packaging for
automatic assembly



IDC connector available without
ribbon cable for individual cable
lengths

PCB Distances Board-to-Board

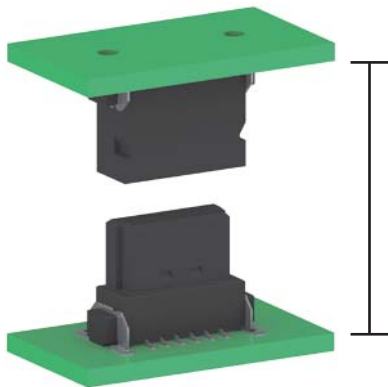

8.00 - 13.8 mm

Board-to-board distances of 8.00 mm up to 13.8 mm can be achieved using One27 connectors.

PCB distance min. - max.	Male connector height	Female connector height
8.00 - 9.50 mm	low-profile 1.75 mm <i>(see p. 10)</i>	low-profile 6.25 mm <i>(see p. 16)</i>
9.50 - 11.00 mm	mid-profile 3.25 mm <i>(see p. 12)</i>	low-profile 6.25 mm <i>(see p. 16)</i>
10.80 - 12.30 mm	low-profile 1.75 mm <i>(see p. 10)</i>	mid-profile 9.05 mm <i>(see p. 18)</i>
12.30 - 13.80 mm	mid-profile 3.25 mm <i>(see p. 12)</i>	mid-profile 9.05 mm <i>(see p. 18)</i>

**Connection for
min. PCB distance**

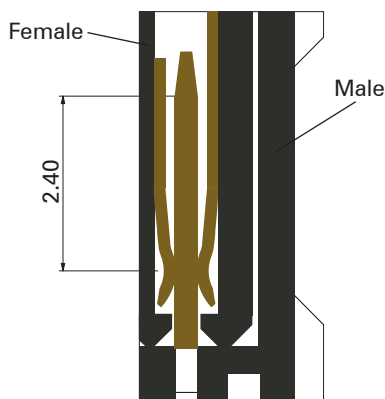

The minimum possible board-to-board distance is achieved by plugging the connector all the way in to the stop position.

**Connection for
max. PCB distance**

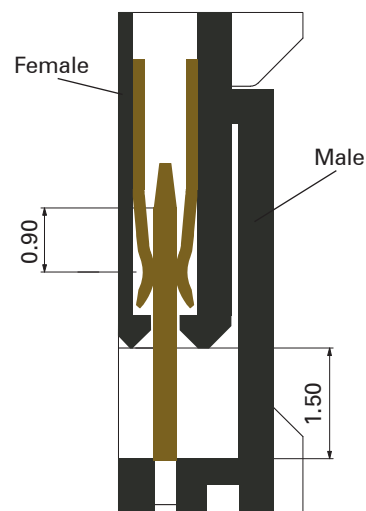

The male and female can be inserted anywhere within a range of 1.5 mm, thus allowing for the maximum possible board-to-board distance. The remaining 0.9 mm ensures secure contact mating.

Technical Specification

Technical specification	One27	
	Test Standard	1.27 mm SMT Board-to-Board Connectors; IDC Cable Assembly
Basics		
Number of pins		12 / 16 / 20 / 26 / 32 / 40 / 50 / 68 / 80
Termination		SMT
Operating temperature range		-55°C to +125°C (Board-to-Board Connectors)
Material		
Insulator material		LCP, UL 94 V-0
CTI value	IEC 60112	175
Contact material		Copper alloy
Contact surface		Au over PdNi over Ni / Au over NiP over Ni
Termination area		Sn
Mechanical		
Pitch		1.27 mm
Mating force per pin		0.5 N
Seperating force per pin		0.5 N
Durability	IEC 60512-9-1:2010	Performance level I: 500 mating cycles
Coplanarity		max. 0.1 mm
Vibration, sinusoidal	IEC 60512-6-4:2002	10 - 200 Hz 20 g
Contact mating problems if vibrations occur, sinusoidal	IEC 60512-2-5:2003	< 1 µs
Shock, semi-sinusoidal	IEC 60512-6-3:2002	50 g 11 ms
Contact mating problems if shocks occur, semi-sinusoidal	IEC 60512-2-5:2003	< 1 µs
Electrical		
Operational current	IEC 60512-5-2:2002	max. 1.4 A at 20°C (50 pins)
Contact resistance	IEC 60512-2-1:2002	max. 25 mΩ max. 10 mΩ (Female IDC assembled with cable)
Clearance and creepage		min. 0.4 mm
Insulation resistance	IEC 60512-3-1:2002	max. 10 GΩ
Test voltage	IEC 60512-4-1:2003	500 VAC
Processing		
Soldering temperature	JEDEC J-STD-020E	max. SMT reflow soldering temperature 20 - 40 s at 260°C
MSL	JEDEC J-STD-020E	1
Packaging		Tape and Reel, Tray (IDC female connector)
Assembly		Pick and place
Approval		
UL file		E130314
Environment		RoHS compliant

Male connector low-profile

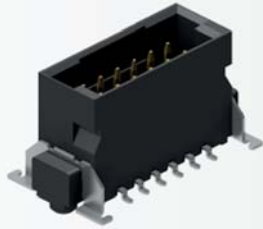

Type: Male connector straight low-profile
1.75 mm unmated

Number of pins: 12 to 80

Pitch: 1.27 mm

Operational current: 1.4 A at 20°C (50 pins)

Packaging: Tape and Reel



Standards:  

Technical Specification on page 9

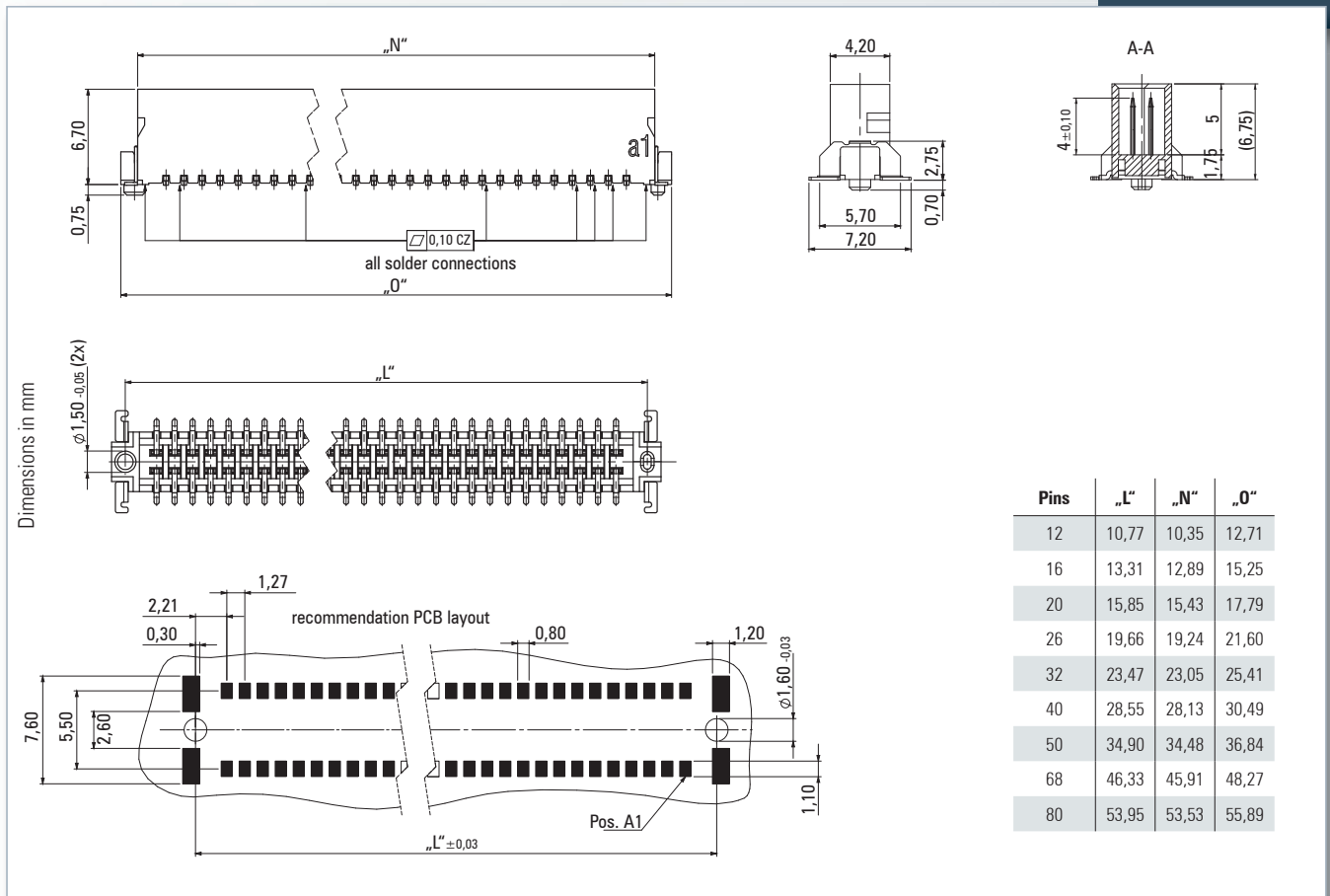
For drawings and technical data visit www.ept.de



Mating connector / Application:

-  for parallel applications (p. 16-19)
-  for perpendicular applications (p. 20-21)
-  for applications with cable (p. 22-25)



Male connector low-profile - Performance level I

Number of pins	Part number
12	403-52012-51
16	403-52016-51
20	403-52020-51
26	403-52026-51
32	403-52032-51
40	403-52040-51
50	403-52050-51
68	403-52068-51
80	403-52080-51

On request

- different number of pins
- other performance level

Male connector mid-profile

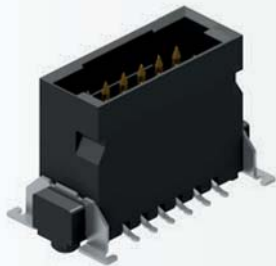

Type: Male connector straight mid-profile
3.25 mm unmated

Number of pins: 12 to 80

Pitch: 1.27 mm

Operational current: 1.4 A at 20°C (50 pins)

Packaging: Tape and Reel

Standards:

Technical Specification on page 9

For drawings and technical data visit www.ept.de

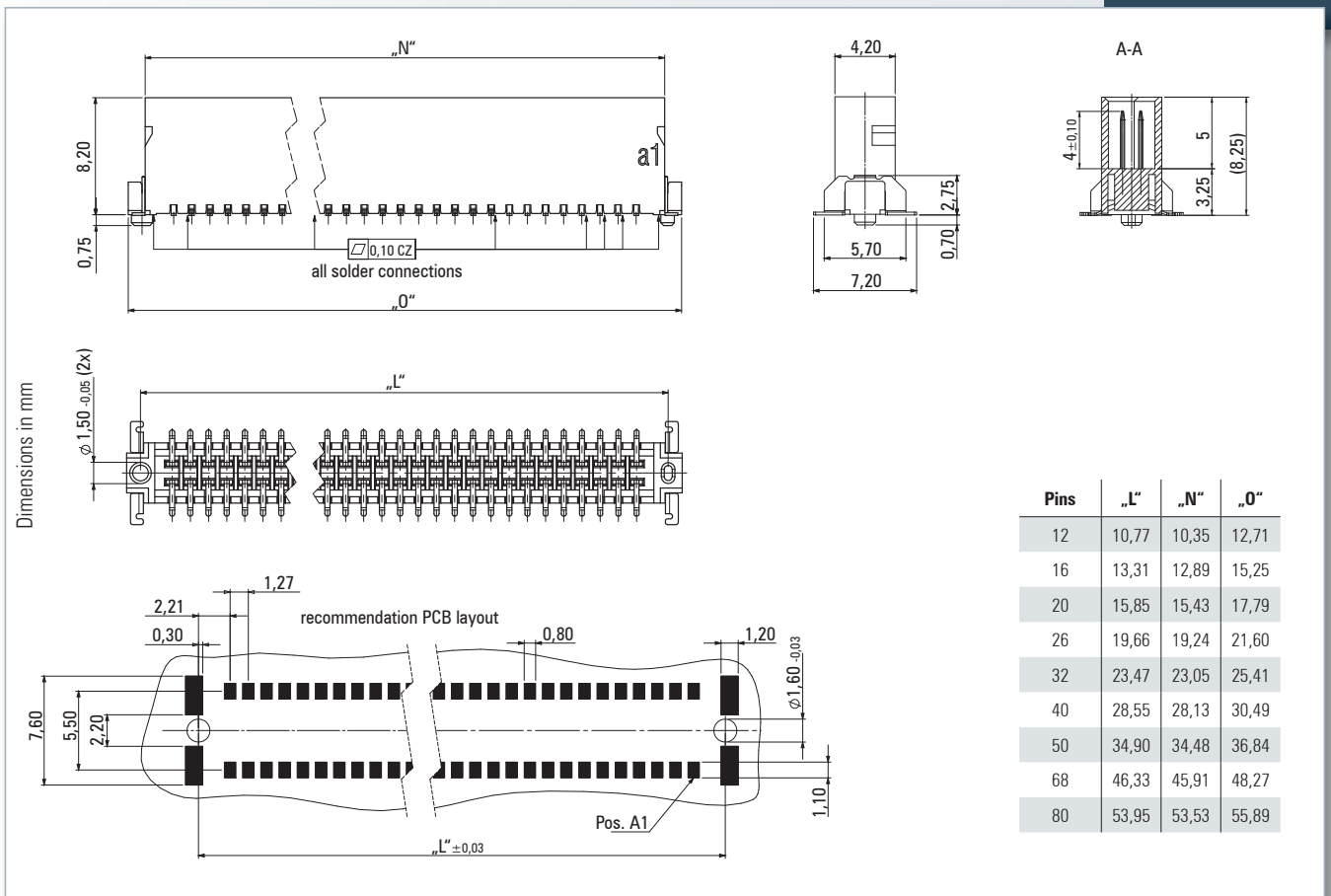

Mating connector / Application:

- for parallel applications (p. 16-19)
- for perpendicular applications (p. 20-21)
- for applications with cable (p. 22-25)



Male connector mid-profile - Performance level I •••

Number of pins	Part number
12	403-53012-51
16	403-53016-51
20	403-53020-51
26	403-53026-51
32	403-53032-51
40	403-53040-51
50	403-53050-51
68	403-53068-51
80	403-53080-51

On request

- different number of pins
- other performance level

Male connector angled



Type: Male connector angled

Number of pins: 12 to 80

Pitch: 1.27 mm

Operational current: 1.4 A at 20°C (50 pins)

Packaging: Tape and Reel

Standards:

Technical Specification on page 9

For drawings and technical data visit www.ept.de

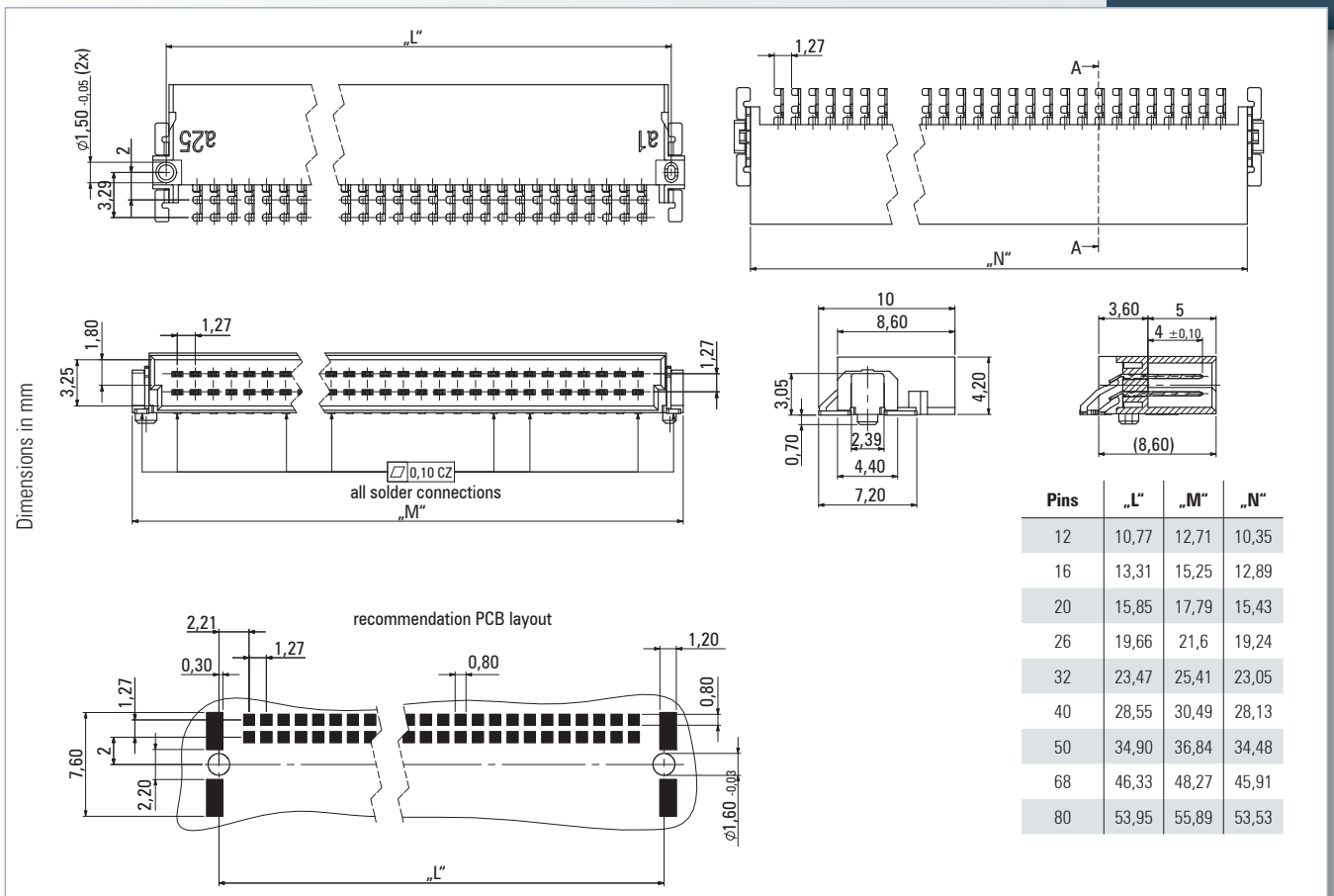

Mating connector / Application:

- for horizontal applications (p. 20-21)
- for perpendicular applications (p. 16-19)
- for applications with cable (p. 22-25)



Male connector angled - Performance level I •••

Number of pins	Part number
12	403-51012-51
16	403-51016-51
20	403-51020-51
26	403-51026-51
32	403-51032-51
40	403-51040-51
50	403-51050-51
68	403-51068-51
80	403-51080-51

On request

- different number of pins
- other performance level

Female connector low-profile

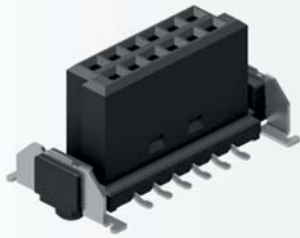

Type: Female connector straight low-profile
6.25 mm unmated

Number of pins: 12 to 80

Pitch: 1.27 mm

Operational current: 1.4 A at 20°C (50 pins)

Packaging: Tape and Reel

Standards:

Technical Specification on page 9

For drawings and technical data visit www.ept.de

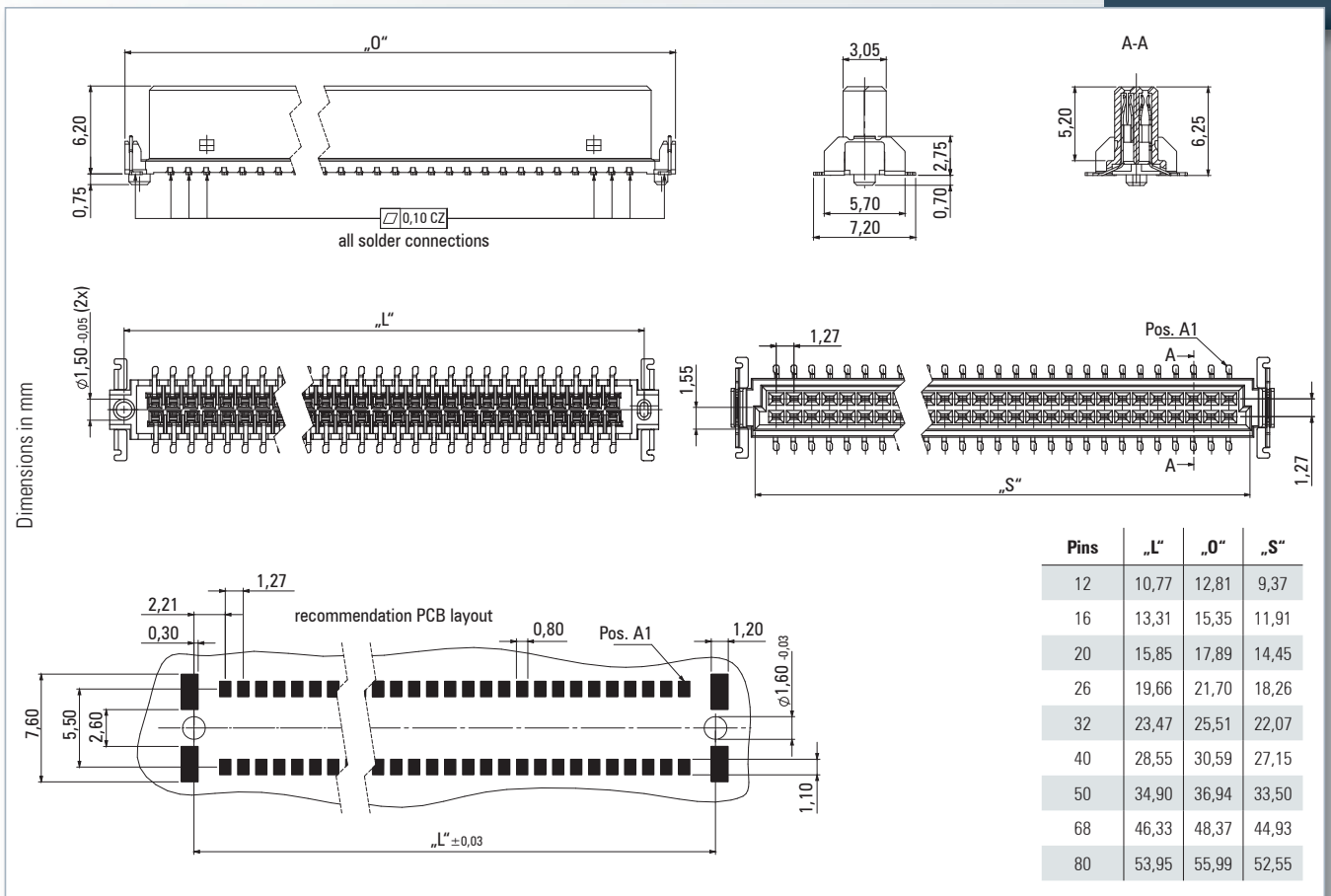

Mating connector / Application:

for parallel applications (p. 10-13)

for perpendicular applications (p. 14-15)



Female connector low-profile - Performance level I

Number of pins	Part number
12	404-52012-51
16	404-52016-51
20	404-52020-51
26	404-52026-51
32	404-52032-51
40	404-52040-51
50	404-52050-51
68	404-52068-51
80	404-52080-51

On request

- different number of pins
- other performance level

Female connector mid-profile



Type: Female connector straight mid-profile
9.05 mm unmated

Number of pins: 12 to 80

Pitch: 1.27 mm

Operational current: 1.4 A at 20°C (50 pins)

Packaging: Tape and Reel

Standards:  

Technical Specification on page 9

For drawings and technical data visit www.ept.de

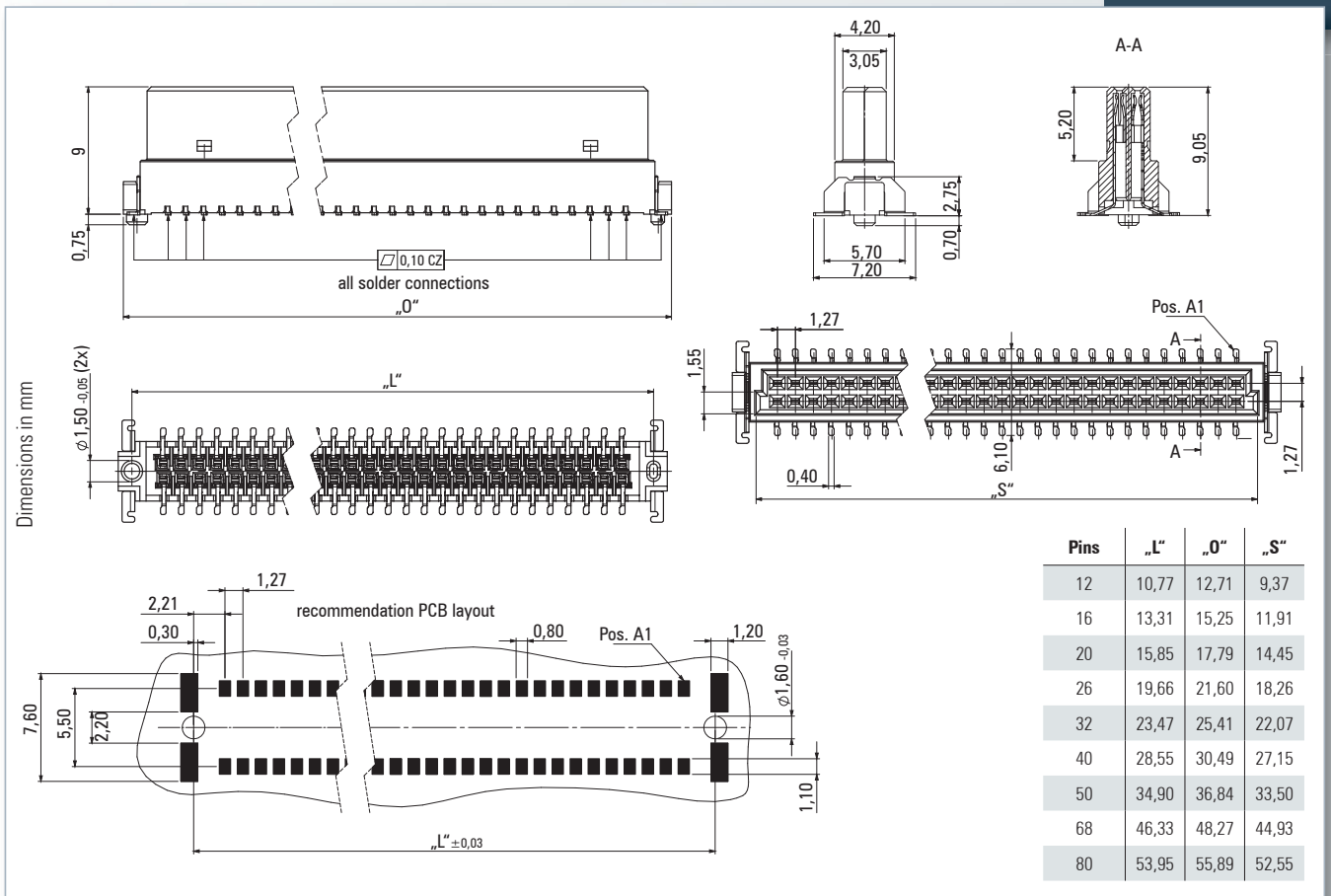

Mating connector / Application:

 for parallel applications (p. 10-13)

 for perpendicular applications (p. 14-15)



Female connector mid-profile - Performance level I

Number of pins	Part number
12	404-53012-51
16	404-53016-51
20	404-53020-51
26	404-53026-51
32	404-53032-51
40	404-53040-51
50	404-53050-51
68	404-53068-51
80	404-53080-51

On request

- different number of pins
- other performance level

Female connector angled



Type: Female connector angled

Number of pins: 12 to 80

Pitch: 1.27 mm

Operational current: 1.4 A at 20°C (50 pins)

Packaging: Tape and Reel

Standards:

Technical Specification on page 9

For drawings and technical data visit www.ept.de

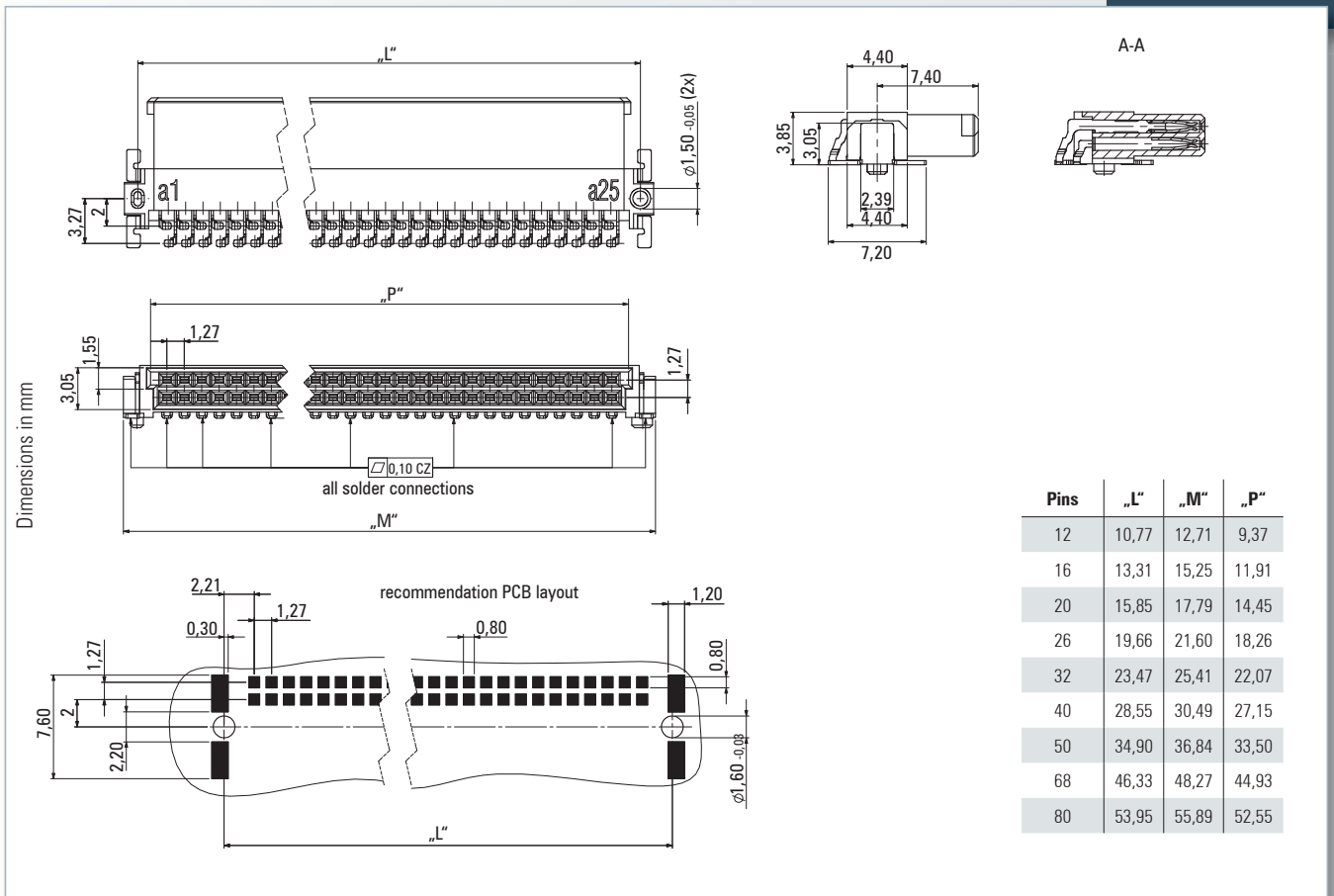

Mating connector / Application:

for horizontal applications (p. 14-15)

for perpendicular applications (p. 10-13)



Female connector angled - Performance level I •••

Number of pins	Part number
12	404-51012-51
16	404-51016-51
20	404-51020-51
26	404-51026-51
32	404-51032-51
40	404-51040-51
50	404-51050-51
68	404-51068-51
80	404-51080-51

On request

- different number of pins
- other performance level

Female connector IDC



Type: Female connector IDC

Number of pins: 12 to 80

Pitch: 1.27 mm

Packaging: Tape and Reel

Standards:

Technical Specification on page 9

For drawings and technical data visit www.ept.de

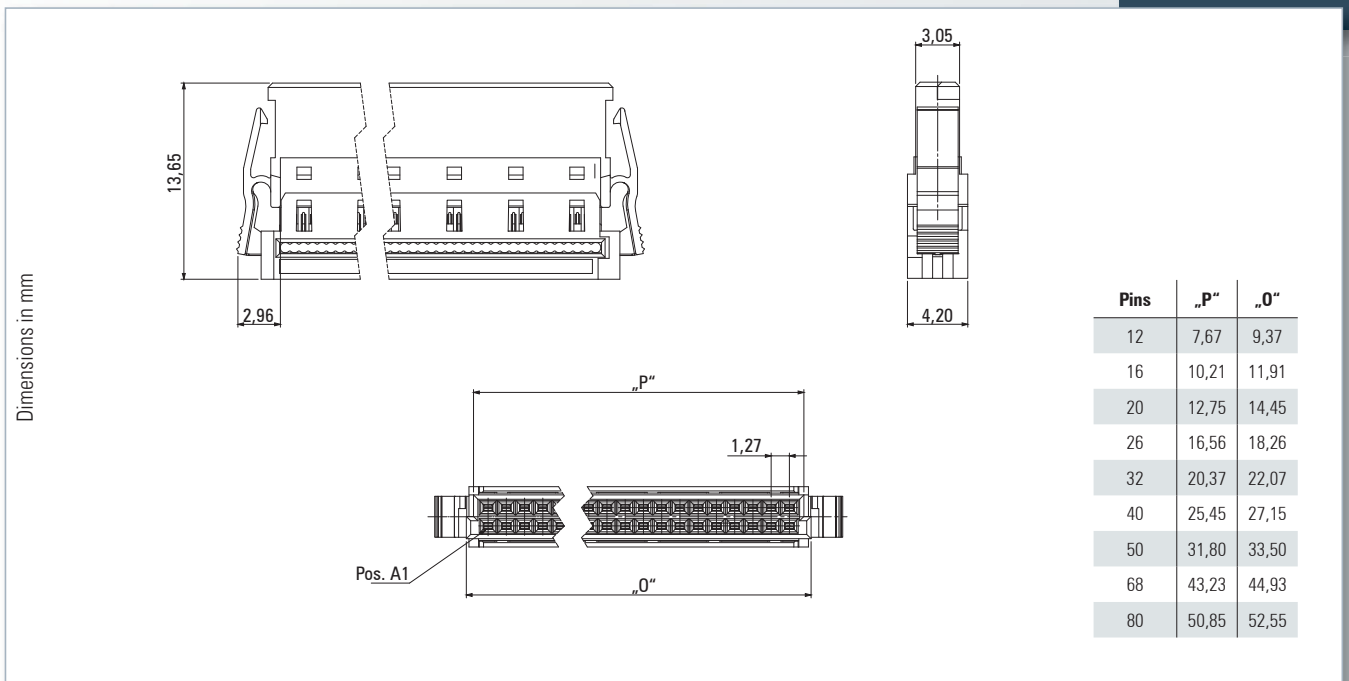

Note

The female IDC is designed to be reused for cable assembly. Observe the recommendations for processing.

Mating connector / Application:

Mating connector straight (p. 10-13)

Mating connector angled (p. 14-15)

Cable assembly for female IDC (p. 24-25)



Female connector IDC - Performance level I •••

Number of pins	Part number
12	404-59012-61
16	404-59016-61
20	404-59020-61
26	404-59026-61
32	404-59032-61
40	404-59040-61
50	404-59050-61
68	404-59068-61
80	404-59080-61

On request

- different number of pins
- other performance level
- pre-assembled with cable (p. 24-25)

One27 Female IDC pre-assembled with cable



- female connector IDC see p. 22 and 23
- user defines orientation of connectors, number of pins and cable length
- AWG 30/7
- assembly in insulation displacement connectors (IDC)
- three cable types available
- colored lead on a1

Product key

404 - 6XNN - LLL - CCC - 1

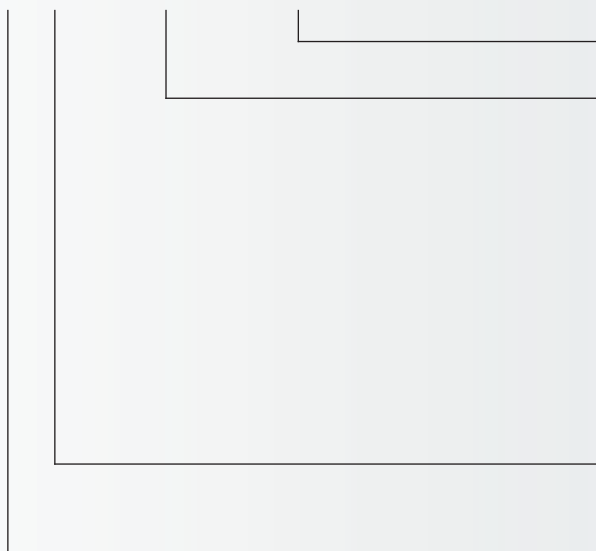

see next page

Length of cable in mm

from 50 to 999 mm
e. g. 080 = 80 mm
660 = 660 mm

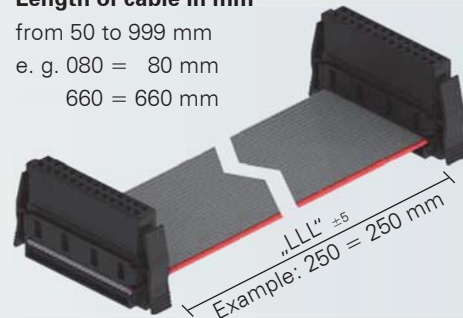

Number of pins

12, 16, 20, 26, 32, 40, 50, 68, 80

Type of cable

X	Type of cable	Temperature area
1	PVC	-30°C to +105°C (in idle state)
2	TPE-S (high-temperature-resistant)	-60°C to +125°C (in idle state)
3	TPE-0 (Halogen-free)	-40°C to +105°C (in idle state)

Data sheets on request

Assembled versions

Assembled version 120

Part number
404-6XNN-LLL-120-1

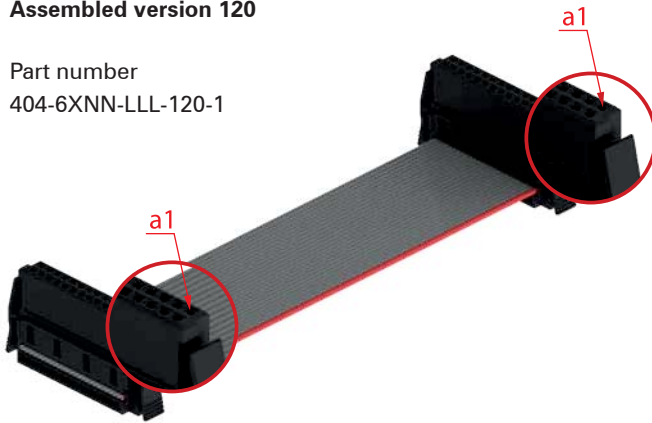

Assembled version 100

Part number
404-6XNN-LLL-100-1

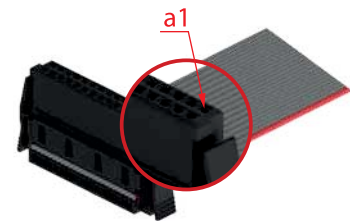

Assembled version 420

Part number
404-6XNN-LLL-420-1

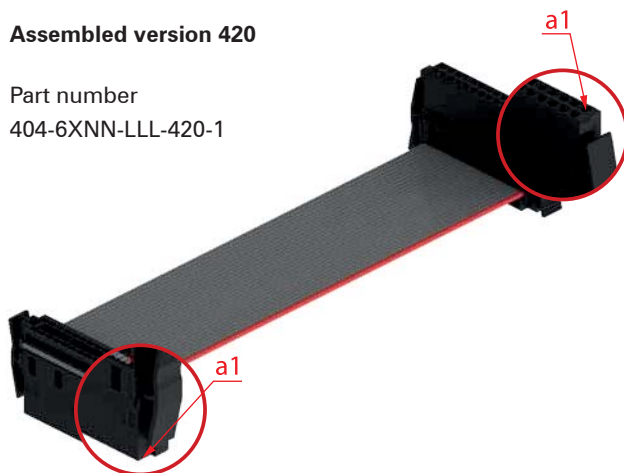

Assembled version 400

Part number
404-6XNN-LLL-400-1

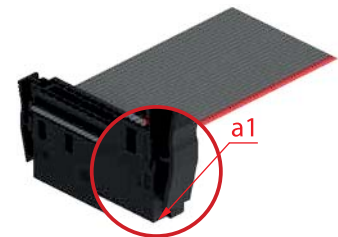

Assembled version 130

Part number
404-6XNN-LLL-130-1

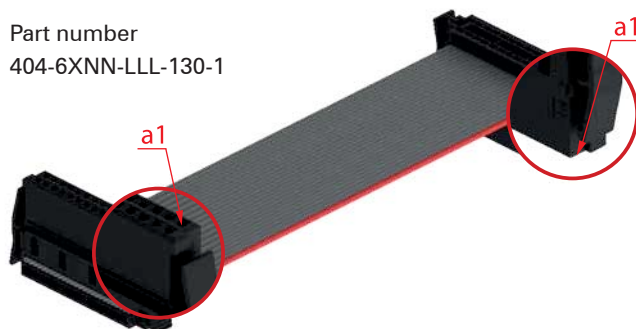

On request

- other assembled versions

flexilink_{b-t-b} – 2.54 mm Board-to-Board Connection in Press-fit

Versatile and Reliable

flexilink is the perfect solution when you are looking for a high-quality press-fit connection between PCBs.

The advantages are obvious: with only one element you create a mechanical as well as electrical connection. Standoffs are redundant, which saves costs and space on the PCB.

In addition you can choose within a range of 5 up to 25 mm board-to-board distance and combine different rows and contact numbers.

Key Features:

- 8 A operational current per pin
- reliable mechanical and electrical connection
- space & cost saving
- only one element for one connection
- individual board-to-board distance possible
- press-fit zone Tcom press®

Applications:

- board-to-board from 5 up to 25 mm
- high mechanical stress, shock & vibration
- elimination of soldering process through press-fit technology

Termination



Press-fit

Mating configuration



Parallel





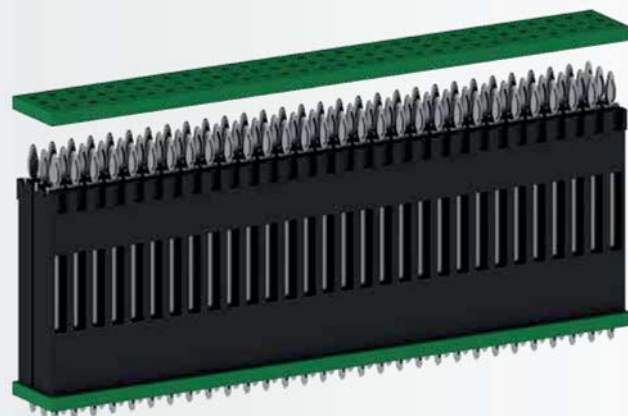

Application



Power



flexilink_{b-t-b} – Product Overview

Height	 Parallel	Rows	Number of pins
	5 mm	1, 2, 3	2 - 90
	10 mm	1, 2, 3	2 - 90
	15 mm	1, 2, 3	2 - 90
	20 mm	1, 2, 3	2 - 90
	25 mm	1, 2, 3	2 - 90
individual	5 - 25 mm	1, 2, 3	2 - 90

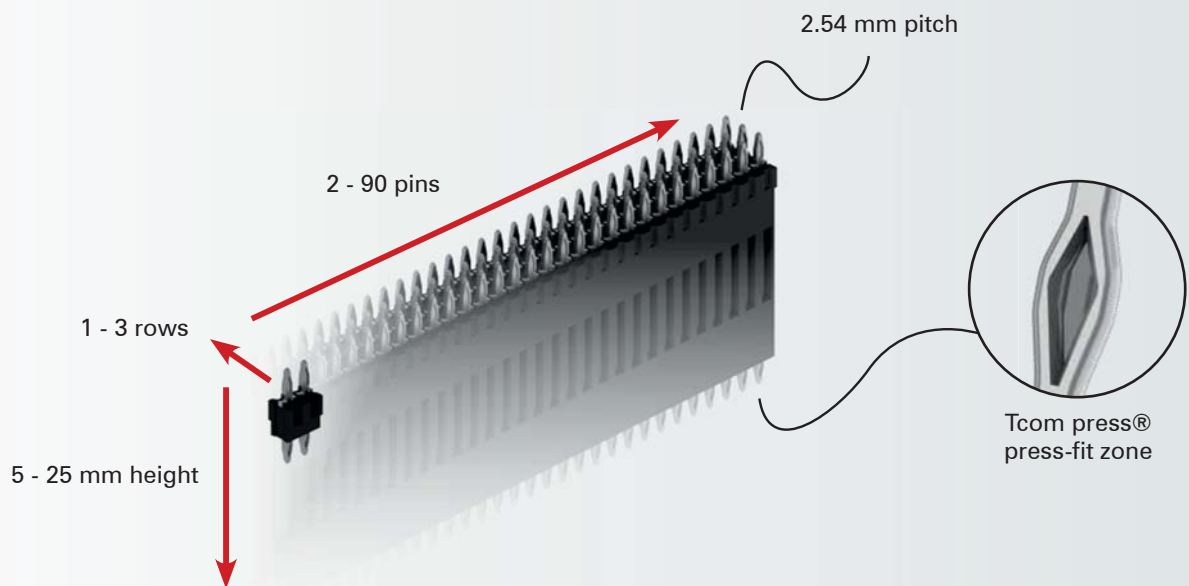

flexilink_{b-t-b} – Applications

Requirement		Advantage flexilink _{b-t-b}
Ruggedized	Shock and vibration, temperature resistance, corrosive gas	<ul style="list-style-type: none"> reliable connection between contact and PCB hole permanent connection without intersection, as of no socket terminal
Modularity	Installation of modules on carrier board at the end of assembly process	<ul style="list-style-type: none"> easy and safe processing (no soldering) reliable mechanical connection
Saving of space	Limited space	<ul style="list-style-type: none"> small height only one element
Saving of costs	Best cost-value ratio of an application	<ul style="list-style-type: none"> only one component reliable mechanical connection easy processing
Operational current	High operational current	<ul style="list-style-type: none"> permanent connection without intersection, as of no socket terminal 5.08 mm pitch possible
Contact resistance	Lowest contact resistance	<ul style="list-style-type: none"> permanent connection without intersection, as of no socket terminal
Production process	Avoidance of selective soldering	<ul style="list-style-type: none"> easy and safe processing (no soldering)
Miniaturization	Connection of smallest PCBs, e.g. for sensor technology	<ul style="list-style-type: none"> reliable mechanical connection
Potting	No influence of potting compound on the connection	<ul style="list-style-type: none"> reliable connection between contact and PCB hole permanent connection without intersection, as of no socket terminal
Standoffs	Avoidance of standoffs	<ul style="list-style-type: none"> reliable mechanical connection

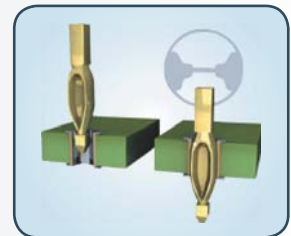

Reliable connections to PCB through Tcom press®

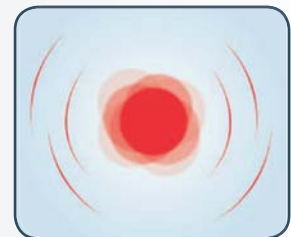

Resilient mechanical & electrical connection

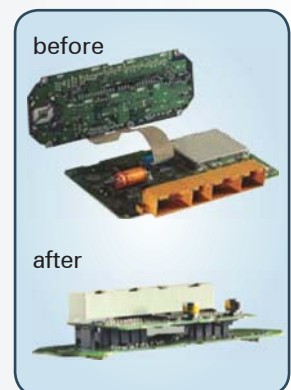

Small stacking height & space saving



Easy processing

Technical Specification

Technical Specification	flexilink _{b-t-b}	
	2.54 mm PCB connector	
Basics		
Number of pins	2 - 90	
Termination	Press-fit	
Board-to-board distance	5 - 25 mm	
Operating temperature range	-55°C to +125°C	
Material		
Insulator material	PBT	
Contact material	Copper alloy	
Contact surface	Sn	
Mechanical		
Pitch	2.54 mm or individually assembled	
Electrical		
Operational current	max. 8 A at 20°C per pin	
Clearance and creepage	0.4 mm / 0.57 mm (with 2.54 mm pitch)	
Processing		
Packaging	Bulk or Tray	
Assembly	manual / semi-automatic / fully automatic	
Approval		
UL file	E130314	
Environment	RoHS compliant	

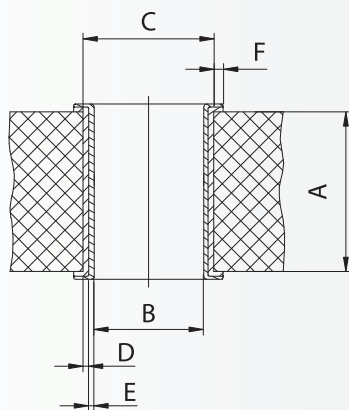

Plated through-hole according to IEC 60352-5

ept offers adapted press-fit zones for many PCB surfaces.

PCB Hole Specifications Press-fit

	PCB Hole Specification		
	Nominal Hole Ø 1.0 mm		
		imm. Sn printed circuit boards	Ni, Au printed circuit boards
A	PCB thickness	min 1.4 mm	min 1.4 mm
B	Plated hole	Ø 1.0 + 0.09 / - 0.06 mm	Ø 1.0 + 0.09 / - 0.06 mm
C	Drill hole	Ø 1.15 ± 0.025 mm	Ø 1.15 ± 0.025 mm
D	Cu plating	min. 25 µm	min. 25 µm
E	Plating	max. 1.5 µm imm. Sn	0.05 - 0.2 µm Au; over 2.5 - 5 µm Ni
F	Annular ring	min. 0.1 mm	min. 0.1 mm

flexilink_{jumper} - Horizontal PCB Connection in Press-fit

Reliable Connection for LED and more

ept's flexilink_{jumper} is a non-matable board-to-board connection for horizontal PCB assemblies.

A gap of 1 mm between the edges of printed circuit boards and a needed footprint of only 3.8 mm per pcb allows maximum utilization of board space and makes this connector suitable for many applications, e.g. "chaining" LED boards.

The height of the connector itself is only 2 mm. By selecting spacers this connector is suitable for all board thicknesses starting at 1 mm. The pins are designed for 1mm holes according to ept hole specifications.

The connector is available with 2 to 15 contact bridges. The distance between rows is 2 or 4 mm depending on the pin configuration.

Key Features:

- 11 A operational current
- small footprint design
- easy processing without soldering
- variable 2 or 4 mm pitch
- 2 - 15 contact bridges
- reliable connection through press-fit technology
- cost saving

Applications:

- LED
- shock & vibration
- PCB chaining

Termination



Press-fit

Mating configuration



Horizontal

Application



Power

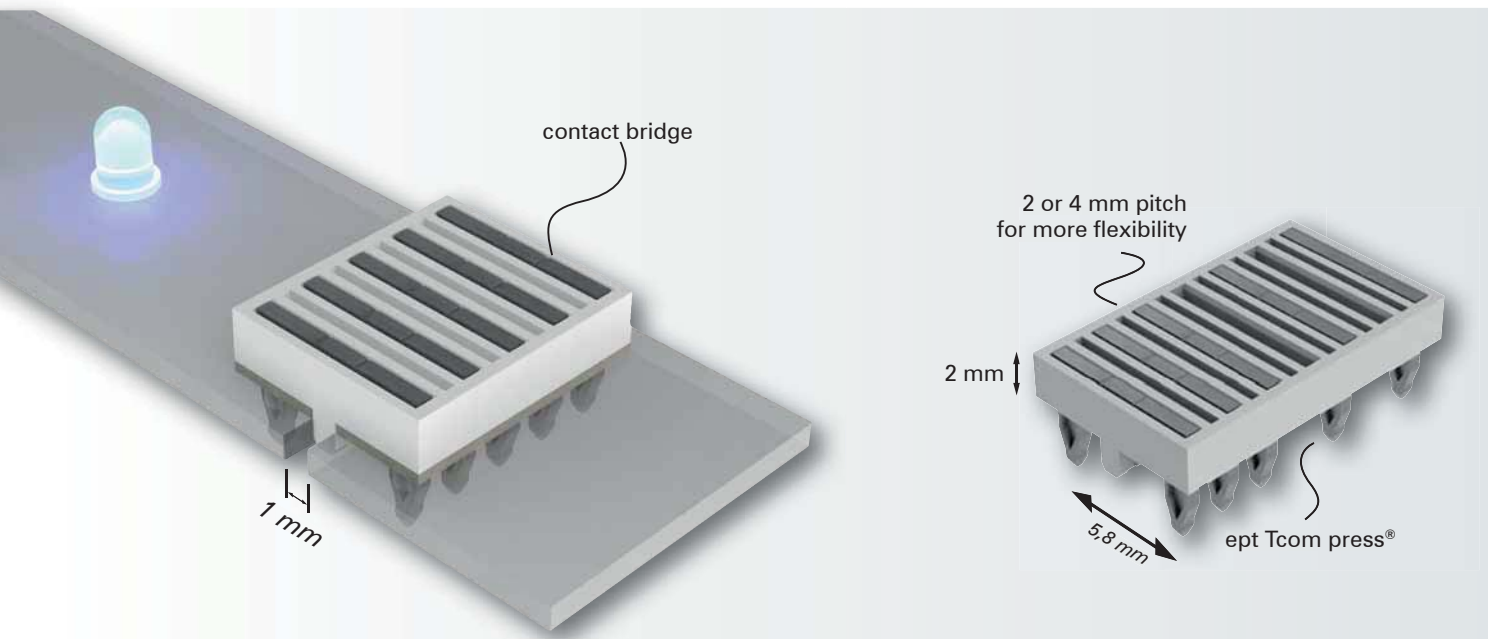

Processing Press-fit



The connector is placed at the desired position. The support tool ensures the correct alignment of the PCBs.



By using the lever of the press the connector is pressed-in with little effort. The press-fit zone absorbs the force through deformation.



The connection is gas tight and mechanically very strong. There's no need for an additional soldering of the component.

Technical Specification

Technical Specification	flexilink _{jumper}	
	Horizontal PCB connections with Tcom press®	
Basics		
Number of contact bridges		2 - 15
Termination		Press-fit
Operating temperature range		-55°C to +125°C
Material		
Insulator material		PBT glass filled
Colour insulator material		grey, RAL 7032 (other colours available)
Contact material		Copper alloy
Contact surface		Sn
Mechanical		
Pitch		2 / 4 mm
Electrical		
Operational current		11 A at 20°C (5 contact bridges) per pin
Contact resistance		≤ 5mΩ
Clearance and creepage		1.4 mm
Insulation resistance		≥ 10GΩ
Test voltage		1500 VDC
Approval		
UL file		E130314
Environment		RoHS compliant

Derating Diagramm

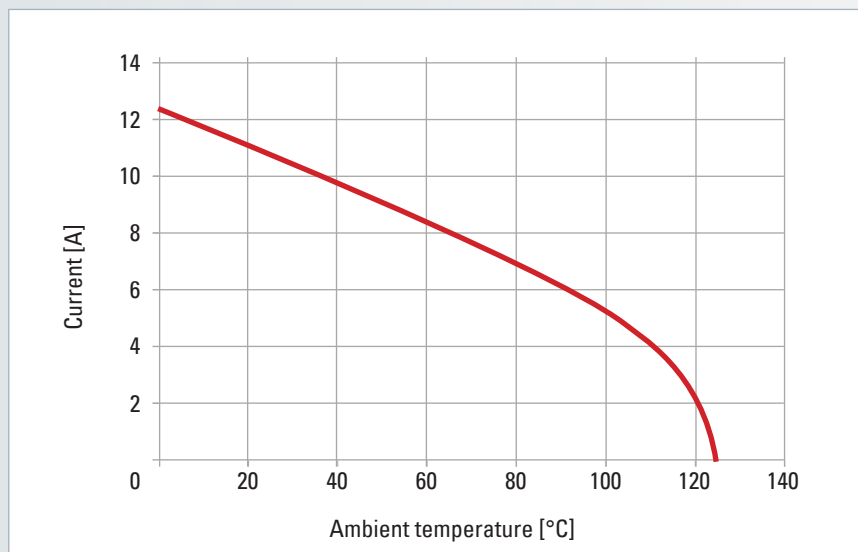

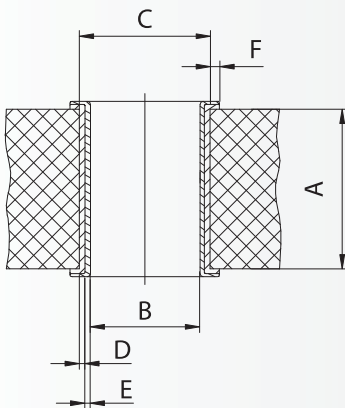

PCB Hole Specifications Press-fit

Plated through-hole according to IEC 60352-5

ept offers adapted press-fit zones for many PCB surfaces.

		PCB Hole Specification	
		Nominal Hole Ø 1.0 mm	
		imm. Sn printed circuit boards	Ni, Au printed circuit boards
A	PCB thickness	min 1.0 mm	min 1.0 mm
B	Plated hole	Ø 1.0 + 0.09 / - 0.06 mm	Ø 1.0 + 0.09 / - 0.06 mm
C	Drill hole	Ø 1.15 ± 0.025 mm	Ø 1.15 ± 0.025 mm
D	Cu plating	min. 25 µm	min. 25 µm
E	Plating	max. 1.5 µm imm. Sn	0.05 - 0.2 µm Au; more than 2.5 - 5 µm Ni
F	Annular ring	min. 0.1 mm	min. 0.1 mm

Horizontal PCB Connections

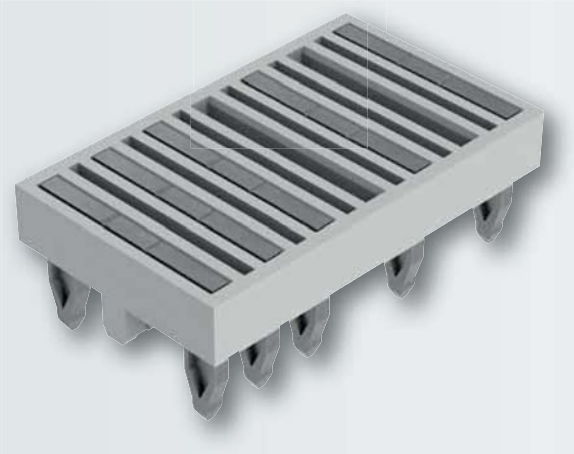

Type: non-pluggable bridge connector

Number of contact bridges: 2 to 15

Pitch: 2 mm or 4 mm

Operational current: 11 A at 20°C

Packaging: bulk

Standards:  

Technical Specification on page 32

For drawings and technical data visit www.ept.de

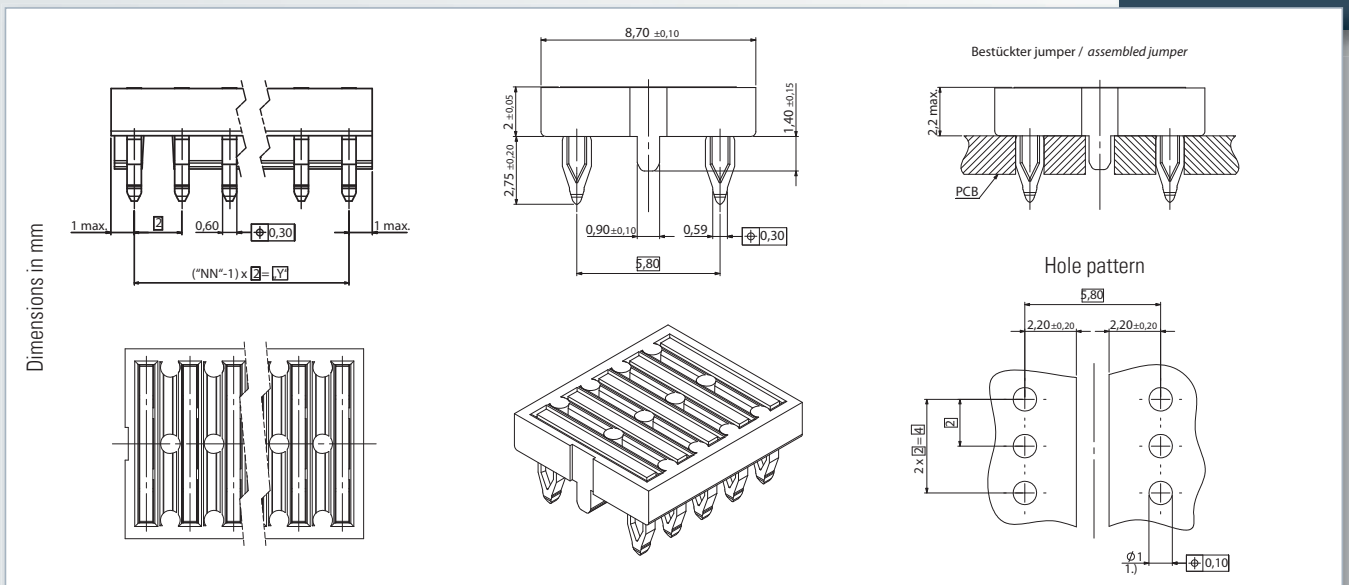

Couldn't find something suitable or having questions? We will be pleased to help you! Call us: +49 8861 / 25010.

Number contact bridges	Part number
2	991-500200-11
3	991-500300-11
4	991-500400-11
5	991-500500-11
6	991-500600-11
7	991-500700-11
8	991-500800-11
9	991-500900-11
10	991-501000-11
11	991-501100-11
12	991-501200-11
13	991-501300-11
14	991-501400-11
15	991-501500-11

flexilink_{jumper} with 2 contact bridges



On request

- other pin configurations

Colibri – 0.5 mm SMT for 10+ Gbit/s Applications

Connectors for COM Express®

ept's Colibri connector is a shielded, 2-row, SMT interconnect system in 0.5 mm pitch.

It is designed to meet the requirements according to specifications not only of PICMG COM Express®, but also of SFF-SIG Core Express® and nano-ETX-express and can be used for high-speed applications with 10 Gbit/s and more. Furthermore Colibri® products are compatible with all common connectors available on the market and extensively tested.

The connector system is available with 8 mm and 5 mm stacking height plus 220 and 440 pins. Colibri® connectors are packed in „Tape and Reel“ to allow fully automated processing.

Additional versions with flexible pin count as well as multiple stacking heights are available on request.

Key Features:

- for applications with 10+ Gbit/s
- meets the requirements of PICMG COM Express® and SFF-SIG CoreExpress®
- intermatability with available connectors in the market
- robust connector design
- integrated Pick & Place area
- packed in Tape & Reel

Applications:

- COM Express®
- CoreExpress®
- mezzanin board-to-board

Termination



SMT

Mating configuration



Parallel
5 or 8 mm

Application





High Speed

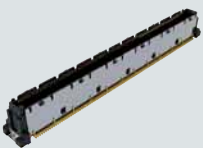

High Density

Overview

Type		Number of pins	Board type	Mating connector	Page reference
	Colibri Plug	220 / 440	COM Express® Base Board	Colibri Receptacle	40
	Colibri Receptacle	220 / 440	COM Express® COM Module	Colibri Plug	42

Your Com Express® Application needs more Speed? Colibri Connectors manage 10 Gbit/s and more!

Colibri connectors are specially designed for High Speed applications. Looking at the eye diagrams below, you can see that the connectors still show a very high signal quality at 10 Gbit/s compared to 8 Gbit/s. They are therefore highly suitable for High Speed applications with 10 Gbit/s and more.

8 Gbit/s, 2x50mm PCB trace length, 100Ω impedance, simulated according to PCIe Gen 3

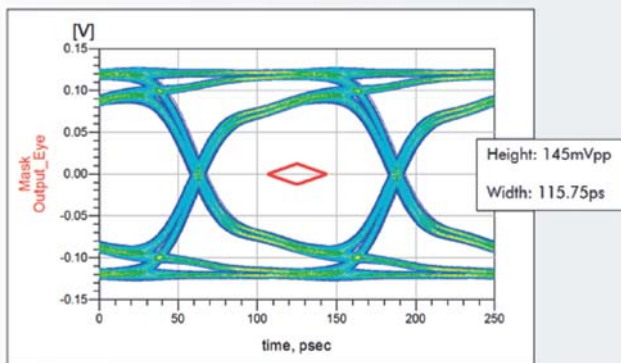

10 Gbit/s, 2x50mm PCB trace length, 100Ω impedance, simulated according to 10GBase-KR

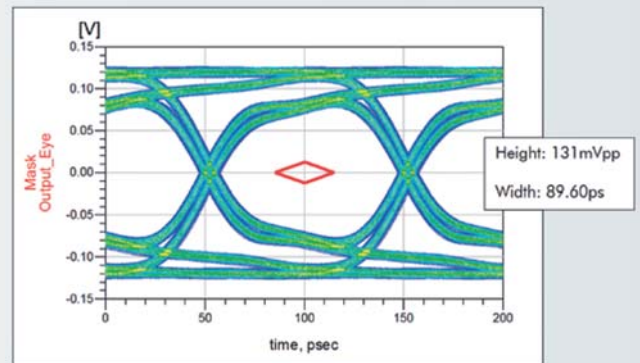

Differential Impedance of a Colibri Connector Set

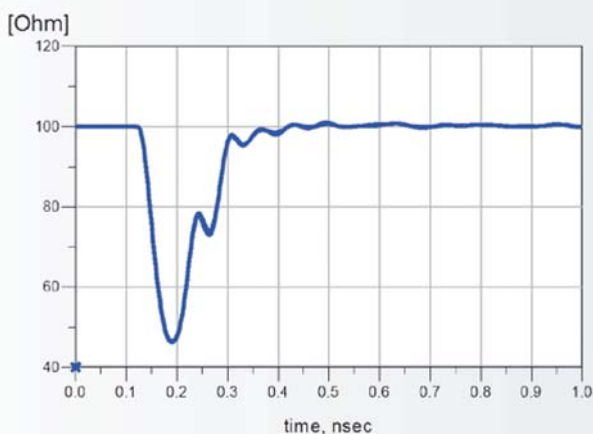

A differential signal was inserted into the plug side of the connector with a 25ps rise time.

A detailed report about the simulation with 10 Gbit/s as well as S-parameters for the simulation of your own design are available on request.

COM Express®

COM Express, a computer-on-module (COM) form factor, was developed and is maintained by PICMG (PCI Industrial Computer Manufacturers Group). The standard defines not only the physical dimensions and placement of the module on the carrier board, but also the connectors used to plug the COM with the carrier board. COM Express modules integrate the core functionalities of a bootable PC, such as

CPU, RAM and standard interfaces on a module that is plugged by either one or two connectors on an individually designed carrier board. ept's Colibri connectors are specified in the latest release of the PICMG Design Guide for COM Express.

The ability to plug a COM Express module onto a carrier board reduces time and cost to develop a product, as

the user does not need to understand the often complex details associated with high speed signaling or the latest chip sets. Furthermore, product lifetime can be increased, as newer COM Express modules can simply be plugged onto the carrier board to improve performance.

COM Express module sizes:

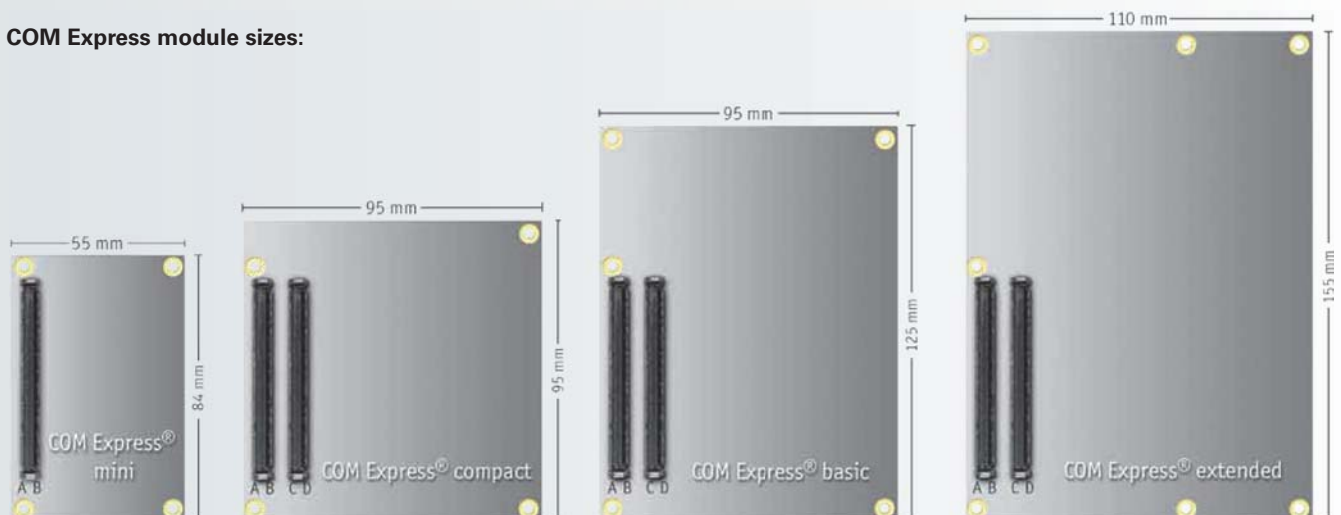

Typical applications:

- Industrial Automation
- POS-systems
- Medical
- Instrumentation
- Consumer electronics & Gaming
- Transportation
- Building Technology

Technical Specification

Technical Specification	Colibri® for COM Express®	
	0.5 mm SMT Board-to-Board connector system	
Basics		
Specification		PICMG COM.0
Number of pins		220 / 440
Termination		SMT
Operating temperature range		-40°C to +85°C
Material		
Insulator material		LCP, UL 94 V-0
Contact material		Copper alloy
Contact surface		Au over Ni
Mechanical		
Pitch		0.5 mm
Mating force per pin		max. 0.9 N
Separating force per pin		min. 0.1 N
Durability		30 mating cycles
Coplanarity		max. 0.1 mm
Electrical		
Operational current		max. 0.5 A
Operating voltage		50 VAC
Contact resistance		max. 75 mΩ
Insulation resistance		> 100 MΩ
Test voltage		200 VAC
Data transfer rate		10 Gbit/s
Processing		
Soldering temperature		260°C according to J-STD-020
MSL		1
Packaging		Tape and Reel or Tray
Assembly		Pick and place
Approval		
UL file		E130314
Environment		RoHS compliant

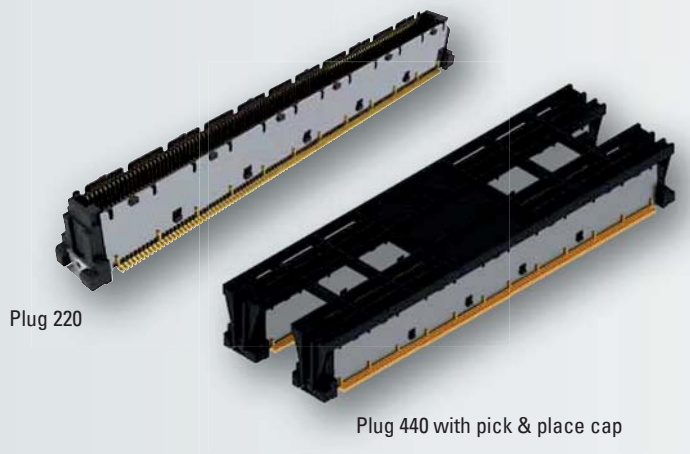

Type: Plug (Base Board)

Number of pins: 220, 440

Pitch: 0.5 mm

Data transfer rate: 10 Gbit/s

Packaging: Tape & Reel, Tray

Standards: PICMG COM.0



Technical Specification on page 39

For drawings and technical data visit www.ept.de

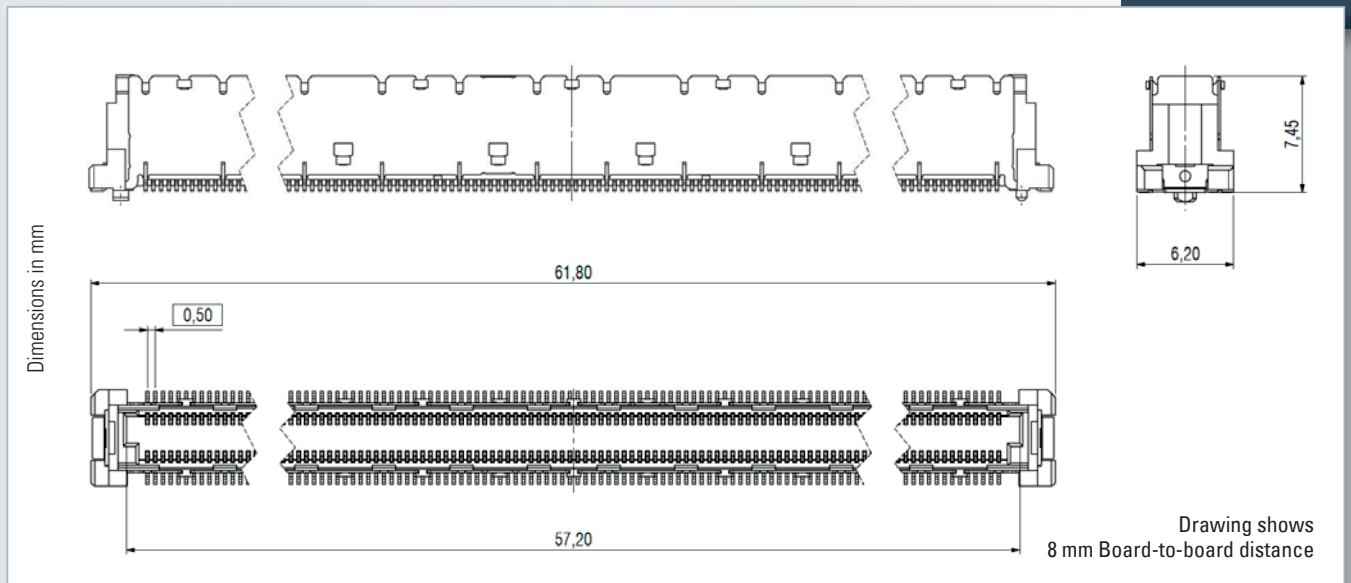

Mating connector / Application:



Colibri Receptacle (p. 42)



8 mm Board-to-board distance . . .

Number of pins	Colibri [®] Plug	
	Part number Tape & Reel	Part number Tray
220	401-55101-51	401-55101-51VP1
220 with pick & place cap	401-55151-51	401-55151-51VP1
440 with pick & place cap	401-55501-51	401-55501-51VP1

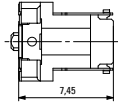

On request

- different number of pins
- other board-to-board distances
- alternative contact surface



5 mm Board-to-board distance . . .

Number of pins	Colibri [®] Plug	
	Part number Tape & Reel	Part number Tray
220	401-51101-51	401-51101-51VP1
220 with pick & place cap	401-51151-51	401-51151-51VP1
440 with pick & place cap	401-51501-51	401-51501-51VP1



On request

- different number of pins
- other board-to-board distances
- alternative contact surface

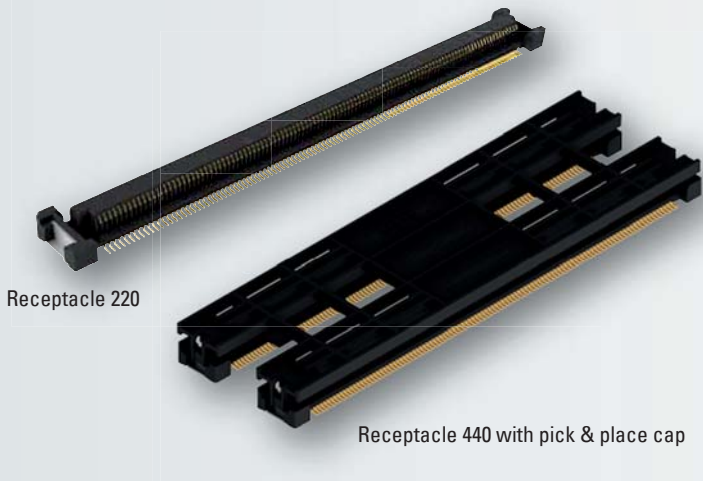

Receptacle 220

Receptacle 440 with pick & place cap

Type: Receptacle (COM Module)

Number of pins: 220, 440

Pitch: 0.5 mm

Data transfer rate: 10 Gbit/s

Packaging: Tape & Reel, Tray

Standards: PICMG COM.0



Technical Specification on page 39

For drawings and technical data visit www.ept.de

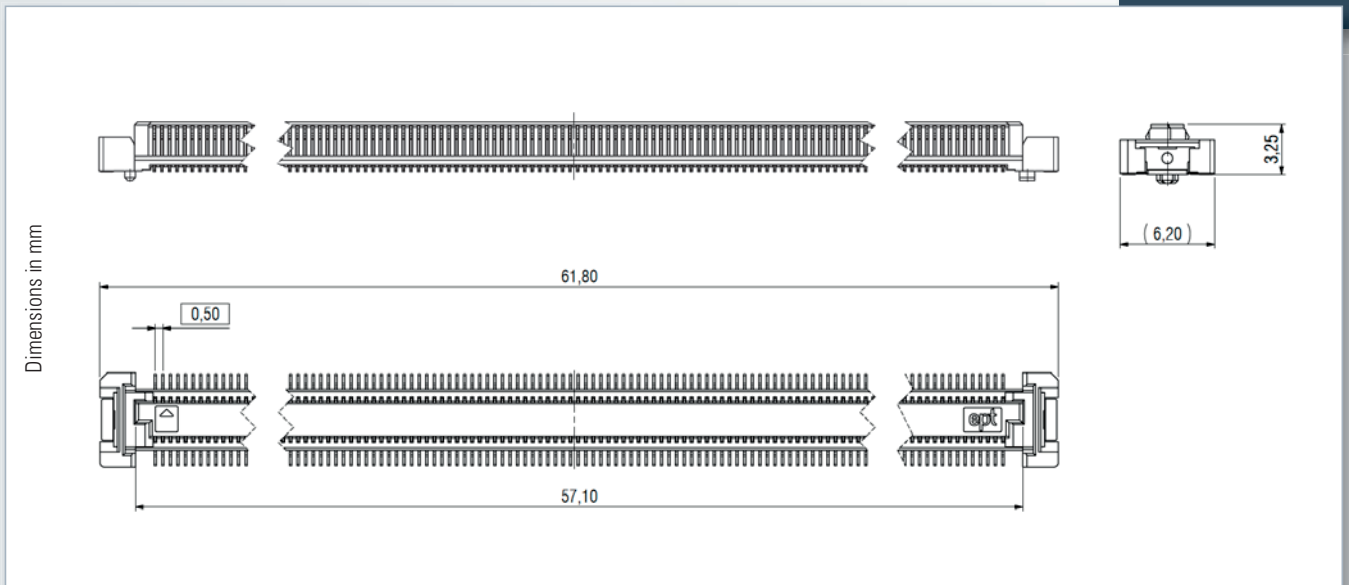

Mating connector / Application:

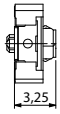

Colibri Plug 5 mm & 8 mm (p. 40)

Colibri [®] Receptacle		
		
Number of pins	Part number Tape & Reel	Part number Tray
220	402-51101-51	402-51101-51VP1
440 with pick & place cap	402-51501-51	402-51501-51VP1

On request

- different number of pins
- alternative contact surface

DIN 41612 / IEC 60603-2 – New Types in THTR

High Variety and well proven

Several new types with the termination technology THTR have now been added to ept's DIN 41612 connector family. As usual the standardization ensures that the connectors are compatible with products from different manufacturers.

Of course DIN 41612 connectors from ept are available in a range of termination technologies. Pre- and late mating contacts, pre-centering, board locks and coding keys provide developers and users with additional safety and a wide range of possible applications.

Key Features:

- a tried and proven connection system
- we also offer to perform special assembly for small batches
- supports pre-mating and late-mating contacts
- available in a variety of termination lengths
- a range of accessories, such as shrouds, board locks, coding keys

Applications:

- Backplane - Daughtercard, 19-inch Technology (VME)
- Board-to-Board, horizontal or parallel
- high current

Terminations



THTR

For further termination technologies please see ept catalogue or visit www.ept.de.

Mating configuration



Perpendicular



Horizontal



Parallel

Application



Power



Rugged

DIN 41612 - THTR – Product Overview

	Type		Pitch (mm)	max. no. of pins	Signal or Power	Termination	Mating connector
B	 B, B/2, B/3 Male		2.54	64 / 32 / 20	Signal 1.5 A	THTR	B, B/2, B/3 Q, Q/2 Female
	 B, B/2, B/3 Female		2.54	64 / 32 / 20	Signal 1.5 A	THTR	B, B/2, B/3 Q, Q/2 Male
C	 C, C/2, C/3 Male		2.54	96 / 48 / 30	Signal 1.5 A	THTR	C, C/2, C/3 R, R/2, R/3 Female
	 C, C/2, C/3 Female		2.54	96 / 48 / 30	Signal 1.5 A	THTR	C, C/2, C/3 R, R/2, R/3 Male
R	 R, R/2, R/3 Male		2.54	96 / 48 / 30	Signal 1.5 A	THTR	R, R/2, R/3 C, C/2, C/3 Female
	 R, R/2, R/3 Female		2.54	96 / 48 / 30	Signal 1.5 A	THTR	R, R/2, R/3 C, C/2, C/3 Male
F	 F Male		5.08 x 3.81	48	Power 5.6 A	THTR	F Female F Female low profile

For further types and termination technologies please see ept catalogue or visit www.ept.de.

THTR-Connectors from ept

As manufacturers move to one step solder process using reflow techniques, normal through hole components don't meet the temperature demands required.

ept is pleased to announce the introduction of our high temp DIN 41612 connector series, THTR. The connectors are designed to withstand reflow temperatures and be soldered in the same production batch as other surface mount components on the PCB. This eliminates the need for additional solder operations like wave solder or press-fit.

In the past, the SMT components had to be assembled and reflow soldered, before in an additional process step the connector had been pressed into the PCB. Now the male or female connectors are soldered fully automated with the other components in the standard SMT process.

ept connectors in THTR are made from a high temperature resistant plastic, which fulfils the requirements of J-STD-020D (Moisture/Reflow Sensitivity Classification for Nonhermetic Solid State Surface-Mount Devices).

In accordance with RoHS compliance specifications, ept's THTR connectors are suitable for any lead free reflow solder process and are rated to a temperature peak up to 260°C.

DIN connectors are widely used in many manufacturing environments with various termination methods to the PCB. ept also offers additional DIN 41612 connectors for electronic applications, including press-fit technology.

High Temp Connectors allow One Step Reflow Solder Process

THTR-Connectors from ept for easy and cost efficient manufacturing of PC boards.

THTR (Through Hole Technology Reflow) involves the following manufacturing steps:

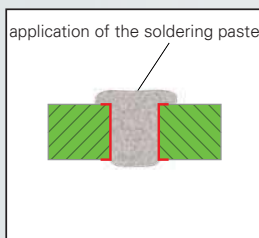

First, the solder paste is applied to the PCB. This is done either with a silk print process, a dispenser, or a solder preform.

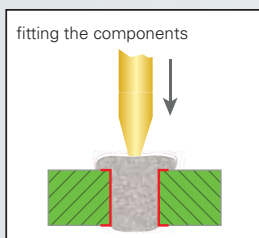

The SMD components are then placed onto the PCB. Finally, the connectors are placed into the holes, which are filled with solder paste.

In order to insure a quality reflow solder process, a uniform heat distribution is necessary to all solder locations.

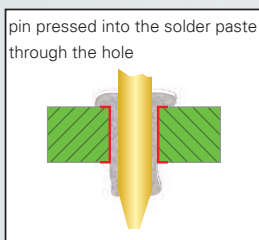

Although the connectors have a higher volume and mass as other SMT components, a longer solder time is not required. ept's high temp THTR connectors are as completely reliable as conventional wave solder connections. Additionally, all visual inspection requirements of the international standards are met.

Technical Specifications

Technical Specifications	DIN 41612 THTR-Connectors			
	B, B/2, B/3	C, C/2, C/3	R, R/2, R/3	F
Basics				
Standard	IEC 60603-2			
Number of pins	64/32/20	96/48/30		48
Contact row designation of male and female connectors	a b	a b c		z b d
Termination	THTR			
Operating temperature range	-55°C to +125°C			
Material				
Insulator material	PA glass filled, UL 94 V-0			
Mechanical				
Engaging and separating force for the complete, fully equipped connector	64 pol. < 60 N 32 pol. < 30 N 20 pol. < 18 N	96 pol. < 90 N 48 pol. < 45 N 30 pol. < 28 N		< 75 N
Separating force per contact (test measuring device)	> 0.15 N		> 0.2 N	
Durability according to DIN EN 60603-2 Performance level I Performance level II Performance level III	500 Mating cycles 400 Mating cycles 50 Mating cycles			
Electrical				
max. Operational current	1.5 A @ +20°C		5.6 A @ +20°C	
Contact resistance	< 20 mΩ		< 15 mΩ	
Clearance	1.2 mm		3.0 mm	
Creepage	1.2 mm		1.6 mm	
Insulation resistance	> 10 ⁶ MΩ			
Test voltage 50 Hz, 1 min				
contact/contact	1000 V		1550 V	
contact/ground	1550 V		2500 V	
Processing				
Packaging	Tube or Tray			
Soldering temperature	up to 260°C (depending on the way of soldering)			
Approval / Compliance				
UL file	E130314			
Environment	RoHS compliant			

DIN 41612 - THTR

Type B Male Connector



Type: Male connector 90° with 2 rows

Number of pins: 32, 64

Pitch: 2.54 mm

Operational current: 1.5 A

Standard: IEC 60603-2



Technical Specifications on page 47

For drawings and technical data visit www.ept.de

Dimensions in mm

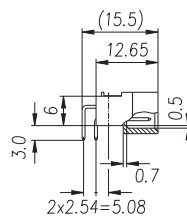
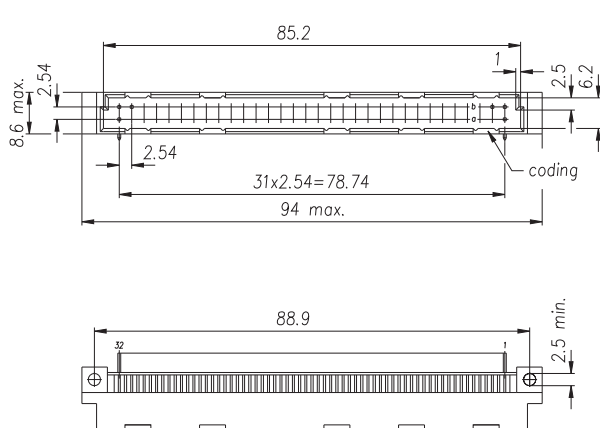

Hole pattern

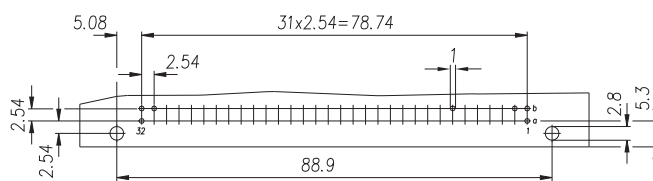

Drawing shows Type B Male Connector

Accessories

- Coding (see catalog)

Mating connector / Application:



Type B Female connector (p. 50)

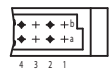
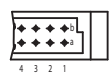

Type B Male connector - Performance level II

No. of pins	Contact arrangement	Termination length L 
		Part number
32		3.0 mm angled
		101-40024TH
64		101-40064TH

On request

- Performance level I + III or customized

Packaging

- Tube

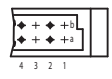
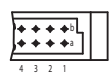

Type B/2 Male connector - Performance level II

No. of pins	Contact arrangement	Termination length L 
		Part number
16		3.0 mm angled
		101-90004TH
32		101-90014TH

On request

- Performance level I + III or customized

Packaging

- Tray

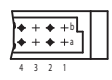
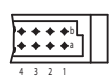

Type B/3 Male connector - Performance level II

No. of pins	Contact arrangement	Termination length L 
		Part number
10		3.0 mm angled
		101-80004TH
20		101-80014TH

On request

- Performance level I + III or customized

Packaging

- Tray

DIN 41612 - THTR

Type B Female Connector



Type: Female connector straight with 2 rows

Number of pins: 32, 64

Pitch: 2.54 mm

Operational current: 1.5 A

Standard: IEC 60603-2



Technical Specifications on page 47

For drawings and technical data visit www.ept.de

Dimensions in mm

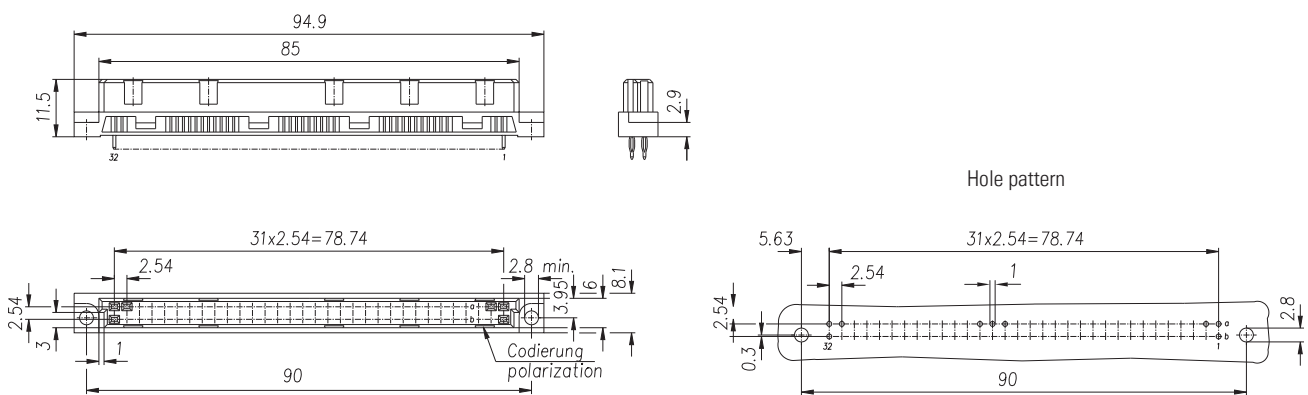

Drawing shows Type B Female Connector

Accessories

- Coding (see catalog)



Mating connector / Application:



Type B Male connector (p. 48)

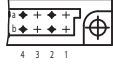

Type B Female connector - Performance level II

No. of pins	Contact arrangement	Termination length L 		
		2.5 mm	3.4 mm	4.6 mm
		Part number		
32		102-40024TH	-	-
64		302-40064-05TH	302-40064-01TH	302-40064-02TH

On request



- Performance level I + III or customized

Packaging

- Tube

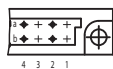

Type B/2 Female connector - Performance level II

No. of pins	Contact arrangement	Termination length L 	
		2.5 mm	4 mm
		Part number	
16		102-90004TH	102-90005TH
32		102-90064TH	102-90065TH

On request



- Performance level I + III or customized

Packaging

- Tray

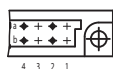

Type B/3 Female connector - Performance level II

No. of pins	Contact arrangement	Termination length L 	
		2.5 mm	4 mm
		Part number	
10		102-8004TH	102-8005TH
20		102-80064TH	102-80065TH

On request

- Performance level I + III or customized

Packaging

- Tray

DIN 41612 - THTR

Type C Male Connector

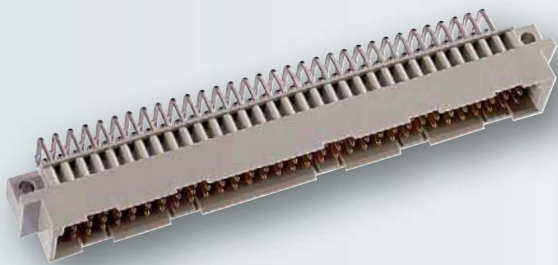

Type: Male connector 90° with 2 rows

Number of pins: 32, 48, 64, 96

Pitch: 2.54 mm

Operational current: 1.5 A

Standard: IEC 60603-2



Technical Specifications on page 47

For drawings and technical data visit www.ept.de

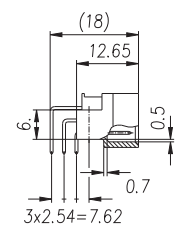
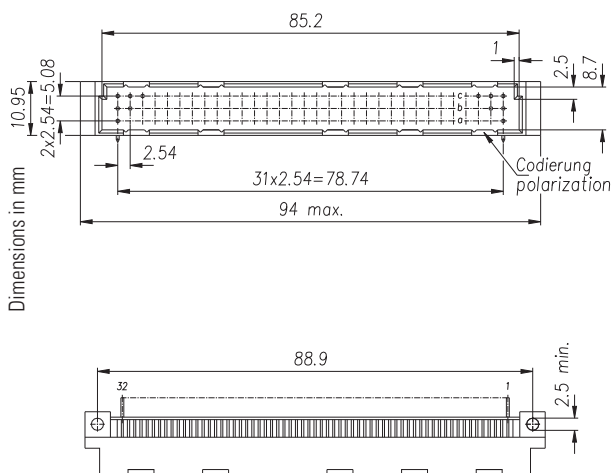

Hole pattern

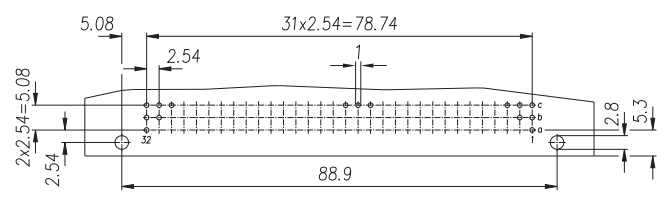

Drawing shows Type C Male Connector

Accessories

- Coding (see catalog)

Mating connector / Application:

Type C Female connector (p. 54)

Type R Female connector (p. 58)

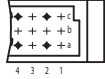
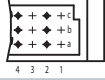
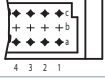
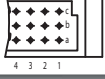

Type C Male connector - Performance level II

No. of pins	Contact arrangement	Termination length L 
		Part number
		3.0 mm angled
32		103-40014TH
48		103-40024TH
64		103-40034TH
96		103-40064TH

On request

- Performance level I + III or customized

Packaging

- Tube

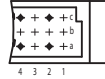
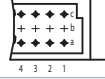
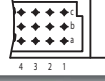

Type C/2 Male connector - Performance level II

No. of pins	Contact arrangement	Termination length L 
		Part number
		3.0 mm angled
16		103-90004TH
32		103-90014TH
48		103-90064TH

On request

- Performance level I + III or customized

Packaging

- Tray

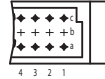
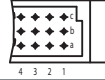

Type C/3 Male connector - Performance level II

No. of pins	Contact arrangement	Termination length L 
		Part number
		3.0 mm angled
20		103-80014TH
30		103-80004TH

On request

- Performance level I + III or customized

Packaging

- Tray

DIN 41612 - THTR

Type C Female Connector

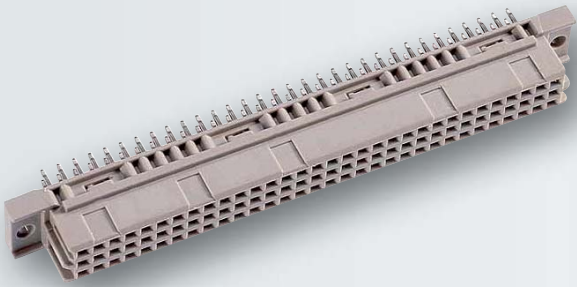

Type: Female connector straight with 2 rows

Number of pins: 32, 48, 64, 96

Pitch: 2.54 mm

Operational current: 1.5 A

Standard: IEC 60603-2



Technical specifications on page 47

For drawings and technical data visit www.ept.de

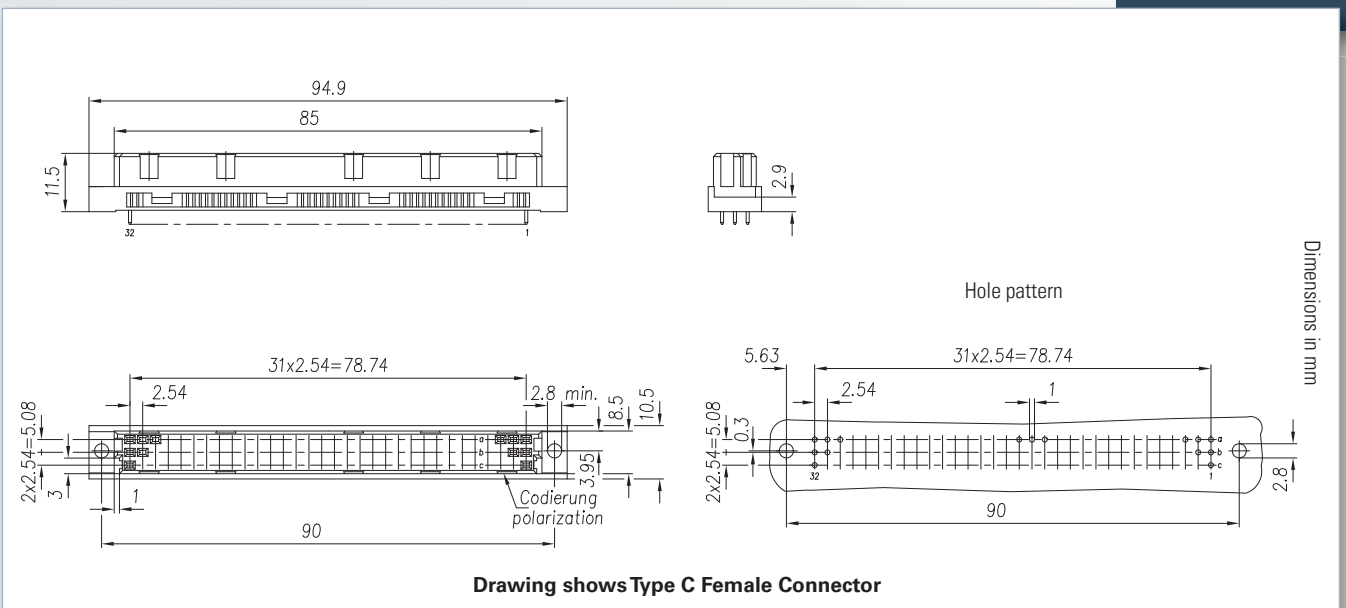

Accessories

- Coding (see catalog)

Mating connector / Application:

 Type C Male connector (p. 52)

 Type R Male connector (p. 56)

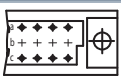
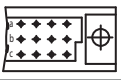

Type C Female connector - Performance level II

No. of pins	Contact arrangement	Termination length L 		
		2.5 mm	3.4 mm	4.6 mm
		Part number		
64		304-40054-05TH	304-40054-01TH	304-40054-02TH
96		304-40064-05TH	304-40064-01TH	304-40064-02TH

On request

- Performance level I + III or customized

Packaging

- Tube

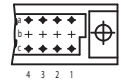
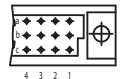

Type C/2 Female connector - Performance level II

No. of pins	Contact arrangement	Termination length L 		
		2.5 mm	3.4 mm	4.6 mm
		Part number		
32	 4 3 2 1	304-90014-05TH	304-90014-01TH	304-90014-02TH
48	 4 3 2 1	304-90064-05TH	304-90064-01TH	304-90064-02TH

On request

- Performance level I + III or customized

Packaging

- Tray

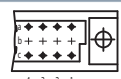
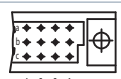

Type C/3 Female connector - Performance level II

No. of pins	Contact arrangement	Termination length L 		
		2.5 mm	3.4 mm	4.6 mm
		Part number		
20	 4 3 2 1	304-80014-05TH	304-80014-01TH	304-80014-02TH
30	 4 3 2 1	304-80064-05TH	304-80064-01TH	304-80064-02TH

On request

- Performance level I + III or customized

Packaging

- Tray

DIN 41612 - THTR

Type R Male Connector

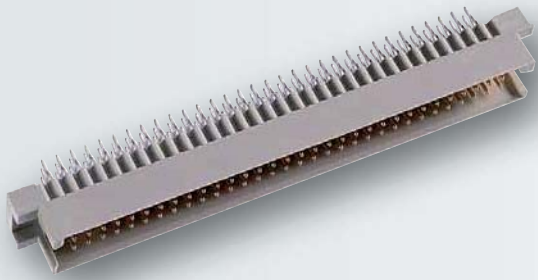

Type: Male connector straight with 3 rows

Number of pins: 32, 48, 64, 96

Pitch: 2.54 mm

Operational current: 1.5 A

Standard: IEC 60603-2



Technical Specifications on page 47

For drawings and technical data visit www.ept.de

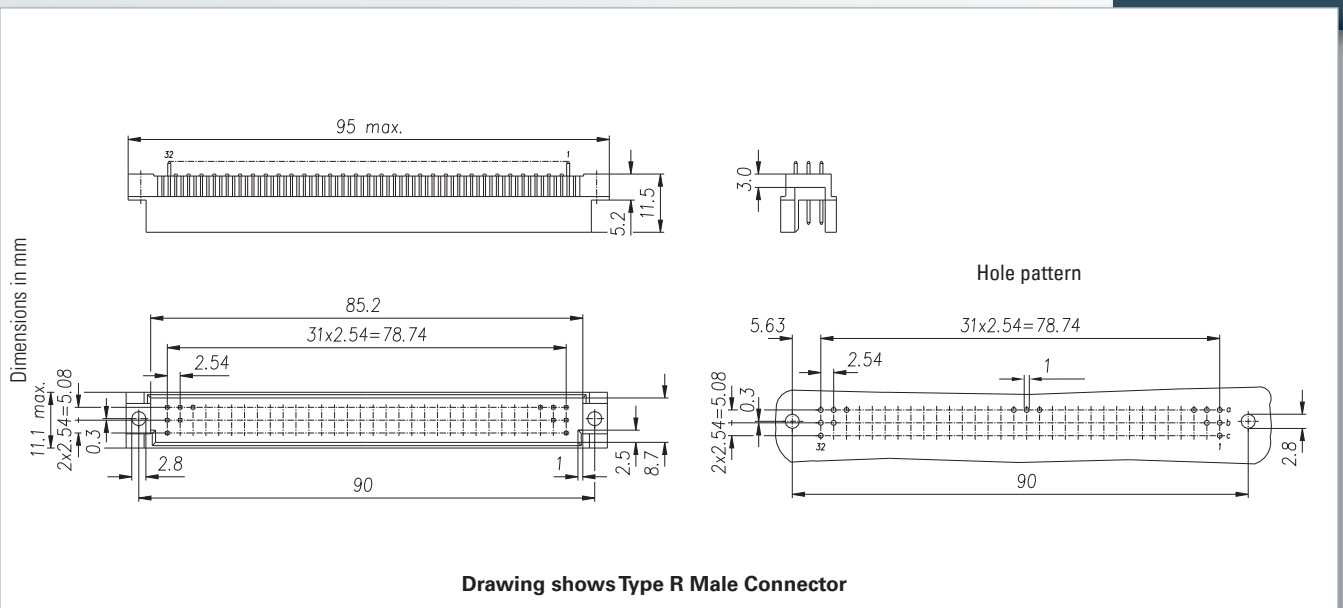

Mating connector / Application:

Type R Female connector (p. 58)

Type C Female connector (p. 54)

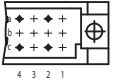
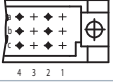
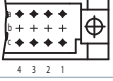
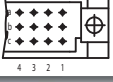

Type R Male connector - Performance level II

No. of pins	Contact arrangement	Termination length L 	
		2.5 mm	4 mm
		Part number	
32		115-40015TH	115-40046TH
48		115-40026TH	115-40025TH
64		115-40035TH	115-40054TH
96		115-40065TH	115-40074TH

On request

- Performance level I + III or customized

Packaging

- Tube

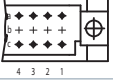
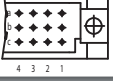

Type R/2 Male connector - Performance level II

No. of pins	Contact arrangement	Termination length L 	
		2.5 mm	4 mm
		Part number	
32		115-90014TH	115-90015TH
48		115-90064TH	115-90065TH

On request

- Performance level I + III or customized

Packaging

- Tray

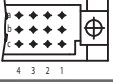

Type R/3 Male connector - Performance level II

No. of pins	Contact arrangement	Termination length L 	
		2.5 mm	4 mm
		Part number	
30		115-80064TH	115-80065TH

On request

- Performance level I + III or customized

Packaging

- Tray

DIN 41612 - THTR

Type R Female Connector

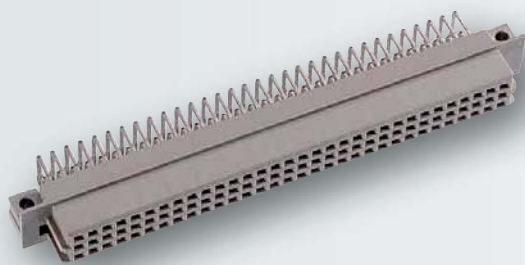

Type: Female connector 90° with 3 rows

Number of pins: 32, 48, 64, 96

Pitch: 2.54 mm

Operational current: 1.5 A

Standard: IEC 60603-2



Technical Specifications on page 47

For drawings and technical data visit www.ept.de

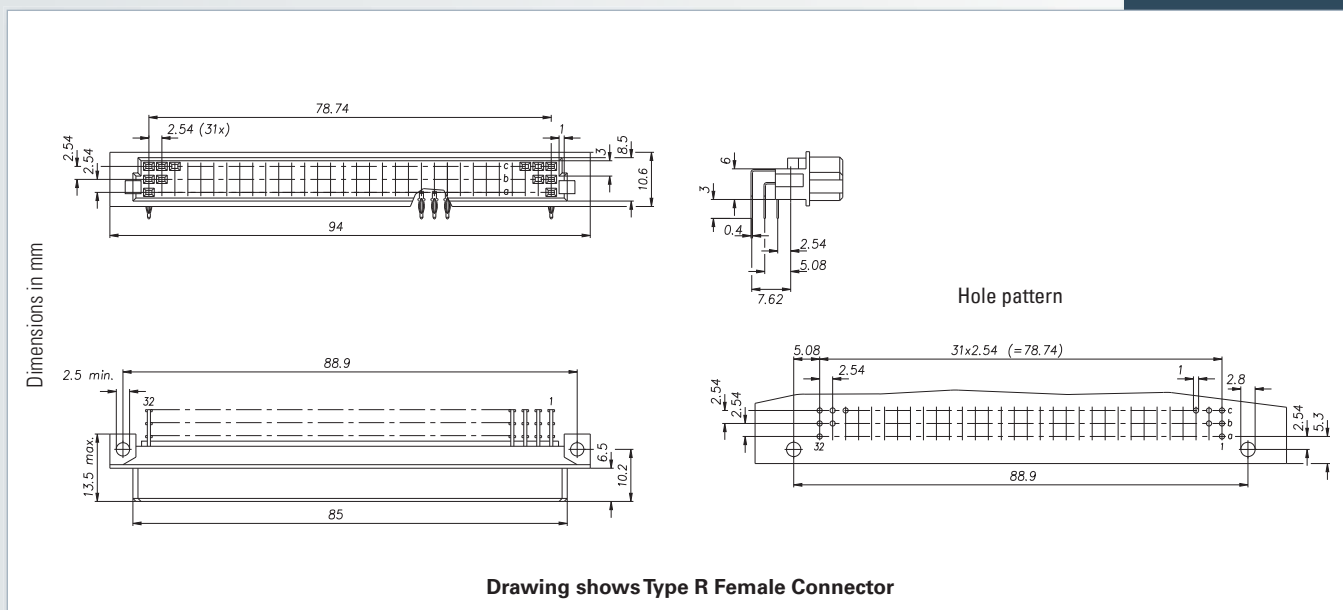



Mating connector / Application:

 Type R Male connector (p. 56)

 Type C Male connector (p. 52)

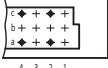
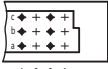
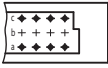

Type R Female connector - Performance level II

No. of pins	Contact arrangement	Termination length L 
		3.0 mm
		Part number
32		116-40034TH
48		116-40044TH
64		116-40054TH
96		116-40074TH

On request

- Performance level I + III or customized

Packaging

- Tube

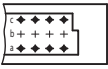
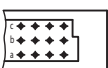

Type R/2 Female connector - Performance level II

No. of pins	Contact arrangement	Termination length L 
		3.0 mm
		Part number
32		116-90054TH
48		116-90064TH

On request

- Performance level I + III or customized

Packaging

- Tray

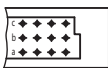

Type R/3 Female connector - Performance level II

No. of pins	Contact arrangement	Termination length L 
		3.0 mm
		Part number
30		116-80064TH

On request

- Performance level I + III or customized

Packaging

- Tray

DIN 41612 - THTR

Type F Male Connector

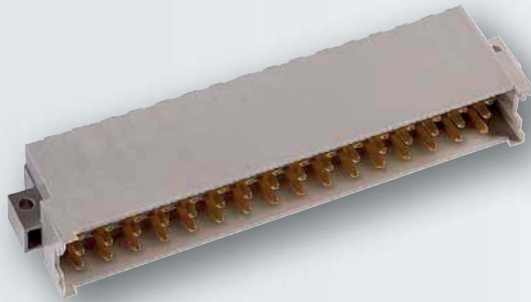

Type: Male connector 90° with 3 rows

Number of pins: 32, 48

Pitch: 5.08 mm x 3.81 mm

Operational current: 5.6 A

Packaging: Box

Standard: IEC 60603-2 **RoHS COMPLIANT**

Technical Specifications on page 47

For drawings and technical data visit www.ept.de

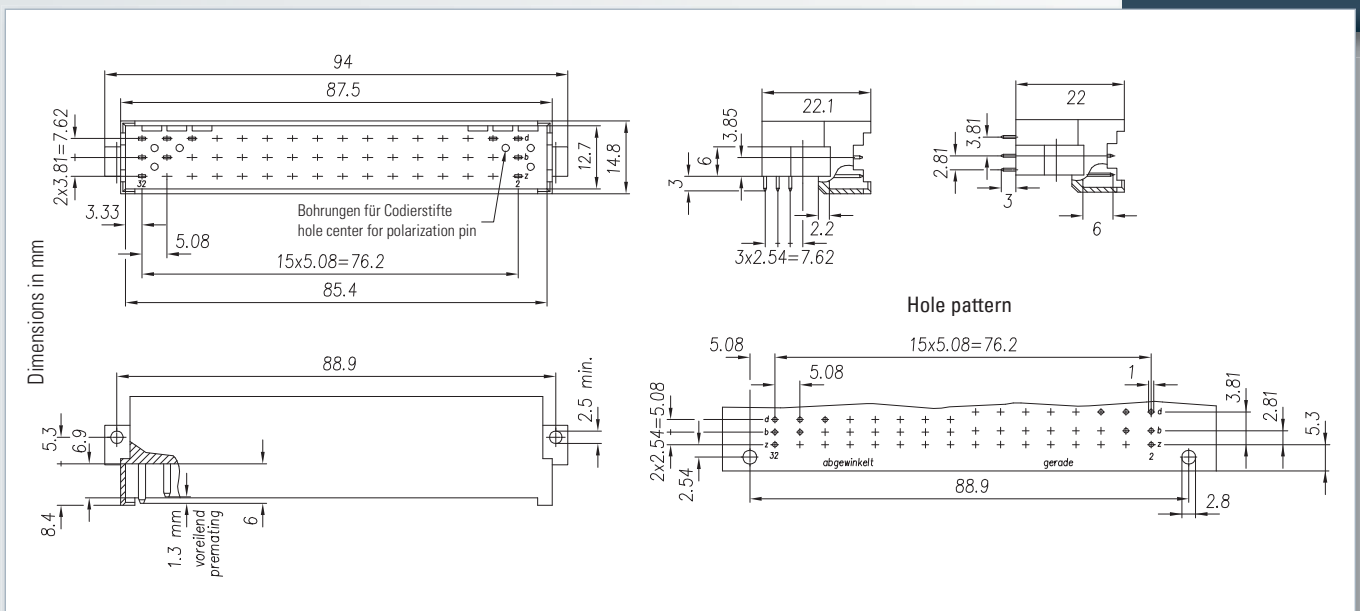

Accessories

- Coding (see catalog)

Mating connector / Application:







Type F Female connector (s. catalog)



Type F low profile Female connector (s. catalog)

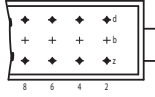
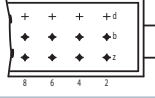

Type F Male connector - Performance level II

No. of pins	Contact arrangement	Termination length	
		 3 mm 3 rows angled	 3 mm 2 rows angled
Part number			
32		109-40014TH	-
32		-	109-40024TH
48		109-40064TH	-

On request

- Performance level I + III or customized

Packaging

- Box

DIN 41612 in NFF 16-101 / NFF 16-102 (EN 45545)

Connectors for Railway Technology

The standards NFF 16-101 and NFF 16-102 serve to classify the non-metallic materials which are used in rolling stock applications with regard to flammability, smoke development and toxicity in case of a fire.

The requirements for these connectors are derived from several factors such as the type of train, the frequency of tunnels it passes through and the mounting location of the connectors.

National standards like NFF 16-101/102, DIN 5510-2 or UNICEI 11170 will be replaced by the EN 45545 in March 2016.

Choose from a range of DIN 41612 / IEC 60603-2 connectors with insulator material that meets the high requirements of NFF 16-101 / NFF 16-102.

Key Features:

- highly rated classification I2 F1
- approved for rail car applications
- available for connectors as per DIN 41612 / IEC 60603-2
- reduced development time and simplified approval processes

Applications:

- railway
- traffic engineering

Termination



Press-fit



Through-Hole

Mating configuration



Perpendicular



Classification according to NFF 16-101 / NFF 16-102

Within NFF 16-101 / 102 ept's connectors are classified per flammability and smoke development:

Flammability		
I0	for I.O. ≥ 70	no inflammation at 960°C
I1	for I.O. 45 - 69	no inflammation at 960°C
I2	for I.O. 32 - 44	no inflammation at 850°C
I3	for I.O. 28 - 31	no afterburning at 850°C
I4	for I.O. ≥ 20	
NC	not classified	

Smoke emission	
F0	for I.F. ≤ 5
F1	for I.F. 6 - 20
F2	for I.F. 21 - 40
F3	for I.F. 41 - 80
F4	for I.F. 81 - 120
F5	for I.F. > 120

By combining both the result is shown in the diagram below:

	I0	I1	I2	I3	I4	NC
F0						
F1			X			
F2						
F3						
F4						
F5						

The white fields denote the combinations needed to meet aforementioned requirements.

Reduce your development time and simplify an intense approval process by using our range of connectors which are already approved for these applications. Talk to us about your connector applications.

Customized Connectors

Individually developed and produced

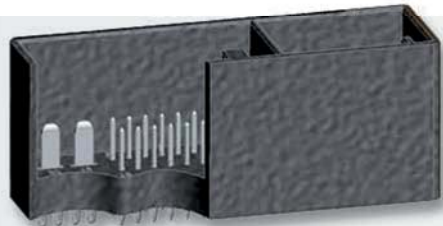

Male- & Female connectors in Press-fit, SMT, THR termination

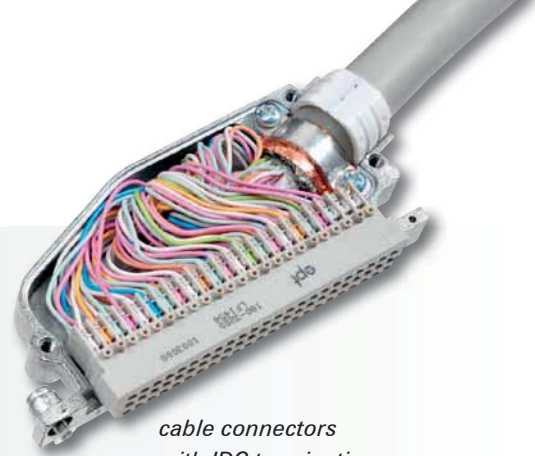

cable connectors with IDC termination

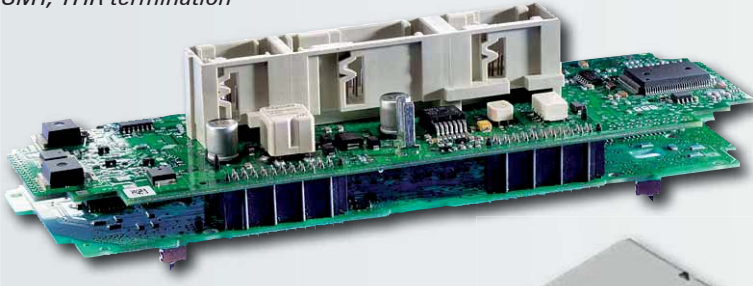

stamped terminal pins, sockets and shields

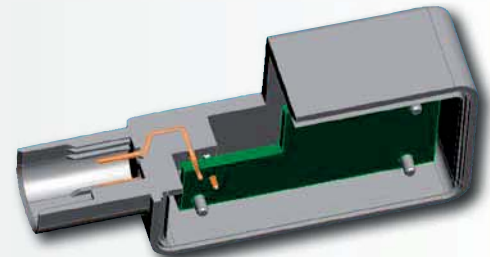

overmolded & potted connectors

"One Stop Supplier" for Customer Specific Connectors

Precision meets Passion

With its exceptional experienced employees, in-house tool-shop, and high vertical integration of manufacturing processes, ept is the perfect partner for customer specific connector solutions. Over the last 40 years, ept has proven to successfully develop and manufacture customized connectors in a variety of designs in different applications. ept's expertise is focused on stamped termination connectors, including examples of customized connector solutions such as shown above.

In-house from Your Request to SOP (Start of Production)

Starting with your request for a connection, ept's engineers are very experienced to develop a suitable, cost efficient and high quality product design. It is one of ept's major strengths to focus on a cost efficient design from the very beginning. In several projects we were able to reduce total cost of ownership up to 30% by adjusting the customers' original design for an optimized manufacturing process. Furthermore, cost efficiencies could be achieved by using already existing tools and equipment for customized applications.

ept's Project Managers follow a straight and targeted approach, based on the high requirements of APQP (Advanced Product Quality Planning) according to TS 16949. They make sure that deadlines are met, responses are given in short-notice, and possible problems are uncovered before you know of them. All required tools and equipment such as stamping dies, injection molding

Key features

- 40+ years of experience
- own Tool Shop
- fully vertical integration in manufacturing
- exceptional flexibility
- quick responsiveness
- cost efficiency
- excellent quality

Customized Connectors

Individually developed and produced



tools, assembling, inspection and packing equipment can be designed and made in ept's in-house tool shop. Hence, distances are short, response time is quick and, finally, reaction times on your requests are short. Furthermore, our in-house tool shop allows you to have functional prototypes available within 4 to 8 weeks after project kick-off.

Highest Quality and Flexibility over Lifetime

As in the development phase, ept is using an in-house approach during mass production of a program's life cycle. All production processes including stamping, reel-to-reel plating, molding, assembling, testing, and packaging are accomplished in-house and under ept's direct control. Hence, required changes to the product design and/or production process will be achieved quickly, smoothly, competent, and without disturbance of sub-suppliers. On top, and as ept is a family owned company with a flat hierarchy, you may escalate crucial requests easily even up to ept's owners.

With its 1.000 employees, ept operates manufacturing sites worldwide, such as in Germany, the Czech Republic, the USA, and China. Therefore, we can use the best suitable manufacturing location for your needs, such as local content requirements. Nevertheless and in any case, ept's passionate employees are dedicated to put quality and precision in first place of your valued project.

ept – Your Partner

Share your applications or connector ideas with us. We are happy to analyze your concept and provide you with a feasibility study and an initial cost estimation.



International presence - the ept locations

ept's roots are looked in the scenic landscape of southern Bavaria and from there ept has set out to become an international company. With production locations and sales offices in several countries as well as competent partners all

over the world, ept is able to offer its connectors and solutions worldwide.

ept – your global partner



For your local contact please refer to www.ept.de

connectors

ept designs, produces and distributes electronic connectors for highquality applications. Founded by Bernhard Guglhör over 40 years ago, we are proud to remain an independent and family owned company. Today, we employ 1.000 people at six locations worldwide.

Over decades we have built trusting and successful partnerships with our customers, who are the primary focus of all. Our products and core competencies are used in high-level applications.

With our motto "Precision with Passion" ept stands for the highest quality and reliability under the personal and individual touch of dedicated employees.

We are looking forward to working with you.
Your ept-Team

ept GmbH

Bergwerkstr. 50
86971 Peiting, Germany
Tel. +49 (0) 88 61 / 25 01 0
Fax +49 (0) 88 61 / 55 07
sales@ept.de

ept, inc.

805 Liberty Way
Chester, Virginia 23836, USA
Tel. +1 804 530 0820
800 323 2568
Fax +1 804 530 0837
sales@eptusa.com

ept Electronic Precision Technology (Shanghai) Ltd.

6F Building 37,
No. 333 Qin Jiang Road
Shanghai, P. R. China
Post code: 20 02 33
Tel. +86 (0) 21-54 26-09 88
Fax +86 (0) 21-64 95-39 49
sales@eptcn.com



www.ept.de