



Light Speed Vision (Beijing) Co., Ltd.
503 Block A, Singularity Center, Shahe Town
Changping District, Beijing , China 102206
Tel: +86(10)80709022-602 Web: www.qhyccd.com



QHYCCD

**Product Catalog
2020**



Blank Page

Inside Front Cover

Table of Contents

1. Introduction: The Company	2
2. Uncooled Series 5II CMOS Cameras - USB2.0	4
QHY5L-II-M	4
QHY5L-II-C	4
QHY5P-II-M	4
3. Uncooled Series 5III CMOS Cameras - USB3.0	6
QHY5III174M/C	6
QHY5III178M/C	6
QHY185C	6
QHY5III224C	6
QHY5III290M/C	6
4. Cooled Small Size CMOS Cameras [<1" Format, FSI and BSI Mono and Color CMOS Sensors]	8
QHY174M/C	8
QHY178M/C	8
QHY224C	8
QHY290C	8
QHY174M-GPS - New Product	10
5. Cooled Medium size CMOS Cameras [≥1" Format, FSI and BSI, Mono and Color CMOS Sensors]	12
QHY183M/C	12
QHY163M/C	12
QHY165C	12
QHY168C	12
QHY247C	12
QHY183M - New Product	14
QHY128C - New Product	16
QHY367PRO-C - New Product	16
QHY294C - New Product	18
QHY268C - New Product	20
6. Cooled Color CCD Cameras [Sony APS Format Color CCD Sensors]	22
QHY9	24
QHY10	24
QHY12	24
7. Cooled Mono and Color CCD Cameras [Sony Mono and True Sense Mono/Color CCD Sensors]	26
QHY9	26
QHY11	22
QHY21/22/23	24
QHY27/28/29	26
8. Cooled All-In-One Mono CCD Cameras with Built-In Filter Wheels	30
QHY695A/814A	30
QHY16200A	31
QHY16803A/9000A	32
9. Specialty Cameras	36
miniCam5F	36
miniCam6F - New Product	36
11. Filter Wheels and Accessories	38
QHYCFW3 - New product	38
PoleMaster	40
StarMaster	42
miniGuideScope	43
OAG	43
Adapters	44
12. Table of All QHY Camera Models	45
13. QHYCCD Founder Dr. Qiu	46
14. Contact Information	48

The Company



QHYCCD

Light Speed Vision (Beijing) Co., Ltd.

QHYCCD designs and manufactures high-performance scientific grade CMOS and CCD cameras. The QHY line of products include thermoelectrically cooled cameras, high-resolution scientific grade cameras, astronomical imaging cameras, digital X-ray machine DR cameras, and solar, industrial and laboratory cameras. The sensor arrays used in QHY cameras range from 400,000 pixels to more than 50 megapixels. Sensor format sizes range from 1/4 inch to medium format photography size (61mm diagonal), all with complete independent intellectual property rights. Most of the company's products are exported to the United States and Europe. The rich QHY product line is renowned for excellent performance and reliable quality. The company goal is to provide customers with first-class products and services.



PROFESSIONAL ASTRONOMY



QHYCCD, founded by [Qiu Hongyun, Ph.D.](#), produced China's first CCD cameras for astronomical observations in 2003 when the market was dominated by a relatively few manufacturers mostly based in the United States and in Europe. Since that time, however, a number of companies have made entry into the astronomical and scientific imaging market place. Despite the increased pressure of competition from established manufacturers, QHYCCD continued to develop and produce larger and more capable cameras contributing to its rise in popularity not only in China but also in the U.S. and Europe over the ensuing years. In less than 10 years, the QHY line expanded to about a dozen models. Today the

QHY product line includes over 40 different models and configurations including scientific cameras like the 50 Megapixel medium format CCD (61.3mm diagonal) QHY50 pictured at left. Satisfied QHY customers include the LAMOST Observatory (above right) with eight QHY45 cameras on the largest optical telescope in China (4 meters). The QHY45 CCD is 2K x 2K with 24 micron pixels and 70.1mm diagonal size. For other scientific and industrial use, work has just begun on a fast 29 Megapixel, 35mm format CCD based camera that will output multiple frames per second. Development is also underway on an E2V thinned back illuminated CCD camera for professional astronomy applications.

Unlike some companies that primarily offer one type of camera, either CCD or CMOS, QHYCCD has expertise in development of both types, large and small. Almost complete is a new QHY42 camera using a 2k x 2k back illuminated CMOS sensor with 11 micron pixels. This sensor delivers 95% peak quantum efficiency and only 1.3e- of noise with an output of 48 frames per second! For astronomy applications requiring long exposures, a smaller 2k x 2k sensor with 6 micron pixels and global shutter is planned that will appeal to astro-imagers. In beta test as this is written is the new QHY183M, a 20 Megapixel back illuminated monochrome CMOS camera with high QE and 15 FPS output expected to sell for around \$1000. The broad product line of QHYCCD, with cameras costing over \$40,000 to as little as \$99, means that there is a high quality scientific grade camera available for nearly any budget or application.

AMATEUR ASTRONOMY

As many amateur astronomers can testify, in the case of QHYCCD, affordable does not mean lower quality. QHY cameras have been used by amateurs for nearly 15 years with satisfaction and success. The first observatory established in China by and for amateurs is Xingming Observatory. Set up and managed by amateur Gao Xing, the observatory is housed at the Nanshan Station of Xinjiang Astronomical Observatory affiliated to the Chinese Academy of Sciences. The Nanshan site is about 75 km southeast of Ürümqi, a major city along the ancient Silk Road. There are about 280 observable nights per year, with median atmospheric seeing around 1.4". Established in 2007, the observatory offers online access to several telescopes and cameras and is currently conducting several scientific surveys including the NSP (nova search plan), CSP (the comet search plan) and SASP (supernovae and asteroids search plan) and various specialized sub-projects. Observations are carried out almost every clear night. In 2010, a half-meter telescope equipped with a QHY9 camera began running the SASP (Supernova and Asteroid Search Plan). This has since been



upgraded with a QHY16 camera. Within a few years, the program has found dozens of supernovae and nearly a hundred asteroids. "QHYCCD's biggest feature is the high cost (of competing products). "If you want to buy the same performance (in other products) some prices are twice as much as QHYCCD. And even compared to those products costing more than twice as much, QHYCCD is not inferior." Xingming Observatory has always been very keen on collaborations with other amateurs and professionals. The site is located in a longitude range with relatively few observatories, and so a significant effort has been devoted into time-domain observations. The Xingming facilities have participated in rapid follow-up of gamma-ray bursts (GRBs) detected by the Swift spacecraft as well as high frequency observations of asteroids and comets. [Note: If



you have any suggestions or comments, please contact: Ye Quan-Zhi at the California Institute of Technology (qye at caltech.edu) and/or Man-To Hui at the University of California at Los Angeles (pachacoti at ucla.edu)].

Many amateurs are performing research and contributing to science in the field of astronomy. However, unlike professionals, the vast majority of amateur astronomers, particularly in the United States and Europe, take images for aesthetic reasons rather than scientific research or discovery. Overwhelming evidence of the use of QHY cameras for aesthetic astro-imaging can be found on the QHY Flickr group. Although the group has been in existence only a few years, there are over 2,000 amateur images posted to this group alone, testifying to the capability of QHY cameras to engage in a wide range of imaging styles and applications. The extraordinarily low noise and high sensitivity of QHY CMOS cameras has made them the camera of choice for planetary imaging where stacking and processing numerous frames tremendously improves the image. Moreover, the same low noise cameras facilitate taking and combining shorter exposures of deep space objects to achieve similar results as a single long exposure. This makes it much easier to control guiding corrections and focus in each individual sub-frame and to discard a bad frame when necessary without losing an entire night's work.



SUMMARY

Whether you are a professional astronomer or an amateur, whether you are doing research or taking aesthetic images, whether you have a blank check from a well endowed foundation or are on a retiree's budget, QHYCCD has a solution that will help you. With 15 years of experience, QHY has the expertise to provide a quality product for just about any need.

QHY5-II Series USB 2.0 Guiding and Planetary Cameras



QHY5-II Series Cameras fit in a standard 1.25-inch eyepiece holder and have an adjustable location ring for confocality with an eyepiece. They are ideal for use as low-weight autoguider. QHY5-II series cameras come in very small but powerful packages! The improved thermal design allows the heat generated by the CMOS sensor to be transferred externally to the telescope's eyepiece tube.

QHY5L-II has high sensitivity and low noise (a highlight of the QHY5-II series). With an exceptional 74% QE, the QHY5L-II's sensitivity is even better than many CCD cameras. It is said that the QHY5L-II's image quality meets or exceeds that of ICX618-based cameras. The read noise is remarkably low (as few as 4 electrons). The sensor's on-chip FPN (Fixed Pattern Noise) calibration function solves one of the major problems of CMOS technology, resulting in images that are clear and uniform, even under high gain. With these advantages, the QHY5L-II provides outstanding image quality for planetary imaging, autoguiding, deep-sky and all-sky imaging. Available in both color and monochrome versions. The sensor has 1280 x 960 pixels at 3.75um and the camera is capable of 30 frames per second in high resolution mode, 106 FPS in VGA mode.

QHY5P-II has 5.0 megapixels. Available in both color and monochrome versions. The pixel size is 2.2um and the image sensor size is 1/2.5-inch. With its very high resolution, this camera is ideal for personal solar telescope imaging. Its 1.25-inch diameter allows it to be used in the eyepiece tube of a PST while solving the confocality issue common to them. The small pixel size provides high-resolution images even without a Barlow lens.

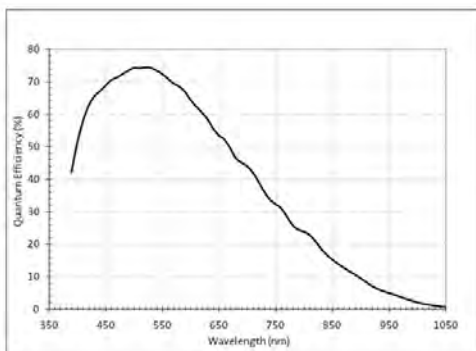

QHY5L-II-M QE

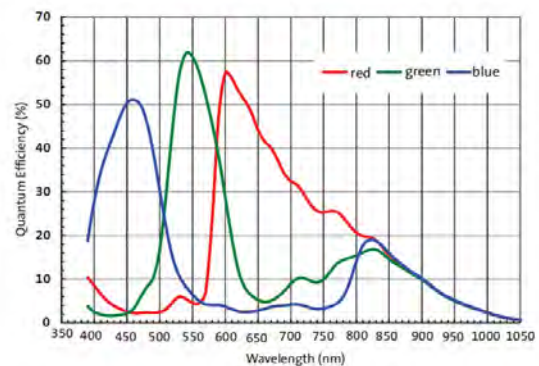

QHY5L-II-C

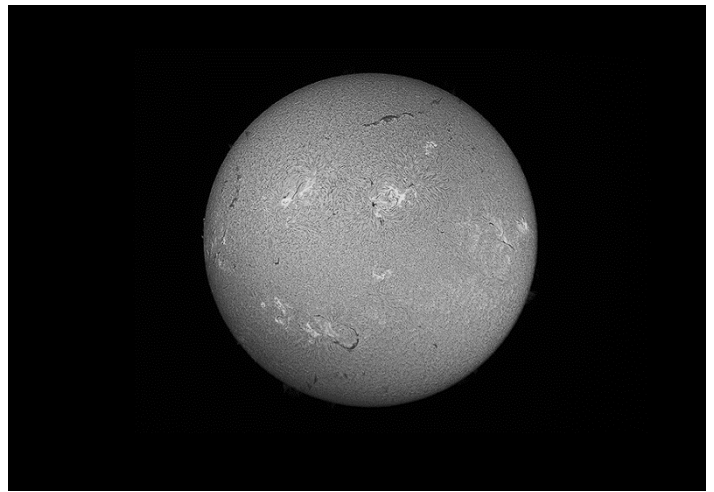
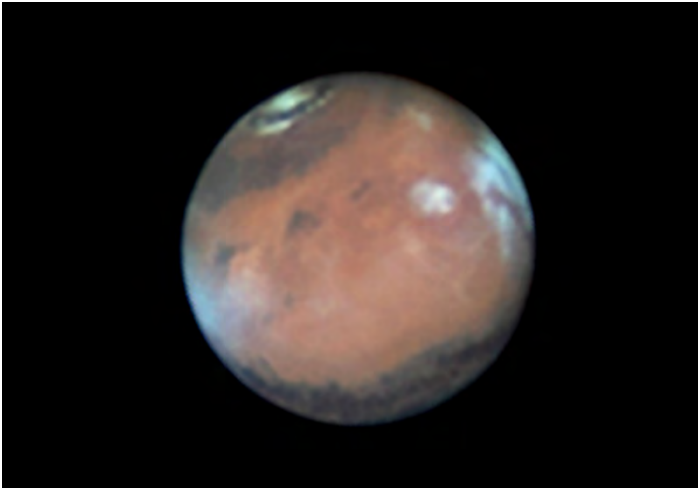

All images taken with QHY5L-II camera. Mars image courtesy Fábio and Gabriela Carvalho

Model	QHY5L-II-M	QHY5L-II-C	QHY5P-II-M
Sensor	MT9M034	MT9M034	MT9P006/P031
Total Pixels	1.2 Megapixels	1.2 Megapixels	5.0 Megapixels
Pixel Size	3.75um	3.75um	2.2um
Pixel Array	1280 x 960	1280 x 960	2592 x 1944
Optical Format	1/3 inch	1/3 inch	1/2.5 inch
FPS @ 640 x 480	106	106	63
FPS @ Full Resolution	30	30	7
Peak QE	74%	74%	63%
A/D Resolution	12-bit	12-bit	12-bit
Shutter	Electronic	Electronic	Electronic
Dynamic Range	>115 dB HDR Mode	>115 dB HDR Mode	67.74 dB
Weight	43g	45g	43g
Reference Price	Mono \$169	Color \$149	Mono \$299



QHYCCD

QHY5-III Series Planetary Imaging and Guide Cameras



The QHY5-III series cameras are USB3 super-speed cameras and guiders. They can be used in a standard 1.25-inch eyepiece holder and have an adjustable location ring for confocality with an eyepiece. QHY5-III series cameras have an internal memory capable of storing 10 to 1000 ROI frames of a star image for for analysis of exoplanet investigation, occultations, atmospheric seeing measurements, focus analysis, optics analysis, etc. The QHY5-III series cameras are small and powerful!

QHY5III174M/C uses the 2.3 Megapixel IMX174, 1/1.2-inch Exmor sensor with global shutter. Available in both monochrome and color. The large sensor size is a great choice for solar imaging, and the large pixel size and high QE (78%) makes it excellent for deep-sky imaging as well.

QHY5III178M/C uses the new 6.0 Megapixel IMX178 STARVIS Exmor R **back-illuminated** CMOS sensor. Available in both color and monochrome. With its small 2.4um pixels and 1/1.8-inch sensor size, the monochrome QHY5III178M is a superb guiding camera due to its advantages in resolution and wide FOV, plus its extraordinary sensitivity due to the STARVIS Exmore sensor. (STARVIS is Sony's designation for sensors that can record real time video in starlight).

QHY5III185C is a 1/1.9inch format, 1920 x 1200, USB 3.0, Color CMOS Camera with ultra-high sensitivity and very low read noise. The pixel size is 3.75um x 3.75um. Maxium Frame rate is 100FPS @ full resolution. The CMOS sensor is a SONY IMX185 noted for its very good SNR1 score

QHY5III224C uses the IMX224 sensor (available in color only). With its extremely-low readout noise of less than one electron, the IMX224 sensor achieved the top score in the new SNR1 index proposed by Sony for picture quality at low illumination. It is one of your best choices for color planetary imaging.

QHY5III290M/C uses the IMX290 STARVIS Exmor R **back-illuminated** CMOS sensor. Available in both color and monochrome versions. Extremely low read noise. 1920x1080 full-HD resolution. 1/2.8-inch sensor size. This might be the highest-sensitivity sensor from Sony with such a small pixel size. The QHY5III290M can be regarded as the next generation in monochrome planetary cameras after the QHYCCD QHY5L-II-M.

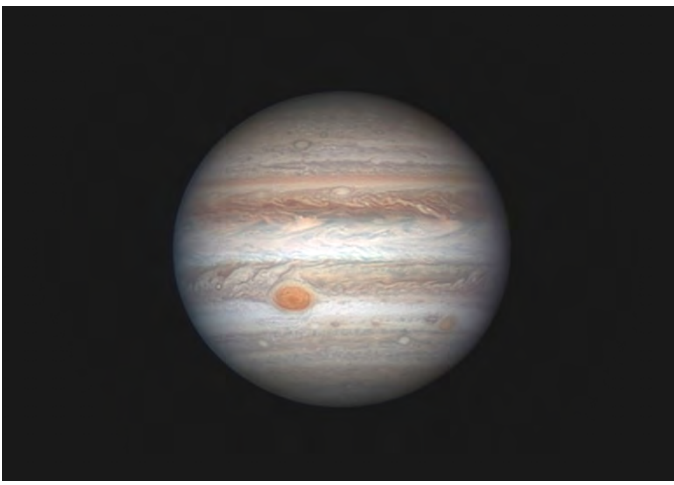

Jupiter Image QHY5III-290M, Courtesy Christopher Go
M51 Image QHY5III-174M, Courtesy Alberic De Bonnevie

NGC4631 Image QHY5III-174M, Courtesy Alberic De Bonnevie
Mars Image QHY-290M, Courtesy Jack

“The QHY5-III-290M camera is so low noise and more sensitive that I could reduce my capture time. I can finish my session in 15 minutes with superior images vs 45 minutes before!” — Chris Go.

Model	QHY5III-174M/C	QHY5III-178M/C	QHY5III-185C	QHY5III-224C	QHY5III-290M/C
Sony Sensor	IMX174 Exmor CMOS	IMX178 STARVIS Exmor R CMOS	IMX185 Exmore CMOS	IMX224 Exmor CMOS	IMX290 STARVIS Exmor R CMOS
Illumination	Front Illuminated	Back Illuminated	Front Illuminated	Front Illuminated	Back Illuminated
Total Pixels	2.3 Megapixels	6.3 Megapixels	2.3 Megapixels	1.2 Megapixels	2.0 Megapixels
Pixel Size	5.86um	2.4um	3.75um	3.75um	2.9um
Pixel Array	1920 x 1200	3072 x 2048	1920 x 1200	1280 x 960	1920 x 1080
Optical Format	1/1.2-inch	1/1.8-inch	1/1.9-inch	1/3-inch	1/2.8-inch
FPS @ ROI	490@480x300	190@764x512	413@320x240	557@320x240	460@480x270
FPS @ Full Resolution	138FPS	50FPS	96FPS	150FPS	135FPS
Shutter	Electronic (Global)	Electronic	Electronic	Electronic	Electronic
A/D Resolution	12-bit	14-bit	12-bit	12-bit	12-bit
Read Noise	1.6e- to 5.3e-	0.9e- to 2.4e-	1e- to 4e-	0.5e- to 3e-	0.75e- to 3.2e-
Full Well Capacity	32ke-	15ke-	TBD	19ke-	>15.7ke-
Weight (M/C)	89g / 85g	86g / 87g	86g	86g	86g / 87g
Reference Price (M/C)	\$629 / \$599	\$429 / \$399	\$379	\$369	\$429 / \$399

Please note prices are subject to change without notice, please check with QHYCCD or your dealer for current prices



QHYCCD

QHY Cooled Small Size CMOS Cameras QHY174/178/224/290



The QHYCCD Small "COLDMOS" camera series includes all of our cooled cameras with BSI (back-illuminated) and FSI (front-illuminated) CMOS sensors in optical format sizes smaller than 1 inch. These same sensors are also used in the uncooled QHY5III Series cameras. All Small COLDMOS cameras can internally record and store up to 1000 frames of a star image ROI (Region of Interest) for analysis of exoplanet investigation, occultations, atmospheric seeing measurements, focus analysis, optics analysis, etc.

- USB 3.0
- Regulated TE Cooling Delta -40C
- 128 MB DDR Frame Buffer
- ST-4 Compatible Guide Port
- Filter Wheel Port
- Anti-Noise Technology
- Anti-Amp Glow Technology
- Anti-Dew Technology

These additional features include a heated optical window to prevent external dew, a desiccant plug socket to help maintain a frost-free CMOS chamber, a 128MB frame buffer, a filter wheel port, and in the case of the QHY174M-GPS (Selected by the NASA New Horizon Team), an optional GPS timing module for highly accurate time stamping on individual frames. Dual-stage TE cooling reduces the sensor temperature to -40C or more below ambient and temperature regulation maintains a constant temperature set point. Due to the efficient TE cooling, single exposure times up to 30 minutes are possible on most models, making them suitable for deep space imaging of dim objects as well as brighter objects and planets.

All of the Small COLDMOS cameras use Sony Exmor CMOS sensors. Two models, the QHY178 and QHY290, use Sony STARVIS Exmore R back-illuminated sensors. STARVIS is Sony's designation for sensors capable of recording under starlight. These sensors have improved sensitivity and noise reduction - the key factors to enhancing image quality, while radically realigning their fundamental pixel structure from front-illumination to back-illumination. It retains the advantages of CMOS image sensors such as low power consumption and high-speed operation while dramatically improving sensitivity. With a conventional front-illumination structure, the metal wiring and transistors on the surface of the silicon substrate that form the sensor's light-sensitive area (photo-diode) impede photon gathering carried out by the on-chip lens, and this has also been an important issue in the miniaturization of pixels and widening optical angle response.



Saturn Image QHY-290M, Courtesy Christopher Go

Model	QHY-174M/C	QHY-178M/C	QHY-224C	QHY-290M/C
Sensor	Sony IMX174 Exmor CMOS	Sony IMX178 STARVIS Exmor R CMOS	Sony IMX224 Exmor CMOS	Sony IMX290 STARVIS Exmor R CMOS
Illumination	Front Illuminated	Back Illuminated	Front Illuminated	Back Illuminated
Total Pixels	2.3 Megapixels	6.3 Megapixels	1.2 Megapixels	2.0 Megapixels
Pixel Size	5.86um	2.4um	3.75um	2.9um
Pixel Array	1920 x 1200	3072 x 2048	1280 x 960	1920 x 1080
Optical Format	1/1.2-inch	1/1.8-inch	1/3-inch	1/2.8-inch
Shutter	Electronic (Global)	Electronic	Electronic	Electronic
Exposure Time	50us - 1800sec	50us - 1800sec	7us - 400sec	50us - 1800sec
FPS @ Full Resolution	138FPS	50FPS	150FPS	135FPS
FPS @ ROI	490@480x300	190@764x512	557@320x240	460@480x270
A/D Resolution	12-bit	14-bit	12-bit	12-bit
Read Noise	3e- to 5e-	0.9e- to 2.4e-	0.55e- to 3e-	0.75e- to 3.2e-
Full Well Capacity	32ke-	15ke-	19ke-	15ke-
Cooling Delta	-40C Regulated	-40C Regulated	-40C Regulated	-40C Regulated
Computer Interface	USB 3.0	USB 3.0	USB 3.0	USB 3.0
Weight (Mono/Color)	450g	450g	450g	450g
Reference Price (Mono/Color)	\$939 / \$899	\$769 / \$699	\$669	\$729 / \$699
w/GPS (Cooled/Uncooled)	\$1239 / \$939	N/A	N/A	N/A

Please note prices are subject to change without notice, please check with QHYCCD or your dealer for current prices



QHYCCD

QHY174M-GPS

Time Domain Imager with GPS PPS Synced High Precision Hardware Stamp



The QHY174M-GPS camera is the same as the QHY174M but with the addition of an optional GPS based precision time and location function, useful for imaging occultations, eclipses, meteors, and other scientific imaging requiring a highly precise recording of the time and location of the observation on every frame. The QHY174M-GPS has dual stage TE cooling to -45C below ambient with full anti-moisture control including heated optical window and removable desiccant plug for the sensor chamber. The camera has our 4-pin QHYCFW2 filter wheel control port and a 6-pin autoguider port. The QHY174 also has an anti-amp glow function. It can reduce the IMX174 sensor's amplifier glow significantly in long exposures. The IMX174 sensor has a global shutter and is capable of high frame rates, both ideal features for a time-domain imaging camera. The QHY174M-GPS will record the global shutter exposure starting and ending time with microsecond precision. Two QHY174 cameras, for example, each located anywhere in the world, can have the same time base, accurate to microseconds. In order to guarantee the starting and ending time of the exposure, the QHY174 has a built-in LED pulse calibration circuit precise to 1 microsecond.

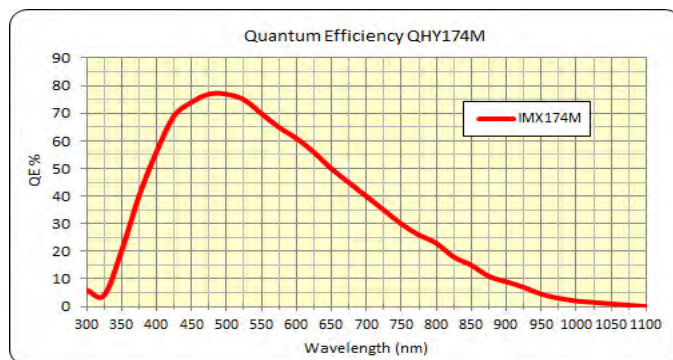

LED Cal	AUTO	AUTO
FPS:141		
LAT:400201832		
LON:116197653		
TA:2016/2/11 10:09:23.769486		
TB:2016/2/11 10:09:23.776760		
TN:2016/2/11 10:09:23.776760		
DT:0sec72734us		
NUM:544174		
GPS STATU	3	3

The QHY174 camera is designed to be an excellent planetary, lunar, solar and meteor capture video camera. With a 50mm F1.4 lens it will record mag 8 to mag 9 stars in live video recording at 30FPS (33ms exposure), several magnitudes fainter than can typically be seen with the naked eye. The QHY174M-GPS can internally record and store up to 1000 frames of a star image ROI for analysis of exoplanet investigation, occultations, atmospheric seeing measurements, focus analysis, optics analysis, etc.

Master mode: In Master Mode, the camera is free running and the internal 10MHz GPS synced clock will measure and record the shutter's opening and closing time. Slave mode: In Slave Mode you can input a target start time and the interval period for two frames. For example: You want three cameras in different locations (maybe thousands of kilometers apart) to start an exposure at 2016.3.9.UTC 14:00:00.000000 and then to continue with exposures at the interval time of 0.100000 sec. After you input these values, all the three

cameras will wait until this time and then simultaneously start video recording. The time stamp and other GPS information is embedded into the image. The software decodes it in real time and displays the information on left. Since the data is embedded, it will never be lost so long as you keep the original image.



QHYCCD

QHY174M-GPS

Selected by the NASA New Horizons Team



Now that the New Horizons spacecraft has flown beyond the orbit of Pluto, its next target will be MU69, the most distant object ever imaged remotely by a spacecraft. To make the flyby of MU69 a success, preliminary observations were needed to determine its approximate shape and exact orbit. Such a measurement from Earth required precise timing of exposures taken by multiple observers during an occultation that would last at most 2-3 seconds. The QHY-174M-GPS cameras selected by NASA provided highly accurate timing of multiple exposures per second at 5 different sites, all synchronized to the same time base, enabling an estimate of the unusual shape of the distant object. See: <https://www.nasa.gov/feature/nasa-s-new-horizons-team-strikes-gold-in-argentina>

"This effort, spanning six months, three spacecraft, 24 portable ground-based telescopes, and NASA's SOFIA airborne observatory was the most challenging stellar occultation in the history of astronomy, but we did it!" said Alan Stern, New Horizons principal investigator from SwRI.

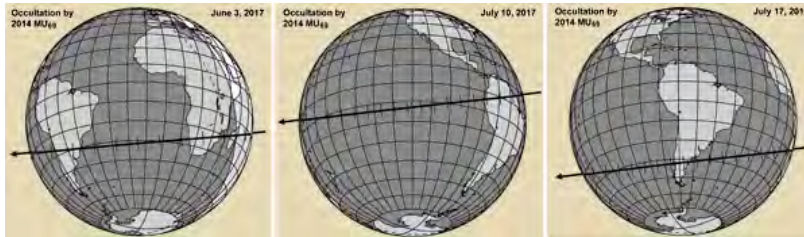

http://www.boulder.swri.edu/MU69_occ/july17.html

<https://www.nasa.gov/feature/new-horizons-deploys-global-team-for-rare-look-at-next-flyby-target>

<https://www.nasa.gov/feature/nasa-s-new-horizons-team-strikes-gold-in-argentina>

QHY-174M-GPS			
Sensor	Sony IMX174 Exmor CMOS	Total Pixels	2.3 Megapixels
Pixel Size	5.86um	A/D Resolution	12-bit
Pixel Array	1920 x 1200	Read Noise	3e- to 5e-
Optical Format	1/1.2-inch	Full Well Capacity	32ke-
Shutter	Electronic (Global)	Cooling Delta	-40C Regulated
Exposure Time	50us - 1800sec	Computer Interface	USB 3.0
FPS @ Full Resolution	138FPS	Weight (Mono/Color)	450g
FPS @ ROI	490@480x300	Reference Price (Cooled / Uncooled)	\$1239 / \$939

Please note prices are subject to change without notice, please check with QHYCCD or your dealer for current prices



QHYCCD

QHY Cooled Medium Size CMOS Cameras QHY183/163/165 168/247/128/367

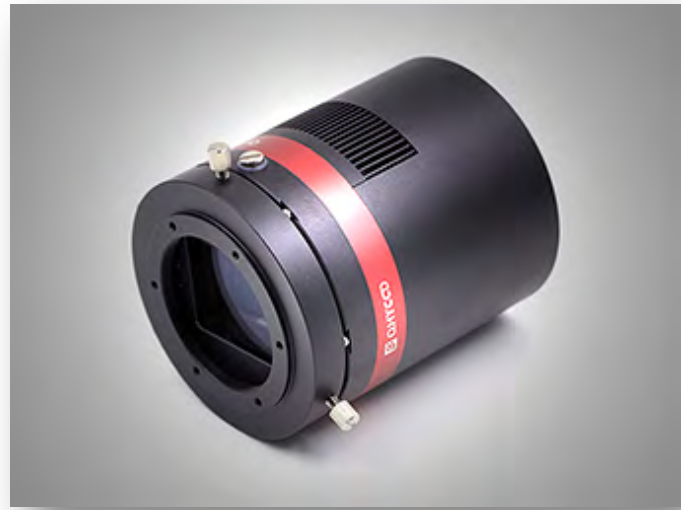

The QHYCCD medium size COLDMOS camera series includes all of our cooled cameras with CMOS sensor sizes from 1 inch to Full Frame (35mm Format) and includes back-illuminated as well as front-illuminated CMOS sensors in both mono and color. Medium COLDMOS cameras can internally record and store up to 1000 frames of a star image ROI for exoplanet investigation, occultations, atmospheric seeing measurements, focus analysis, optics analysis, etc.

- Front-illuminated and Back-illuminated Sensors
- Lightweight Compact Design
- Regulated TE Cooling Delta -35C to -40C
- 128 MB DDR Frame Buffer
- ST-4 Compatible Guide Port
- Filter Wheel Port
- Anti-Noise Technology
- Anti-Amp Glow Technology
- Anti-Dew Technology
- USB 3.0

All models include a heated optical window to prevent external dew, a desiccant plug socket to help maintain a frost-free CMOS chamber, a 128MB frame buffer, a filter wheel port, and 2-stage TE cooling to reduce the sensor temperature to -35C or -40C below ambient along with temperature regulation to maintain a constant temperature set point. Due to the efficient TE cooling, single exposures many minutes in duration are possible, making them ideally suited for deep space imaging of dim objects as well as brighter objects and planets. The Horsehead Nebula image on the reverse side is only 3 x 20 minute single-shot color exposures.

Six of these medium sized COLDMOS cameras use Sony Exmor CMOS sensors, including the two largest with 24 and 36 Megapixels, respectively, in 35mm format sensors. Even these large sensors deliver multiple frames per second at full resolution. These front illuminated sensors also exhibit very high sensitivity. One model in this group (QHY163M/C) uses a 4/3-inch Panasonic sensor and one model (QHY183M/C) uses a Sony STARVIS Exmore R back-illuminated sensor. STARVIS is Sony's designation for sensors capable of recording under starlight. These back-illuminated sensors have even greater sensitivity as well as noise reduction - the key factors to enhancing image quality, while radically realigning their fundamental pixel structure from front-illumination to back-illumination. They retain the advantages of CMOS image sensors such as low power consumption and high-speed operation while dramatically improving sensitivity.



Horsehead Nebula Image QHY-128C, Courtesy Tony Hallas

Model	QHY-183M/C	QHY-163M/C	QHY-165C	QHY-168C	QHY-247C	QHY-128C	QHY-367C
Sensor	Sony IMX183 Exmor R CMOS	Panasonic MN34230 CMOS	Sony IMX080 Exmor CMOS	Sony IMX071 Exmor CMOS	Sony IMX193 Exmor CMOS	Sony IMX128 Exmor CMOS	Sony IMX094 Exmor CMOS
Illumination	Back Illuminated	Front Illuminated	Front Illuminated	Front Illuminated	Front Illuminated	Front Illuminated	Front Illuminated
Total Pixels	20 Megapixels	16 Megapixels	16 Megapixels	16 Megapixels	24 Megapixels	24 Megapixels	36.4 Megapixels
Pixel Size	2.4um	3.8um	4.8um	4.8um	3.91um	5.97um	4.88um
Pixel Array	5544 x 3694	4656 x 3522	4952 x 3288	4952 x 3288	6024 x 4024	6036 x 4028	7376 x 4938
Optical Format	1-inch	4/3-inch	APS-C	APS-C	APS-C	Full Frame 35mm	Full Frame 35mm
FPS @ ROI	25@12Mp	100@800x600	130FPS@240 line	130FPS@240 line	10@1920x1080	32@480 lines	83@100 lines
FPS @ Full Resolution	15FPS	22.5FPS	10FPS	10FPS	3FPS	5FPS	3.2FPS
Shutter	Electronic	Electronic	Electronic	Electronic	Electronic	Electronic	Electronic
A/D Resolution	12-bit	12-bit	12-bit	14-bit	14-bit	14-bit	14-bit
Read Noise	1e- to 2.7e-	1e- to 2.4e-	2.3e- to 3.2e-	2.3e- to 3.2e-	1e- to 2.7e-	1.8e- to 4e-	2.4e- to 3.2e-
Full Well	16ke-	20ke-	46ke-	46ke-	36ke-	74ke-	56ke-
Weight (M/C)	450g	450g	700g	700g	699g	788g	788g
Reference Price (M/C)	\$1099 / \$949	\$1269 / \$999	\$1199	\$1499	\$1999	\$3499	\$4399
Exposure	50us - 3600sec	50us - 1800sec	30us - 3600sec	30us - 3600sec	50us - 3600sec	60us - 3600se	60us - 3600se
Cooling Delta	-40C, Regulated	-40C, Regulated	-35C, Regulated	-35C, Regulated	-35C, Regulated	-35C, Regulated	-35C, Regulated

Please note prices are subject to change without notice, please check with QHYCCD or your dealer for current prices



QHYCCD

QHY183M/C

20MP Back-Illuminated Monochrome or Color Cooled CMOS



The **QHY183M** is a one-inch, 20 Megapixel back-illuminated monochrome CMOS camera with a peak QE of 84%. The pixel size is 2.4um, yielding high-resolution with modest size telescopes. The camera is capable of producing 15FPS@20 Megapixels. It has a two-stage TEC that cools the sensor to -40C to -45C below ambient. The ADC is 12-bit / 16-bit with 1e- read noise! The computer interface is USB 3.0 and exposure times can be set from 50us to 3600sec.

Sony's Image Sensor **Exmor R** is a back-illuminated CMOS image sensor with improved sensitivity and noise reduction - the key factors to enhancing image quality, while radically realigning their fundamental pixel structure from front-illumination to back-illumination. It retains the advantages of CMOS image high-speed operation while dramatically improving sensitivity.

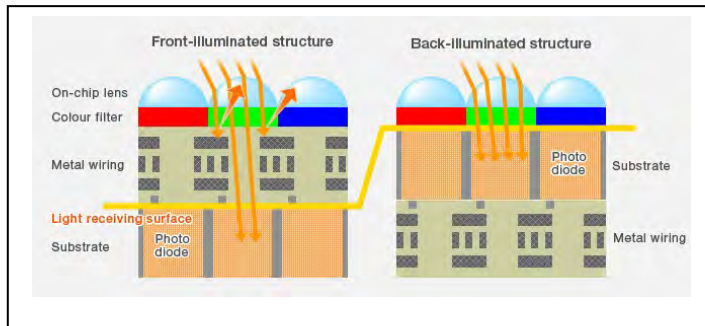

The QHY183M has a **128MB DDR Memory Buffer**. A QHY183M 16-bit image is about 40MB, so 128MB of memory can easily buffer a full frame for transfer to the computer using QHY183M software with native single-frame shooting function. This makes data transfer to the computer stable and reliable because there is no USB bandwidth or busy CPU problems. The QHY183 can internally record and store up to 1000 frames of a star image ROI (Region of Interest) for analysis of exoplanet investigation, occultations, atmospheric seeing measurements, focus analysis, optics analysis, etc.

The QHY183M utilizes the **Anti-Dew** features common to the QHY COLDMOS cameras. A heated optical window prevents exterior dew from forming, and the CMOS chamber has a desiccant plug socket to prevent moisture from forming on the sensor at cold temperatures.

The QHY183M incorporates QHY's **Anti-Amp Glow** technology to significantly reduce typical CMOS amplifier glow to a minimum, allowing excellent calibration by subtracting a dark frame.

The QHY183M includes a **Filter Wheel Package**. Get a QHYCFW3, 7-Position Filter Wheel at half-price with the purchase of a QHY183M camera!

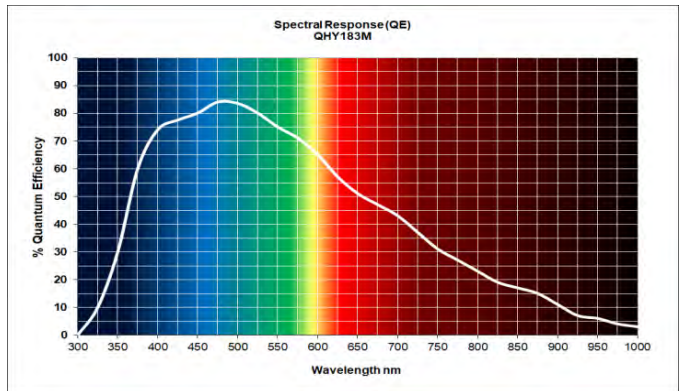
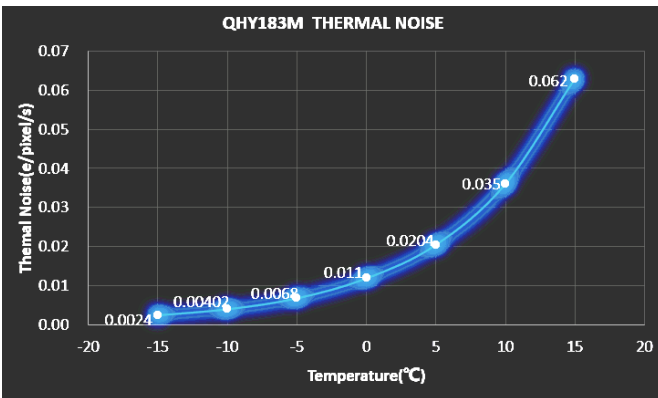
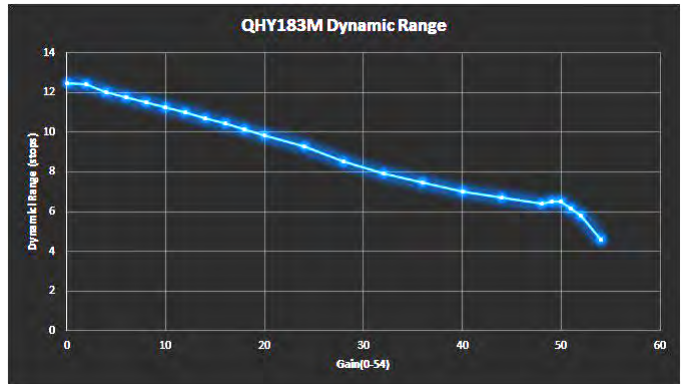
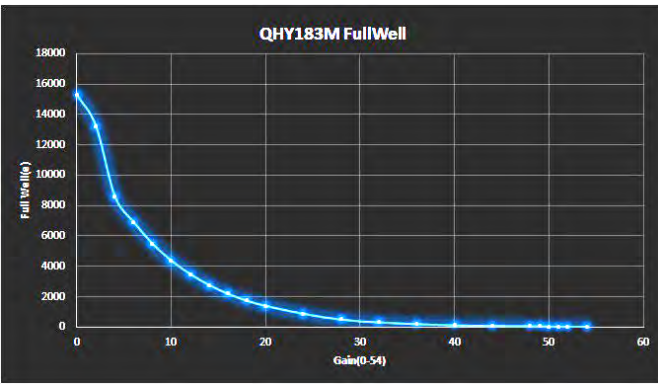
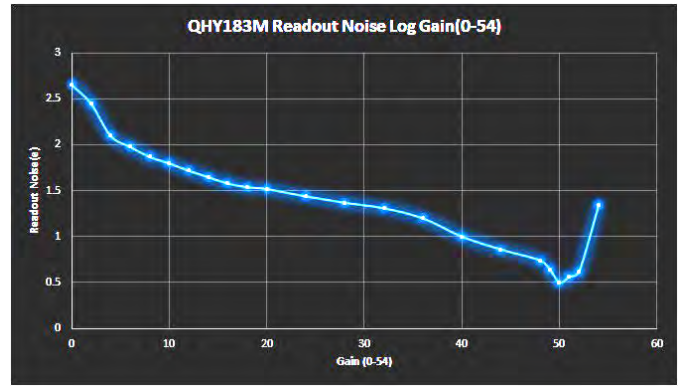
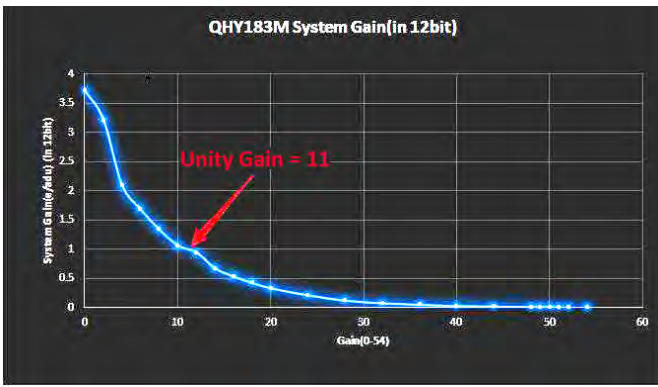

QHY183M			
Sensor	Sony IMX183 Back-Illuminated CMOS	Peak QE	84%
Optical Format	Typical 1-inch	Read Noise	1.0e@high gain, 2.7e-@Low gain
Sensor Size	13.3mm x 8.9mm	Dark Current	0.0024e-/p/s@-15C
Pixel Size	2.4um x 2.4um	Frame Rate	15FPS@20Mp, 25FPS@4K HD, 5FPS@12Mp
Effective Pixels	5544 x 3694, 20 Megapixels	Full Well	15ke- to 16ke-
Binning	1 x 1	Cooling Delta T	2-stage TEC, -40C Regulated
Readout Type	Progressive Scan	Computer	USB3.0
Shutter	Electronic Shutter	Mechanical	M54/0.75 female thread
Exposure Time	50us-3600 sec	Weight	699g
Frame Rate	15FPS@20Mp, 25FPS@4K HD, 5FPS@12Mp	Power	30W @ 100% TEC, 13W @ 50%TEC
Reference Price	\$1099. Plus 50% off the price of a QHYCFW3S Filter Wheel or 50% off the price of a QHY183C Color Camera with the purchase of a QHY183M. Limited offer - Check with QHYCCD for availability		

Please note prices are subject to change without notice, please check with QHYCCD or your dealer for current prices



QHYCCD

QHY-128C/QHY367Pro-C Full Frame, 35mm Format Color Cameras

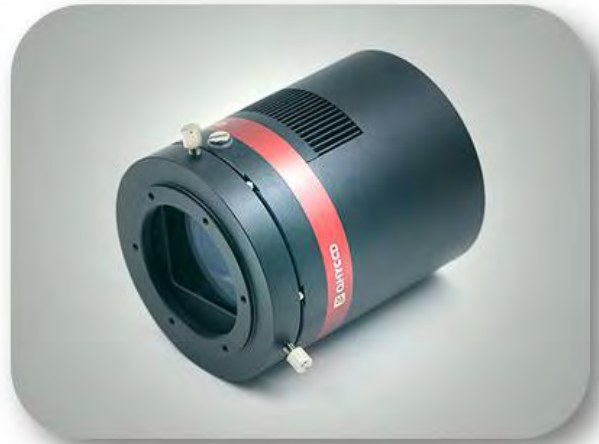

The QHY128C uses a 24 Megapixel sensor with 5.96u pixels and the QHY367C uses a 36 Megapixel sensor with 4.88u pixels. Both models can internally record and store up to 1000 frames of a star image ROI (Region of Interest) for analysis of exoplanet investigation, occultations, atmospheric seeing measurements, focus analysis, optics analysis, etc.

- USB 3.0, 5 FPS up to 30 FPS for partial frames
- Ultra High Performance
- Ultra Low Read Noise and Dark Current
- High Dynamic Range
- Zero Amplifier Glow
- Unique Thermal Noise Reduction Technology
- 128MB DDRII Image Buffer
- True RAW Image Output
- Anti-Dew Technology
- AR+AR Coated Optical Window
- Anti-reflection Black Case for F2 Imaging Systems
- High Precision Axis Calibration (no need for tilt corrections)

The Sony Exmore IMX128 sensor has been used in a number of commercial products including the Nikon D600, 610 and 750 cameras, and the Sony DSC-RX1 camera. The IMX367 was designed to produce ultra high resolution 4K video as well as 36MP still images. In the QHY cameras, these sensors are implemented specifically for astronomical use with custom thermal noise reduction technology that does not affect the accuracy of the raw image. Amplifier glow can also be an issue with some CMOS cameras, but these new QHY models boast the rare capability of zero amplifier glow, no matter how long the exposure. The image output is a true raw image, without any internal processing for maximum flexibility with image processing software. Other features include a 128MB image buffer that helps tremendously with slower computers using USB 2.0, and when running multiple cameras using the same computer. The optical window has built-in dew control and the chamber is protected from internal humidity condensation. The optical window is AR+AR coated, reducing halos around bright stars. IR blocking is not used so that the cameras can be used with maximum sensitivity to H-alpha and near IR light when desired, or a simple IR blocking filter can be attached for typical RGB imaging with IR cut. Each camera is carefully calibrated to high precision assuring flatness of the sensor to +/- 20 microns from edge to edge, eliminating the need for external adjustments by the user.

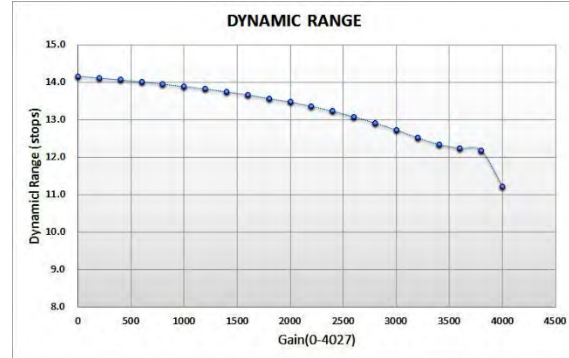
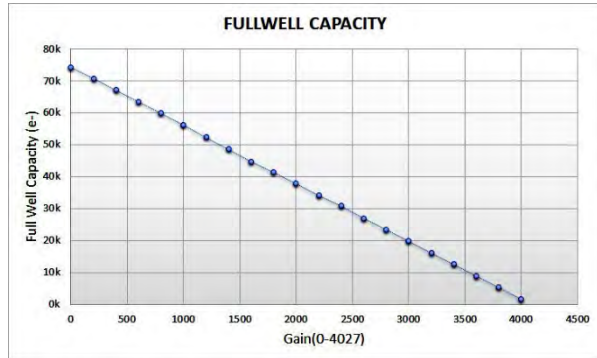
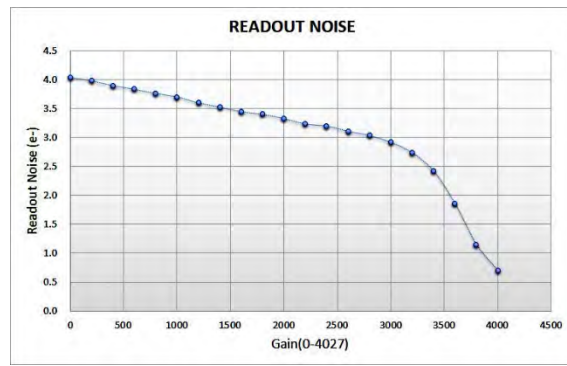
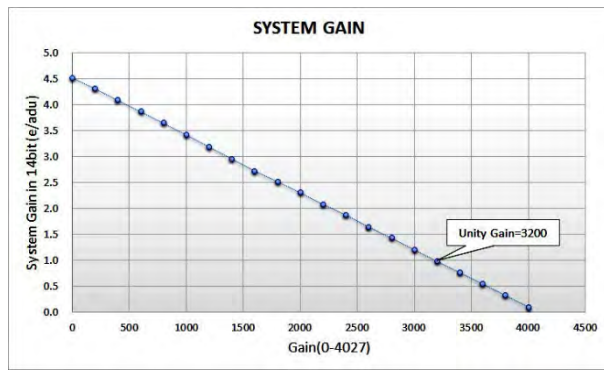

Graphs represent typical performance of QHY128C camera

Model	QHY128C	QHY367C
Sensor	Sony IMX128 Color CMOS	Sony IMX094 Color CMOS
Sensor Size	36mm x 24mm full frame	36mm x 24mm full frame
Pixel Size	5.97um x 5.97um	4.88um x 4.88um
Effective Pixels	6036 x 4028 24 Megapixels	7376 x 4938 36.4 Megapixels
Binning	1 x 1	1 x 1
Full Well	74ke-	56ke-
Readout Type	Progressive Scan	Progressive Scan
Shutter	Electronic shutter	Electronic shutter
Exposure Time	60us - 3600 sec	60us - 3600 sec
Peak QE	53%	TBD
AD Convert	14-bit	14-bit
Readout Noise	4e-@Low gain, 2.7e-@unity gain	3.2e-@Low gain, 2.4e-@unity gain
Maximum Dynamic Range	More than 1:17000 >14 STOPS	More than 1:17000 >14 STOPS
Mechanical Interface	M54/0.75 female thread	M54/0.75 female thread
Computer Interface	USB3.0, 12V DC Power socket	USB3.0, 12V DC Power socket
Cooling Delta T	2-stage TEC -35C below ambient	2-stage TEC -35C below ambient
Power Consumption	30W @ 100% TEC, 13W @ 50%TEC	30W @ 100% TEC, 13W @ 50%TEC
Price / Weight	\$3499 / 788g.	\$4399 / 788g.
Frame Rate	5FPS@Full Resolution 9FPS@2160 LINES (e.g. 7400*2160, 4096*2160) 16.5FPS@1080 LINES (e.g. 7400*1080, 1920*1080) 22.5FPS@768 LINES 32FPS@480 LINES	3.2FPS@Full Frame 7FPS@2160 LINES (e.g. 7400*2160, 4096*2160) 14FPS@1080 LINES (e.g. 7400*1080, 1920*1080) 19FPS@768 LINES, 30FPS@480 LINES 40FPS@320 LINES, 83FPS@100 LINES

Please note prices are subject to change without notice, please check with QHYCCD or your dealer for current prices



QHY294C

11.6 Megapixel 4/3-inch, Back-Illuminated Color CMOS Camera



Back-Illuminated / High QE Sensor

The QHY294C camera uses a Sony IMX294, 4/3-inch, back-illuminated, cooled, color CMOS sensor with 11.6 Megapixels, 14-bit A/D and 1e- read noise at highest gain. The QHY294C full well capacity is nearly 65,000 electrons with 4.63um x 4.63um pixels, almost the same as an interline CCD camera with 9um pixels. Sony estimates that the back-illuminated design is about 2X as sensitive as a comparable front-illuminated sensor. We estimate the peak QE, including filters, is approximately 75%.

High Resolution Frame Rates

The QHY294C produces 16.5 frames per second at high resolution with 14-bit A/D. Higher rates are achieved for regions of interest, for example, 41 FPS at 1080 lines (up to 290 FPS for small regions).

Low Dark Current 0.005e-/p/s @ -20C

The QHY294C uses QHYCCD's proprietary low dark current control technology. This technology significantly reduces the dark current noise in our CMOS cameras. The QHY294C has very low dark current as a result, lower than many CCD cameras, allowing for very long exposure times.

Dual Gain Auto Switch - HGC/LGC MODE Boosts Low Light Performance

The QHY294C's CMOS sensor has a dual gain mode, HGC (high gain) and LGC (Low gain). The QHY294C will switch the two modes automatically when the gain is set to 1600 you will get the benefits of the ultra-low read noise (1e- to 1.6e-) of the HGC mode and a full well capacity of about 14.5ke- at the switch point setting.

Anti-Dew Technology

The QHY294C benefits from more than a decade of cooled camera design experience. QHYCCD has implemented full dew control solutions. The optical window has a built-in dew heater and the CMOS chamber is protected from internal humidity condensation.

Flexible Adapters

The QHY294C has the same body design and mechanical interface and the QHY163. It has a short back focal distance allowing the use of QHYCCD's 0.5mm-27mm spacers (step size 0.5mm) for flexibility in setting up your optical train.

256MB DDR3 Image Buffer

The QHY294C has an internal 256MByte high speed DDR3 image buffer. This is more than enough for one frame and it significantly reduces any issue of lost frames due to a busy computer CPU or slow USB communication packet errors.

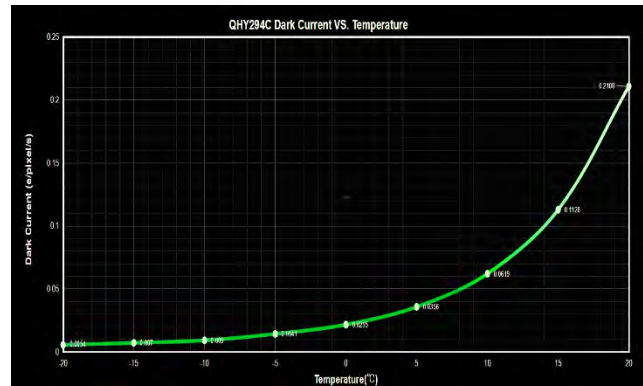
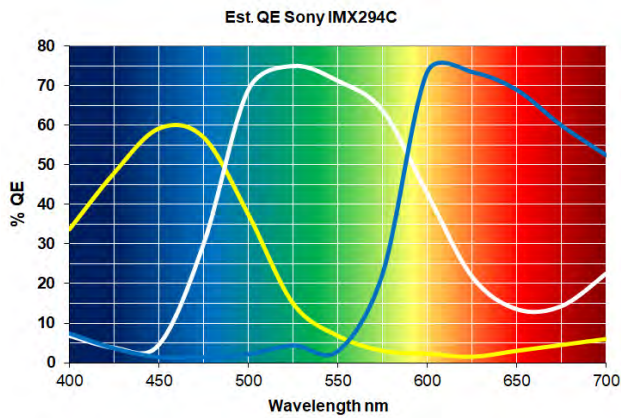

		QHY294C	
Sensor	Sony IMX294 Back-Illuminated CMOS	Peak QE	75%
Optical Format	Typical 4/3-inch	Read Noise	1.0e-to 1.6e-HGC, 4.2e-to 6.8e-LGC
Sensor Size	19.28 mm x 12.95 mm	Dark Current	0.005e-/p/s@-20C
Pixel Size	4.63 um	Full Well	65ke-
Effective Pixels	4164 x 2796, 11.6 Megapixels	Cooling / Delta T	2-stage TEC, --30 to -35C Regulated
A/D	14-bit (output as 16-bits and 8-bits)	Mechanical	M42/0.75 female thread
Shutter	Electronic Shutter	Weight	650g
Exposure Time	60us-3600 sec	Frame Rate FF/ROI	16.5FPS FF to 290 FPS ROI
Computer	USB3.0	Reference Price	999 USD (not including tax)
Non-volatile memory In-camera storage	100 Kbytes user-accessible space for stellar ROI frames for analysis of exoplanet investigation, occultations, atmospheric seeing measurement, focus, optical analysis etc. 100*100 image x 10frames, 50*50 image x 40 frames, 25*25 image x160 frames,10*10 image x 1000 frames.		



QHY268C

Back-Illuminated APS-C Format Color Camera



Ultra High Resolution, 26 Megapixels, APS-C format

QHY268C is a 26 Megapixel back-illuminated cooled color CMOS camera with 16-bit A/D and 3.76um pixels. The QHY268C is available only in a color model.

Native 16-bit A/D, 65536 Levels

The QHY268C is the CMOS camera with native 16-bit A/D on-chip. The output is real 16-bits with 65536 levels. To compare with the 12bit and 14bit ADC. The 16bit ADC can get high sample resolution, system gain will be less than 1e/ADU. No sample error noise and low noise.

Full Well, 44ke- at 3.76um, 396ke- at 11um

One benefit of the back-illuminated CMOS structure is improved full well capacity. This is particularly helpful for sensors with small pixels. Even with unbinned 3.76um pixels the QHY268C has a full well capacity of 44ke-. When binned 2x2 to 7.5um the full well is 176ke- and when binned 3x3 to 11um the full well is 396ke-.

Ultra-Low Read Noise, 1 Electron at High Gain

The QHY268 has only one electron of read noise at high gain and 15FPS high readout speed. One electron of read noise means the camera can achieve a SNR>3 at only 3 to 4 photons. This is perfect performance when conditions are photon limited, i.e., short exposures, narrow band imaging, etc., making this large area sensor ideal for sky surveys and time domain astronomy.

Low Dark Current, TE Cooling, Round Body

The QHY268C has extremely low dark current using SONY's Exmor BSI CMOS technology. In addition, the camera uses QHYCCD's proprietary thermal noise reduction technology and 2-stage TE cooling to reduce the dark current noise to extremely low levels. The round body and sensor size make this camera ideal for Hyperstar systems. The camera has a USB3.0 interface to the computer.



PRELIMINARY SPECIFICATIONS

Model	QHY268U3GC
Image Sensor	SONY IMX571 APS-C BSI CMOS Sensor
Array	6252 x 4176 (26 Megapixels)
Pixel Size	3.76um x 3.76um
Image Area	APS-C Format, 23.5mm x 15.7mm (28.3mm Diagonal)
Color / Mono	Color Only
Full Well Capacity (1x1, 2x2, 3x3)	44ke- / 176ke- / 396ke-
A/D	16-bit binned 1X1, 18-bit in 2X2, 19-bit in 3X3, 20-bit in 4 x 4
Full Frame Rate	10FPS (USB3.0)
Read Noise	1.0e- (at high gain)
Dark Current	TBD
Exposure Time Range	20us - 3600sec
Firmware/FPGA remotely upgrade	Yes, via USB port
Shutter Type	Electronic Rolling Shutter
Computer Interface	USB3.0 / GigaE
Built-in Image Buffer	2GByte (16Gbit)
Cooling System	Dual Stage TE Cooler -35C below ambient
Anti-Dew Heater	Yes
Telescope Interface	M54/0.75
Optical Window	AR+AR High Quality Multi-Layer Anti-Reflection Coating



QHYCCD

QHY9 Monochrome KAF-8300 CCD Camera 8.3 Megapixels

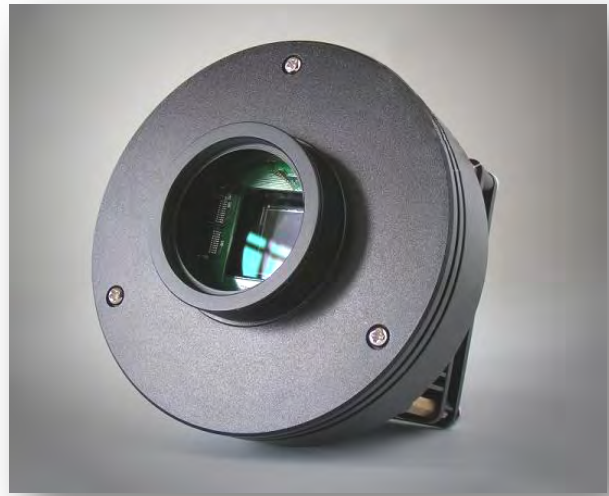

The QHY9 is a classic mono camera using the very popular On Semiconductor (Kodak) 8.3 Megapixel KAF-8300 CCD sensor. This sensor has a relatively large field of view for its price, and good QE for deep sky imaging. The peak QE is 56%, and it has 48% QE at the wavelength of H-alpha. The QHY9 has two-stage thermoelectric cooling with a typical delta T of -45C below ambient. This offers outstanding thermal noise control. Compared to competing models, the QHY9 offers 20 to 25 additional degrees of cooling. Since the dark current is reduced by half for approximately every 6 to 7 degrees of cooling, this means that there is approximately 10X less dark current in the QHY9 compared to these other models. The QHY9 give you excellent dark current noise reduction even in long exposures taken on a hot summer night. The model QHY9 is also a round design, more appropriately suited for use in Hyperstar telescopes.

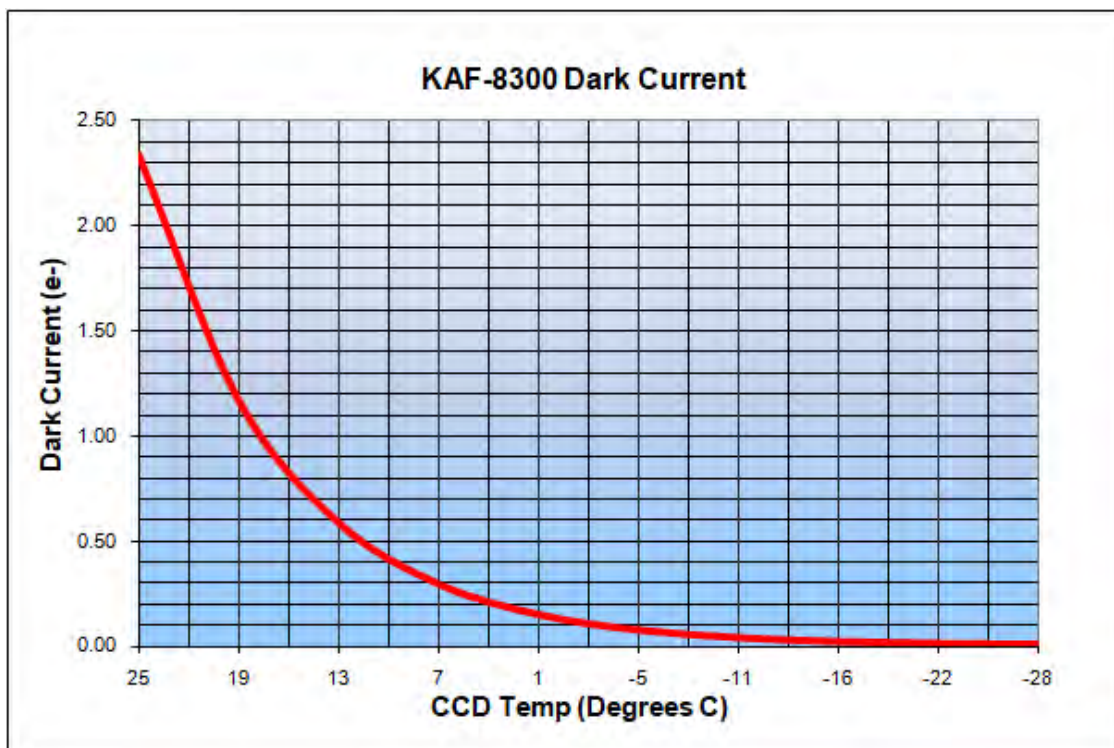

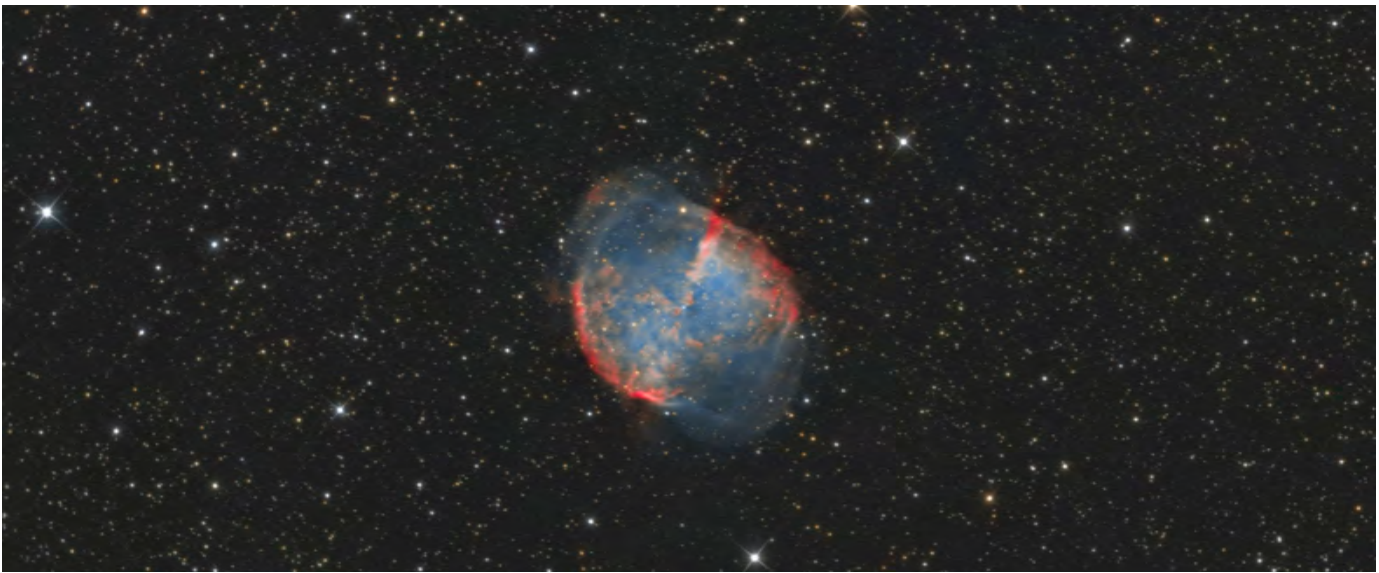

Dumbell Image taken with QHY9 from London, courtesy Jaspal Chadha

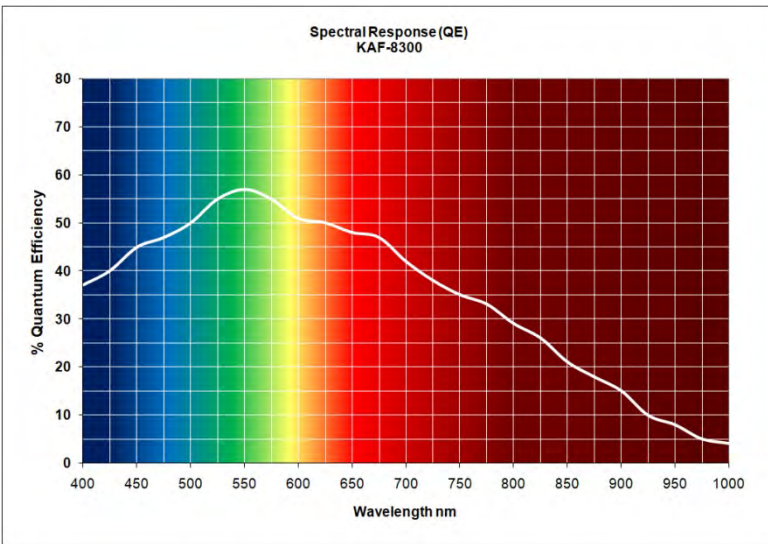

Model	QHY9
Sensor	KAF-8300 (Mono) Full Frame CCD
Optical Format	4/3-inch
Sensor Size	17.96mm x 13.52mm (22.5mm diagonal)
Total Active Pixels	8.3 Megapixels
Pixel Size	5.4um x 5.4um
Active Pixel Array	3358 x 2536
Cooling Delta T	-45C Typical, Regulated, -50C Max
Read Noise	9e- typical
Shutter	Mechanical
A/D Resolution	16-bit
Peak QE	56%
Full Well Capacity	25.5ke-
Computer Interface	USB 2.0
Weight	510g
Reference Price	\$1999 includes QHYCFW2-S filter Wheel for 36mm unmounted filters

Please note prices are subject to change without notice, please check with QHYCCD or your dealer for current prices



QHYCCD

QHY10/12 APS-C Sony Single-Shot Color CCD Cameras



The **QHY10** is an APS-C size cooled single shot CCD camera using SONY's ICX493AQA sensor. It has 10 Megapixels with a pixel size of 6.05 x 6.05um. The QHY10 has two-stage thermoelectric cooling that reduces the temperature of the CCD to -40C below ambient. The combination of QHYCCD cooling technology and SONY SuperHAD low dark current technology results in an exceptionally clean, low noise image, even in a very long exposure. In addition to the very low thermal noise of Sony's SuperHAD technology, this sensor has a high full well capacity. Even with high resolution 6.05um square pixels, it has a 45ke- full well. This is almost double that of the ICX413 with 7.8um square pixels, and almost double that of the KAF-8300 color sensor with 5.4um square pixels. The high full well capacity yields a higher dynamic range allowing a longer exposure time without signal saturation. This yields better colors and smaller star points. The QHY10 comes with a clip for USB and power cables to help keep solid connections and avoid conditions that result in loss of contact. Compared to cameras using the KAF-8300C, the QHY10 has a larger sensor, larger pixel size, more pixels, greater full well capacity (dynamic range), lower thermal noise, lower read noise, and smaller body size. It has an electronic shutter and 2-stage TE cooling.



The **QHY12** has all of the features of the QHY10 but with 14.2 Megapixels it has the highest resolution in the QHYCCD cooled APS size color CCD family. The QHY12 uses a Sony ICX613 Super HAD sensor with very low thermal noise and readout noise. If you have a Hyperstar telescope or short fast refractor, the QHY12 is an excellent choice. Its small diameter will not obstruct the entrance beyond the secondary of a hyperstar and the small 5.12um pixels will yield high resolution of deep space objects.



Model	QHY10	QHY12
Sony Sensor	ICX493 CCD	ICX613 Super HAD CCD
Illumination	Front Illuminated	Front Illuminated
Total Pixels	10.2 Megapixels	14.2 Megapixels
Pixel Size	6.05um x 6.05um	5.12um x 5.12um
Pixel Array	3900 x 2626	4610 x 3080
Optical Format	APS-C	APS-C
Cooling Delta T	-40C	-40C
Shutter	Electronic	Electronic
A/D Resolution	16-bit	16-bit
Read Noise	8e- to 10e-	8e- to 10e-
ABG	-100dB	-100dB
Weight (M/C)	400g	400g
Reference Price (M/C)	\$1699	\$2699



QHYCCD

QHY22 and QHY23 Sony Monochrome CCD Cameras



The QHY22 and QHY23 cameras use Sony's high-sensitivity EXview HAD CCD II sensors, ICX694 and ICX814, respectively. These sensors have very high QE (close to 80%) and very low thermal noise. QHYCCD's dual stage TE cooling technology reduce the sensor temperature up to -45C below ambient for exceptionally low dark current. Compared to competing models, the QHY cameras achieve -10C to -15C extra cooling, resulting in very low noise and uniform background even during the hot summer months.

The read noise of these cameras is also a highlight of their performance. Typical read noise is around 5 electrons. Low read noise is very important when you want to capture faint deep sky objects or when using narrowband filters. Less read noise also means you can get a better image when you stack multiple frames. These Sony sensors all have relatively small pixels for high resolution. Using a suitable OTA results in outstanding detail, as the sample images on the reverse of this page demonstrate.

The QHY22 and QHY23 offer full moisture control, including an air-proof CCD chamber with desiccant plug socket and a CCD chamber optical window heater. Mechanically, the QHY22 and QHY23 are solidly built and include USB/Power cable support. With this support, the USB and power cable will stay solidly affixed to the camera assuring a constant electrical contact.



Both models have a built-in USB 2.0 HUB and dual USB to RS232 converter. External trigger in and out is provided at the back of the camera. A guiding camera, mount and electric focuser can all connect directly to the camera instead of separate connections to the computer. Only one USB cable is required control the whole system for capturing an image. The power socket has a threaded locking collar and the 3-pin aviation socket RS232 port make the system stable and solid. A 4-pin color wheel port is also available to connect a QHY color filter wheel.

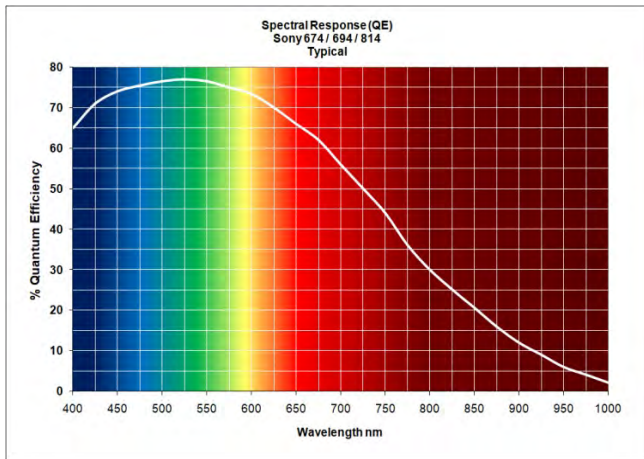
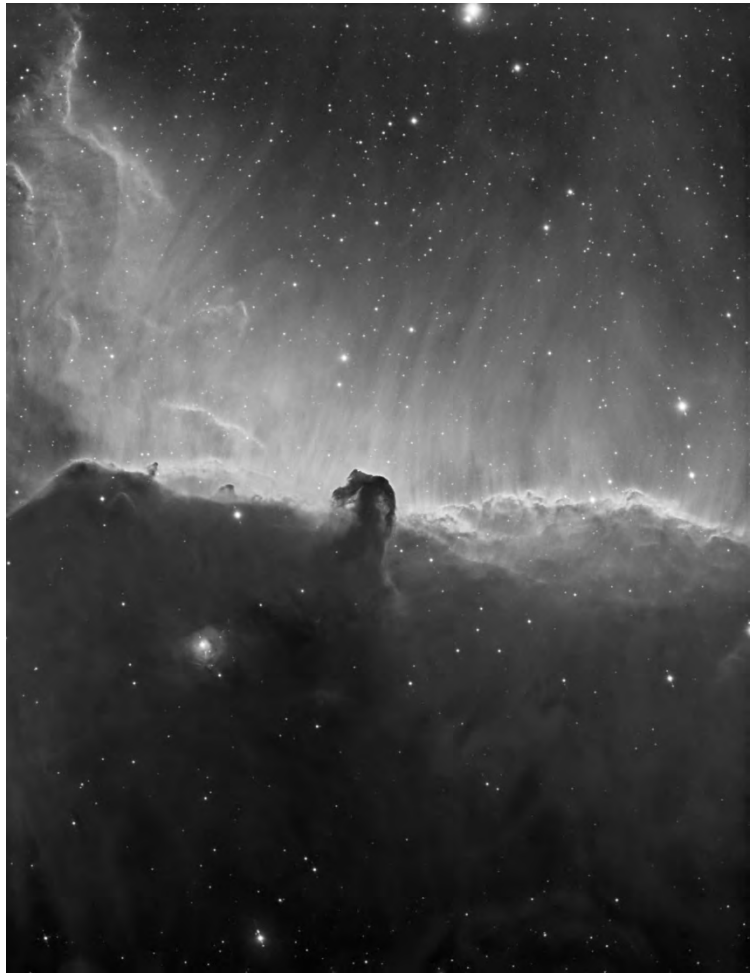

Rosette and Horsehead Nebula images by Jaime Alemany using QHY22 camera. Horsehead: 7 hours, No darks, no flats, no bias.

Model	QHY22	QHY23
Sensor	Sony ICX694	Sony ICX814
Optical Format	1 inch	1 inch
Sensor Size	12.5mm x 10mm	12.5mm x 10mm
Total Pixels	6.1 Megapixels	9.2 Megapixels
Pixel Size	4.54um	3.69um
Pixel Array	2758 x 2208	3388 x 2712
Cooling Delta T	-45C	-45C
Read Noise	5e- Typical	5e- Typical
Shutter	Electronic	Electronic
A/D Resolution	16-bit	16-bit
Peak QE	79%	79%
Full Well Capacity	15ke- to 20ke-	15ke- to 20ke-
Computer Interface	USB 2.0	USB 2.0
Weight	516g	516g
Reference Price	\$2595	\$2995



QHYCCD

QHY27/28/29 APS-H and Full Frame Cooled CCD Cameras



The QHY27, QHY28 and QHY29 cameras use the latest Truesense interline CCD sensors. These sensors have electronic shutters for very short exposure times. The QHY27 with KAI-16050 CCD is APS-H format. The QHY28 with KAI-16070 CCD and QHY29 with KAI-29050 CCD are full frame (35mm format) CCDs. QHYCCD's anti-dew technology and 2-stage TE cooling enable cooling of the sensor to -45C below ambient. This reduces the dark current to less than 0.05e- at typical operating temperatures.

The KAI-16050 Image Sensor is a 16-megapixel CCD in an APS-H optical format. Based on the TRUESENSE 5.5 micron Interline Transfer CCD Platform, the sensor features broad dynamic range, excellent imaging performance, and a flexible readout architecture. A vertical overflow drain structure suppresses image blooming and enables electronic shuttering for precise exposure control.

The KAI-16070 Image Sensor is a 16-megapixel CCD in a 35 mm optical format. Based on the TRUESENSE 7.4 micron Interline Transfer CCD Platform, the sensor provides very high smear rejection and up to 82 dB linear dynamic range through the use of a unique dual-gain amplifier. A vertical overflow drain structure suppresses image blooming and enables electronic shuttering for precise exposure control.

The KAI-29050 Image Sensor is a 29 Megapixel CCD in a 35 mm optical format. Based on the TRUESENSE 5.5 micron Interline Transfer CCD Platform, the sensor features broad dynamic range, excellent imaging performance, and a flexible readout architecture. A vertical overflow drain structure suppresses image blooming and enables electronic shuttering for precise exposure control.

All three models have a built-in USB 2.0 HUB and dual USB to RS232 converter. External trigger in and out is provided at the back of the camera. A guiding camera, mount and electric focuser can all connect directly to the camera instead of separate connections to the computer. Only one USB cable is required control the whole system for capturing an image. The power socket has a threaded locking collar and the 3-pin aviation socket RS232 port make the system stable and solid. A 4-pin color wheel port is also available to connect a QHY color filter wheel.

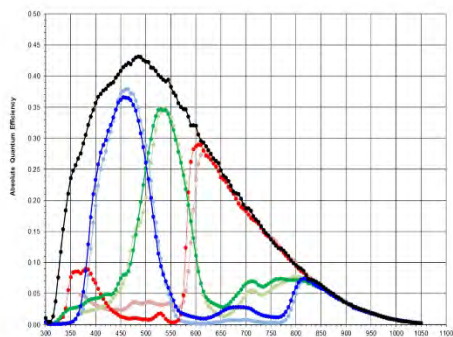
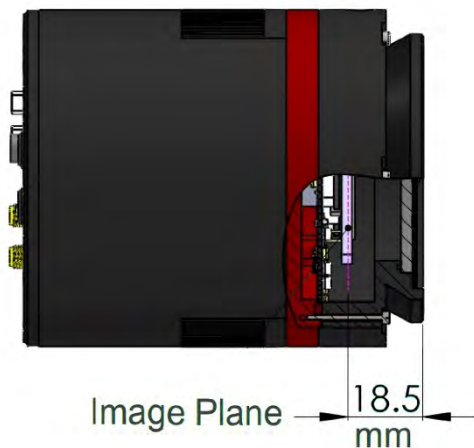
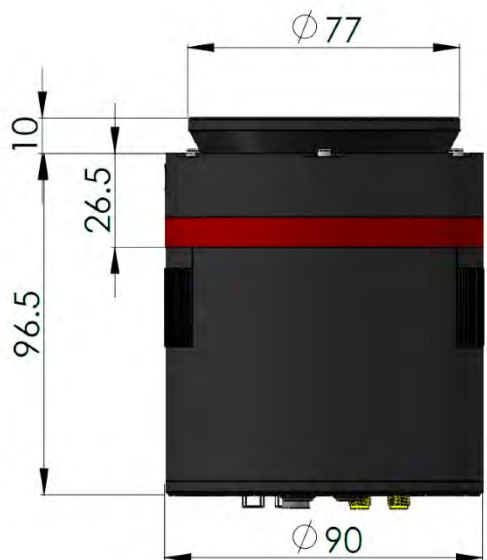

QE KAI-16050 Mono / Color

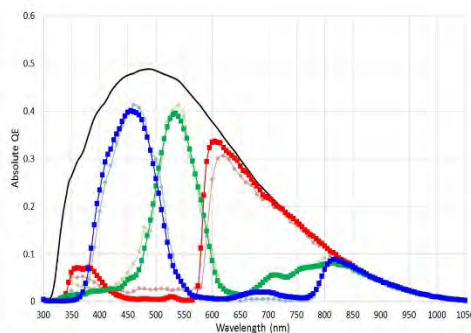

QE KAI-16070 Mono / Color

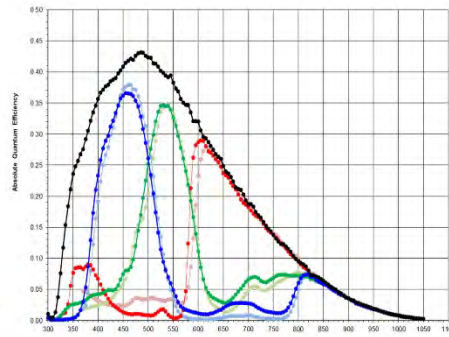

QE KAI-29050 Mono / Color

Model	QHY27	QHY28	QHY29
Sensor	On Semiconductor (Kodak) Truesense KAI-16050 CCD	On Semiconductor (Kodak) Truesense KAI-16070 CCD	On Semiconductor (Kodak) Truesense KAI-29050 CCD
Optical Format	APS-H	Full Frame (35mm Format)	Full Frame (35mm Format)
Sensor Size	26.93 x 17.95mm	36.0 x 23.9mm	36.17 x 24.11mm
Total Pixels	16 Megapixels	16 Megapixels	29 Megapixels
Pixel Size	5.5um	7.4um	5.5um
Pixel Array	4964 x 3332	4932 x 3300	6644 x 4452
Cooling Delta T	-45C	-45C	-45C
Read Noise	9e-	9e-	9e-
Shutter	Electronic	Electronic	Electronic
A/D Resolution	16-bit	16-bit	16-bit
Dark Current @ -15C	<0.05e-/p/s	<0.05e-/p/s	<0.05e-/p/s
Full Well Capacity	20ke-	44ke-	20ke-
Computer Interface	USB 2.0	USB 2.0	USB 2.0
Weight	709g	709g	709g
Reference Price	\$4500	\$6500	\$7500

Please note prices are subject to change without notice, please check with QHYCCD or your dealer for current prices



QHYCCD

QHY695A 6 Megapixel High QE, Low Noise 1" Cooled CCD Camera



Sony ICX695 ExView II CCD

The QHY695A uses the Sony ICX695 ExView II CCD, a 1-inch, 6 megapixel sensor with a peak QE close to 80%. The read noise is as low as 4 electrons. With the two-stage TEC reducing the sensor temperature to -40C below ambient, and the extremely low thermal noise of this CCD, this camera produces an exceptionally clean image.

"A" Series Camera –Fully Integrated with Filter Wheel

The QHY695A belongs to the new QHYCCD "A" series camera family. "A" stands for "ALL-IN-ONE". It includes a built-in motor driven filter wheel and it natively supports the medium size QHYOAG. The OAG can be installed on the camera solidly with six screws consuming a minimum of back focus, precious for some optical systems. The filter wheel in QHY695A has 7-positions for 36mm unmounted filters, or an alternative carousel with 8-positions for 1.25" mounted filters.

Internal USB Hub

In addition to the filter wheel and OAG, the "A" series camera also offers an internal USB HUB(2.0) providing two USB host ports and a USB to dual RS232 converter. A guiding camera, mount and electric focuser can be connected directly to this camera instead of the computer to reduce cable clutter and the chance of signal loss due to the long cables. A single USB cable controls all of the peripherals.

Single 12V power socket

This camera uses a single 12V IN power port. The power socket is threaded for a solid connection that will not accidentally disconnect. There is another socket connected in parallel with the input that can be used to supply 12V OUT to other devices.

Butterfly Shutter - long life and uniform illumination

Although the sensor has electronic shutter, this camera also has a mechanical shutter. This makes it possible to automatically take dark frames, unattended. The shutter is directly driven by a motor with no other moving parts. The working life is almost unlimited. The shutter has two sides that block light and open spaces in between. The fan shape of the blades creates even-illumination when opening, and even-darkness when closing for dark frames. This feature is of great benefit when taking flat frames or making photometric measurements.

"A" Series Camera Connections

Guide Camera USB

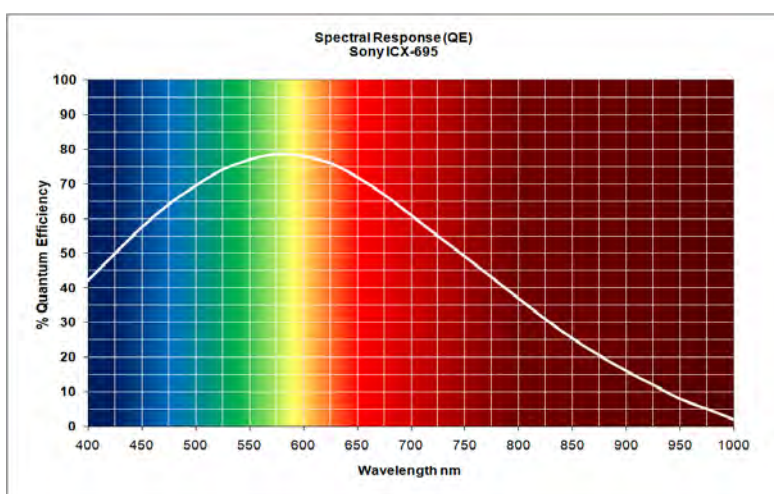
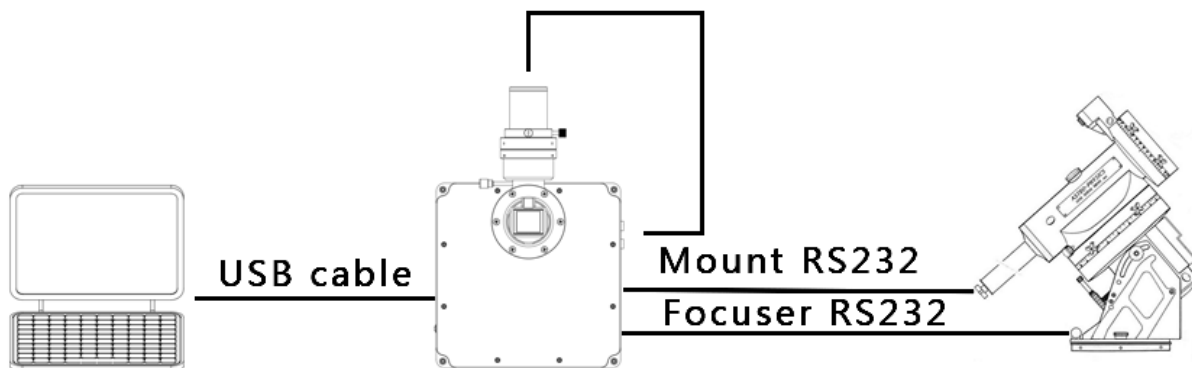

Model	QHY695A
Sensor	Sony ICX695 Mono
Optical Format	1-inch
Sensor Size	14.6mm x 12.8mm (19.4mm diagonal)
Total Active Pixels	6 Megapixels
Pixel Size	4.54um x 4.54um
Active Pixel Array	2758 x 2208
Cooling Delta T	-40C, Regulated
Read Noise	4e- to 5e- typical
Shutter	Electronic and Even-illumination mechanical for automatic dark frames
A/D Resolution	16-bit
Peak QE	79%
Full Well Capacity	15 – 20ke-
Computer Interface	USB 2.0
Weight	1550g
Reference Price	\$2899

Please note prices are subject to change without notice, please check with QHYCCD or your dealer for current prices



QHYCCD

QHY16200A 16MP APS-H Format Cooled CCD Camera



The **QHY16200A** uses a unique APS-H size CCD sensor, a product of close collaboration between QHYCCD and the sensor supplier. This sensor is specially designed and manufactured with amateur astronomers in mind who wanted a mono sensor larger than APS-C.

APS-H Format CCD Sensor: The effective image area is 27mm x 21.6mm. Compared to the QHY8L APS-C format of 23.4 x 15.8, the APS-H sensor is significantly larger with over 50% larger image area. The reason for desiring an APS-H size mono sensor is that there are no other existing mono sensors in size between the KAF-8300 (4/3inch) and the KAI-11002 (35mm format). This sensor has 16 Megapixels and the APS-H format is suitable for most telescopes, including SCT's that cannot fully illuminate a 35mm frame without some vignetting or distortion at the edges. It is also suitable for commonly available 2inch filters. The pixel size of this sensor is 6.0um x 6.0um, slightly bigger than the KAF-8300's 5.4um but, due to the larger size of the sensor, it has nearly twice as many pixels as the 8300. The QE is similar to or higher than 8300 and the 37ke- full well capacity is almost 50% greater than the 8300's 25.5ke-. Since the read noise is comparable to the 8300, the dynamic range can be calculated at about 1.5X greater than the 8300. This sensor also comes in a color version on request.

"A" Series Camera - Fully Integrated: The QHY16200A belongs to the new QHYCCD "A" series camera family. "A" stands for "ALL-IN-ONE". The camera includes a built-in motor driven filter wheel and natively supports the QHYOAG. The OAG can be installed on the camera solidly with six screws, consuming a minimum of back focus, precious for some optical systems. The filter wheels available for the QHY16200A accept 2" mounted filters, or 50mm unmounted round filters, in carousels with 5 or 7 positions. The camera is compatible with the medium size QHYOAG. In addition to the filter wheel and OAG, this "A" series camera offers an internal USB HUB (2.0) that provides two USB host port and a USB to dual RS232 converter. A guiding camera, mount and electric focuser can be connected directly to the camera instead of the computer to reduce cable clutter and the chance of signal loss due to the long cables. Only a single USB cable is needed to control all the peripherals.

Butterfly Shutter - long life, uniform illumination and automatic dark frames: This camera uses a mechanical shutter that has a butterfly shape. The shutter is directly driven by a motor with no other moving parts. The working life is almost unlimited. The shutter has two sides that block light and open spaces in between. The fan shape of the blades create even-illumination when opening, and even-darkness when closing for dark frames. This feature is of great benefit when taking flat frames or making photometric observations.

"A" Series Camera Connections

Guide Camera USB

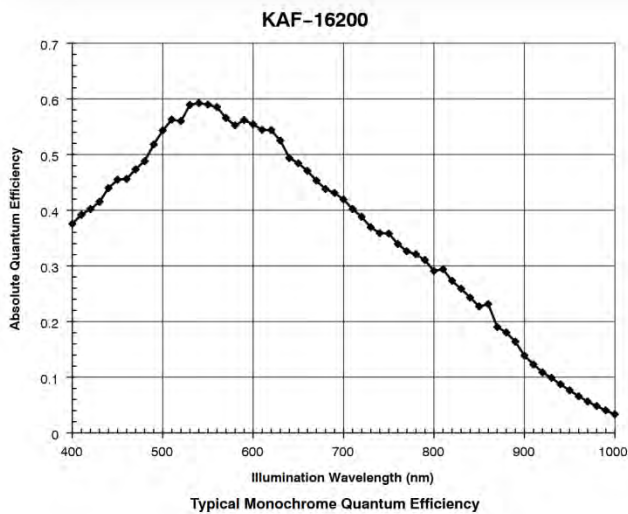
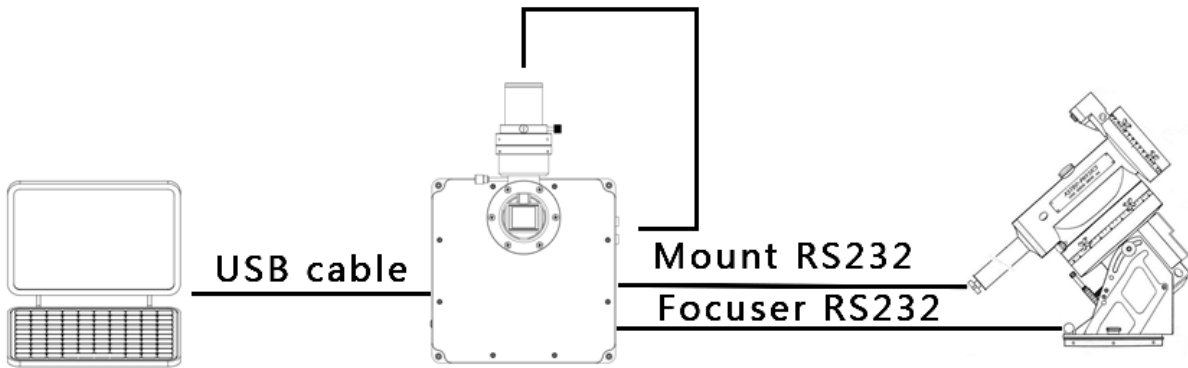

Model	QHY16200A
Sensor	On Semiconductor (Kodak) Truesense KAF-16200 CCD
Optical Format	APS-H
Sensor Size	27mm x 21.6mm (34.6mm diagonal)
Total Active Pixels	16.2 Megapixels
Pixel Size	6um x 6um
Active Pixel Array	4500 x 3600
Cooling Delta T	-40C
Read Noise	10e-
Shutter	Even Illumination Mechanical Shutter
A/D Resolution	16-bit
Dark Current	0.04e-/pixel/sec @ -20C
Full Well Capacity	41ke-
Computer Interface	USB 2.0
Weight	1550g with 5-position FW, 2330g with 7-position FW
Reference Price	\$3999 (5-position FW+OAG, \$4399 (7-position FW+OAG)

Please note prices are subject to change without notice, please check with QHYCCD or your dealer for current prices



QHYCCD

QHY16803A/09000A 645 Optical Format Cooled CCD Cameras

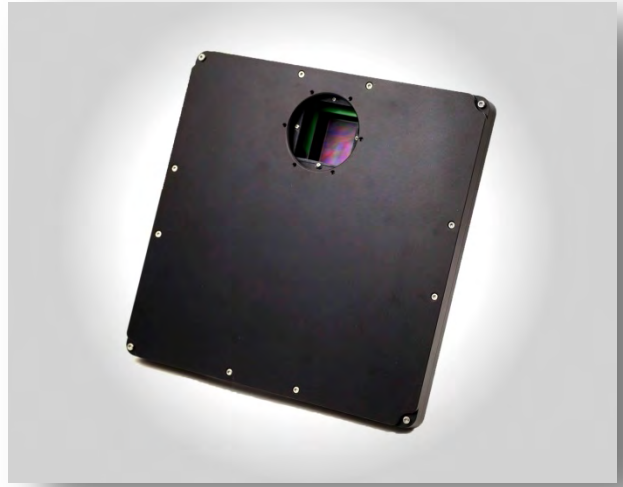

The **QHY16803A** and **QHY09000A** cameras are large format astronomical CCD cameras using the well-known 16 Megapixel KAF-16803 CCD and 9.3 Megapixel KAF-09000 CCD, popular with both advanced amateurs and professionals. The image area is just over 36mm x 36mm for both sensors. Both cameras use an even-illumination mechanical shutter for photometric quality darks and flats. This shutter is operated by direct drive and has an extraordinarily long life with no other moving parts.

The **KAF-16803 image sensor** is a redesigned version of the popular KAF-16801 image sensor (4096 (H) x 4096 (V) pixel resolution), with enhancements that specifically target the needs of high performance applications. Improvements include enhanced quantum efficiency for improved DQE at higher spatial frequencies, lower noise for improved contrast in areas of high density, and anti-blooming protection to prevent image bleed from over exposure in regions outside the area of interest. The sensor utilizes the TRUESENSE Transparent Gate Electrode to improve sensitivity compared to the use of a standard front side illuminated polysilicon electrode, as well as microlenses to maximize light sensitivity. When combined with large imaging area and small pixel size, the KAF-16803 provides the sensitivity, resolution and contrast necessary for high quality digital astro-images.

The **KAF-09000 image sensor** combines high resolution with outstanding sensitivity. The KAF-09000 image sensor has been specifically designed to meet the needs of next-generation low cost scientific imaging systems. The high sensitivity available from 12-micron square pixels combines with a low noise architecture to allow system designers to improve overall image quality. The excellent uniformity of the KAF-09000 image sensor improves overall image integrity by simplifying image corrections, while integrated anti-blooming protection prevents image bleed from over-exposure in bright areas of the image. The sensor utilizes the TRUESENSE Transparent Gate Electrode to improve sensitivity compared to the use of a standard front-side illuminated polysilicon electrode.

"A" Series Camera - Fully Integrated: The QHY16803A and QHY09000A belong to the new QHYCCD "A" series camera family. "A" stands for "ALL-IN-ONE". The cameras include a built-in motor driven filter wheel and natively support the large size QHYOAG. The OAG can be installed on the camera solidly with six screws, consuming a minimum of back focus, precious for some optical systems. The built-in filter wheel has 7 positions for 50mm square filters. The "A" series cameras have an internal USB HUB(2.0) that provides two USB host port and a USB to dual RS232 converter. A guiding camera, mount and electric focuser can be connected directly to the camera instead of the computer to reduce cable clutter and the chance of signal loss due to the long cables. Only a single USB cable is needed to control all the peripherals.

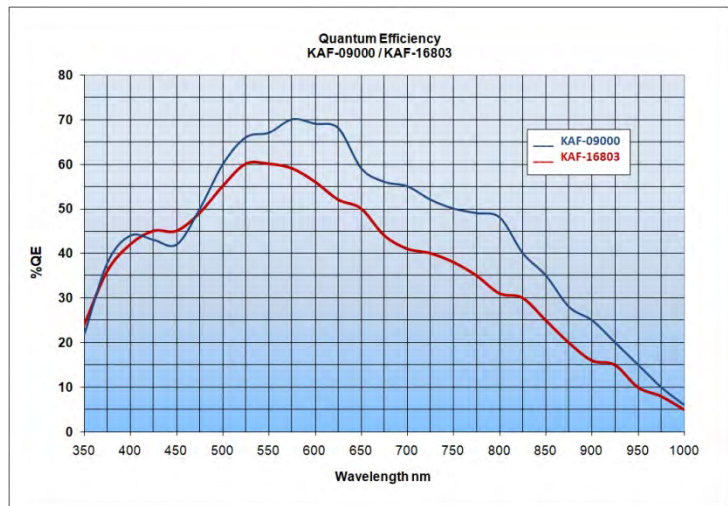
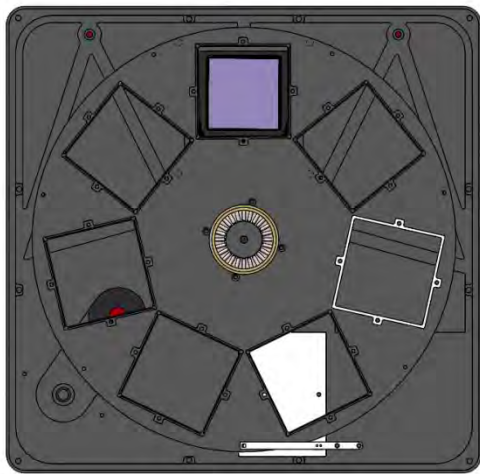

Model	QHY16803A	QHY09000A
Sensor	On Semiconductor (Kodak) Truesense KAF-16803 CCD	On Semiconductor (Kodak) Truesense KAF-09000 CCD
Optical Format	645 Medium Format	645 Medium Format
Sensor Size	36.87 x 36.8mm	36.7 x 36.7mm
Total Pixels	16.8 Megapixels	9.3 Megapixels
Pixel Size	9um	12um
Pixel Array	4096 x 4096	3056 x 3056
Cooling Delta T	-40C	-40C
Read Noise	13e-	11e-
Shutter	Even-illumination Mechanical Shutter	Even-illumination Mechanical Shutter
A/D Resolution	16-bit	16-bit
Dark Current	<0.05e-/p/s @ -15C	<0.05e-/p/s @ -20C
Full Well Capacity	100ke-	110ke-
Computer Interface	USB 2.0	USB 2.0
Weight	3121g	3121g
Reference Price	\$9500 with OAG, \$9900 with OAG and 7-Position Filter Wheel	\$9500 with OAG, \$9900 with OAG and 7-Position Filter Wheel

Please note prices are subject to change without notice, please check with QHYCCD or your dealer for current prices



QHYCCD

QHY miniCAM5F/6F Affordable, Cooled Multi-Spectrum Cams

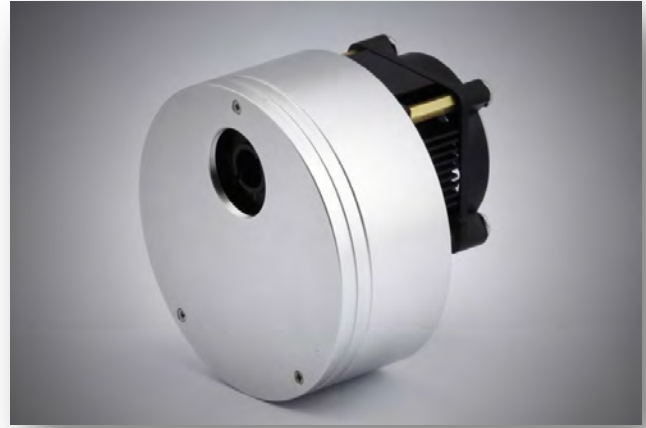

miniCAM5F

Cooled CMOS Camera with Built-in 9-Position Filter Wheel

The miniCAM5F is a highly-sensitive, cooled, CMOS camera with a built-in nine position motor driven filter wheel. This feature-rich camera includes regulated two-stage TE cooling that can lower the sensor temperature to -38C below ambient. The sensor has a peak QE of 74%. And the 1.2 Megapixel camera is capable of capturing full 1280x960 pixel images at 30 frames per second, or 320x240@200FPS, with extremely low read noise of 2 electrons! You can install the L, R, G, B, Ha, OIII, SII, CH4 and a black filter (for dark frame capture) all on the same filter carousel. Since the miniCAM5F utilizes our smaller, QHYCCD-defined, 12mm mini filter size, you'll save a lot. The miniCAM5F can be bundled with L, R, G, B filters, as well as the optional Ha, OIII, SII, H-beta and CH4 filters for just USD50 each. We believe these filters will be a lot of fun to play with not only for your planetary imaging but also for capturing your favorite DSOs! The camera comes with a 1.25-inch C-thread T-ring used to connect to the telescope. The 1.2 Megapixel CMOS sensor is very suitable for capturing smaller objects like planetary nebulae, small galaxies and globular clusters. If you have a short focal length OTA, it is also ideal for big, diffused nebulae. The miniCAM5F is a really mini camera, so it is excellent for building a compact imaging system.

NEW! miniCAM6F

Cooled CMOS Camera with Built-in 20-Position Filter Wheel and Internal Image Storage

The miniCAM6F is a highly sensitive, cooled, CMOS camera with a built-in twenty position filter wheel for multi-spectrum imaging with a 6 megapixel back-illuminated sensor and USB 3.0 interface. The two-stage TE cooling reaches to -50C below ambient. The filter wheel supports both 12mm and 12.5mm mini-filters (12.5mm is a standard size for many scientific filters). This camera has a very short 17.5mm backfocus distance and can be used with a C-mount lens. The miniCAM6F can internally record and store up to 1000 frames of a star image ROI (Region of Interest) for analysis of exoplanet investigation, occultations, atmospheric seeing measurements, focus analysis, optics analysis, etc.

Both models have full anti-moisture features, including a built-in heater board to prevent moisture from forming on the CMOS chamber window as well as the option to insert desiccant into the CMOS chamber when necessary.



Copernicus Colors Captured by Alain

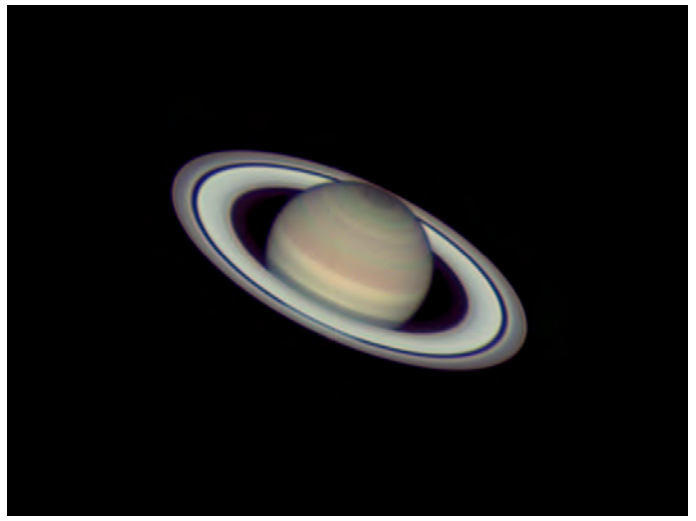

Saturn captured by Terry Lovejoy

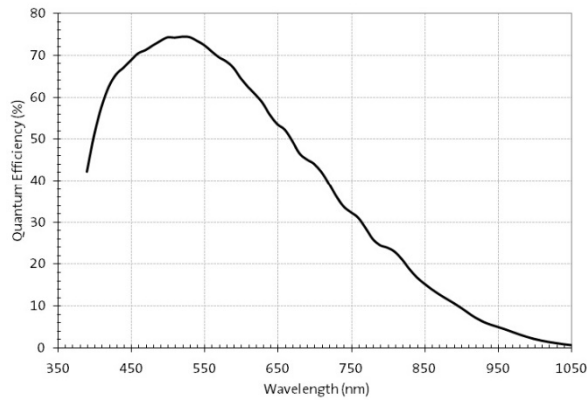

Model	miniCAM5F	miniCAM6F
Sensor	MT9M034	Sony IMX178
Optical Format	1/3 inch	1/1.8 inch
Sensor Size	4.8mm x 3.6mm	7.37mm x 4.92mm
Total Active Pixels	1.2 Megapixels	6.3 Megapixels
Pixel Size	3.75um x 3.75um	2.4um x 2.4um
Active Pixel Array	1280 x 960	3072 x 2048
Cooling Delta T	-38C Typical, Regulated	-50C, Regulated
Read Noise	2e- to 7e- typical	0.9e- to 2.4e-
Shutter	Electronic rolling shutter	Electronic rolling shutter
Exposure Time	10us – 1800sec	10us – 1800sec
Frame Rate	30 FPS@1280 x 960, 106 FPS@640 x 480	50FPS@full resolution
A/D Resolution	12-bit	14-bit
Peak QE	Mono 74%, Color 62%@540nm	TBD
Full Well Capacity	18ke-	15ke-
Computer Interface	USB 2.0	USB 3.0
Weight	672g	1313g
Reference Price	\$699 - \$949 depending on filter sets selected	TBD

Please note prices are subject to change without notice, please check with QHYCCD or your dealer for current prices



QHYCCD

QHYCFW3 Filter Wheels 1.25" to 50mm² Filters Dual QHY or USB Control



THE QHYCCD 3rd GENERATION FILTER WHEEL

New ultra-thin stepper motor drive and fully automatic filter switching revolutionizes overall performance!

NEW ULTRA-THIN HYBRID STEPPER MOTOR DRIVE

QHYCCD selected a high quality ultra-thin hybrid stepper motor for the 3rd generation filter wheel design. Compared to the PM stepper motor used in many filter wheels, the hybrid stepper motor has higher precision, smaller step angle, and is more expensive. The motor is enclosed to prevent dust from entering the motor, thus improving reliability and motor life. The direction of filter rotation can be reversed: The filter carousel can be rotated clockwise or counterclockwise to complete the rotation more quickly. The overall design is thinner.

FRICITION DRIVE WITH ZERO BACKLASH

Regarding the evolution of the motor drive, our 2nd generation filter wheels used a gear drive while this 3rd generation filter wheel uses an improved friction drive that results in zero backlash during operation. Filter positioning is more precise and faster.

USB / SERIAL PORT SWITCH

The USB / Serial Port switch can accommodate fast switching between serial communication mode and USB communication mode. The filter wheel supports the QHY 4-pin connection for direct control through a QHYCCD camera, or the filter wheel can be controlled independently through a USB port. The firmware is open source and compatible with Arduino. The design is also compatible with the QHY-OAG (off-axis guider) for the corresponding size.

BEAUTIFUL FINISH AND APPEARANCE

The QHYCFW3 main body is cut from a single piece of aluminum by a precision CNC machine. The craftsmanship and finish are exquisite. When you hold the small design, you do not want to put it down! A specially designed filter carousel allows the installation of unmounted filters of different thicknesses. Mounted Filters below 10 mm thick can be installed and unmounted filters of different thicknesses can also be mounted on the same filter disc.



The CFW3 filter wheels can all be controlled either through the QHY 4-Pin connection direct to a QHY camera or through a USB port. This makes the QHYCFW3 filter wheels adaptable to virtually any brand of camera.

Model	Carousel Configuration Supported	Filter Wheel Thickness	Maxium Filter Thickness	Weight
QHYCFW3S-US (thin)	6-Position, 36mm, or 7-Position, 1.25-inch	15.5mm	5.5mm	419g
QHYCFW3S-SR (standard)	6-Position, 36mm, or 7-Position, 1.25-inch	20mm	10mm	446g
QHYCFW3M-US (thin)	5-Position, 2-inch / 50mm round, or 7-Position, 36mm	17mm	5.5mm	691g
QHYCFW3M-SR (standard)	5-Position, 2-inch / 50mm round, or 7-Position, 36mm	20.5mm	10mm	728g
QHYCFW3L	7-Posiition, 2-inch / 50mm round	21.5mm	10mm	911g
QHYCFW3XL	9-Position, 2-inch / 50mm round, or 7-Position, 50mm square	21.5mm	10mm	1500g

Notes: 1.25-inch filters = filters in standard 1.25" OD threaded cells. 36mm filters = 36mm diameter round unmounted filters. 2-inch filters = filters in standard 2" OD threaded cells. 50mm round filters = 50mm to 50.8mm round unmounted filters. 50mm square filters = 50mm square unmounted filters. For mounted filter, the maximum thickness excludes the height of the cell threads.

Please refer to the latest QHYCCD price list or current website specifications for the current



QHYCCD

QHY PoleMaster Automatic Polar Alignment Accessory



PoleMaster - A High-Precision, Easy to Use Electronic Polar Scope

As any seasoned astroimager would agree, achieving good polar alignment is not an easy task. You may spend hours under precious dark sky trying to get that perfect polar alignment, but in the end you may not know whether good alignment has in fact been achieved. Even after you have obtained good alignment, a gentle knock on the mount may send the polar alignment off and you may have no other choice but to start from scratch again. With an hour here and an hour there trying to get polar aligned, it soon will be dawn and time to pack up the gear!

The PoleMaster is a great solution to this problem. The PoleMaster is an innovative product pioneered by QHYCCD to relieve the pain of polar alignment. Using PoleMaster and following a few simple, easy-to-follow, steps you can achieve perfect polar alignment in 2-3 minutes, with an accuracy of up to 30 arc seconds.

Background

How does PoleMaster work? The idea is actually fairly simple. You find out where the pole is, then determine the mechanical axis of rotation of your mount, and make the two coincide. While the idea is simple, it has never been implemented in a commercial product - until now. PoleMaster makes use of a super sensitive wide field imaging camera along the axis of RA to monitor the polar region in real time (it not only detects Polaris but also the dimmer stars surrounding Polaris). From the positions of these stars PoleMaster can determine the position of the true pole and compare that to the mechanical axis of RA rotation. Polar alignment is now a simple matter of moving the two centers of rotation so they overlap. Piece of cake!

In comparison with other polar alignment techniques, PoleMaster has the following advantage:

- 1. Speed and convenience:** With PoleMaster you do not need to move the telescope to a specific place just to unblock the polar scope. You do not need to kneel or contort your body to look through the polar scope. You do not need to fully dark adapt just to see the pole star. You do not need to level your mount. You do not need to worry about the entering the date and time in your handset and figure out where to rotate the mount to coincide with the current pole star position.
- 2. Accuracy:** With a high precision camera, one can achieve accuracy not achievable with the naked eye. The imaging camera in PoleMaster has a resolution of 30 arc second, so the best polar alignment that can be achieved by PoleMaster is also in the order of 30 arc seconds.
- 3. Wide angle view of the polar region:** A wide field of view of 11x8 degree makes it very easy to locate the pole star
- 4. Easy to install:** PoleMaster can be easily installed onto any equatorial mount through mount-specific adapters, even on mounts without a polar scope.
- 5. Real time polar alignment checking / adjustment:** By using PoleMaster you can monitor your polar alignment in real time. In the event that polar alignment is lost, it is now a simple matter to bring it back without having to start from scratch.
- 6. Three star alignment no longer needed:** Once you are polar aligned, you will only need to perform one star alignment - a real time saver.
- 7. Perfect companion to single axis mounts:** When used with single (RA-only) axis mount, good polar alignment will minimize drift in the DEC axis therefore maximizing the performance of your mount.

The QHYCCD PoleMaster is patented with the China Patent and International PCT. Please use only the genuine QHYCCD product.

QHYCCD OEMs: PoleMaster and iOptron. QHYCCD has granted a license to iOptron to display the iOptron logo on PoleMaster for use only with iOptron equatorial mounts. For other brands of mounts please use only the QHYCCD branded PoleMaster.

We installed the PoleMaster onto the EQ6, disabled RA and DEC pulse guiding and obtained this graph in PHD. The period is about 10 minutes. The DEC drift is very small. In a total of 30 minutes the DEC drift is about 1.5 arcsec. (Red line is DEC, Blue line is RA). This means the polar error is 18 arcsec.

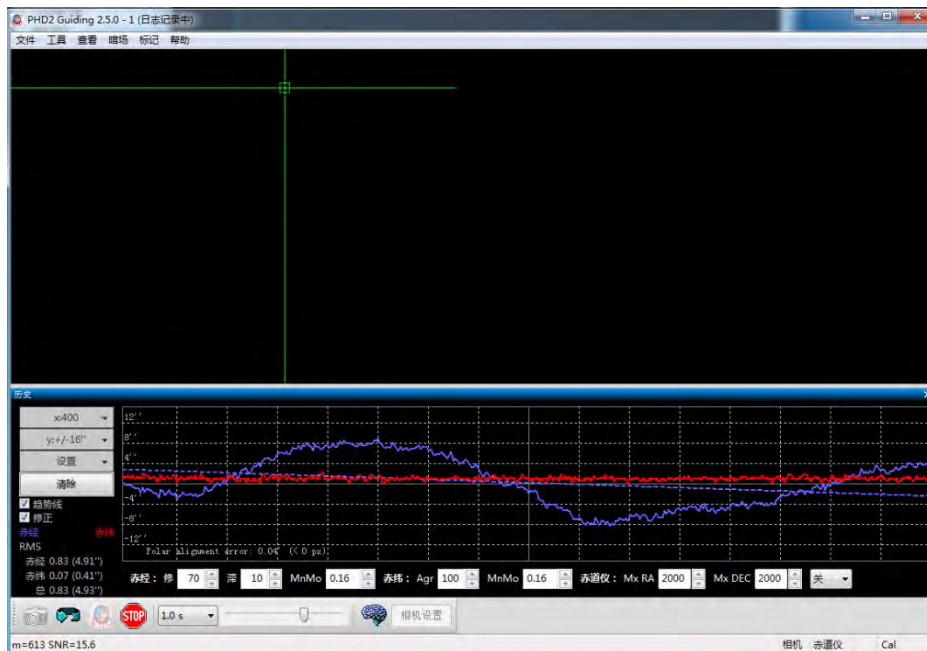

Southern Hemisphere Support

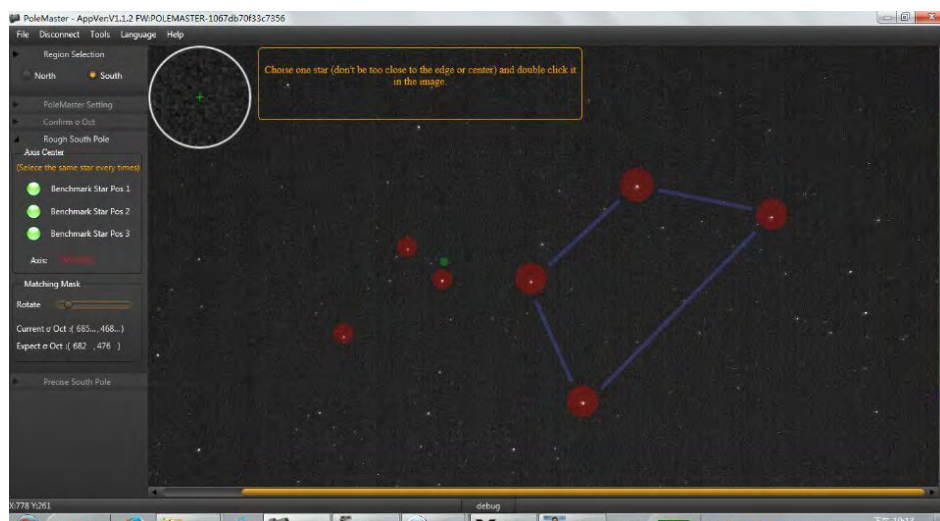
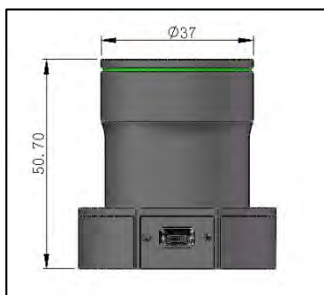

Model	PoleMaster
Field of View	11 degree x 8 degree
Resolution	Approximately 30 arcsec
Install method	Three M3 screw to mount adapter
Interface	mini USB2.0
Software	QHYCCD PoleMaster Software
Rough precision	Approx. 5 arcminutes
High Precision	Max 30 arcsec
Weight	115G
Dimensions	See mechanical drawing
Power Consumption	Approx. 0.35 Watts 70mA
Reference Price	\$268.00 (adapters additional: \$30 to \$45 depending on mount)
Available Adapters	EQ6/AZEQ6, HEQ5, iOptronCEM60, ZEQ25/CEM25, iEQ45, iEQ30, AZEQ5, Celestron AVX, CGEM, SX-4, TAK, MESU, SXP, UNC, EM200/EM11, EM400, EQ8, smart EQ, AP-SM, AP900, G11

Please note prices are subject to change without notice, please check with QHYCCD or your dealer for current prices



QHYCCD

New Product: **QHYCCD StarMaster** Integrated Control of Camera, Guider, Mount, Focuser, more.



The QHYCCD StarMaster is powered by StellarMate, a cross-platform astrophotography suite for Windows, MacOS, and Linux that supports highly accurate GOTO, autofocus and autoguide capabilities in addition to powerful image acquisition features and support for QHYCCD and other CCD and CMOS cameras, numerous mounts, DSLRs, focusers, and more. The QHYCCD StarMaster, powered by StellarMate includes numerous astro software features:

- Auto Hot Spot
- Equipment Profiles
- Modern Planetarium
- Versatile FITS Viewer
- Observation Planner
- Powerful Capture Tool
- Video Recording
- Field Rotator Support
- Smart Dark Library
- Sharp AutoFocus
- Powerful Guiding Capabilities
- Precision Astrometry
- Easy Polar Alignment
- Mount Modelling
- Dome Slaving
- Robotic Operation

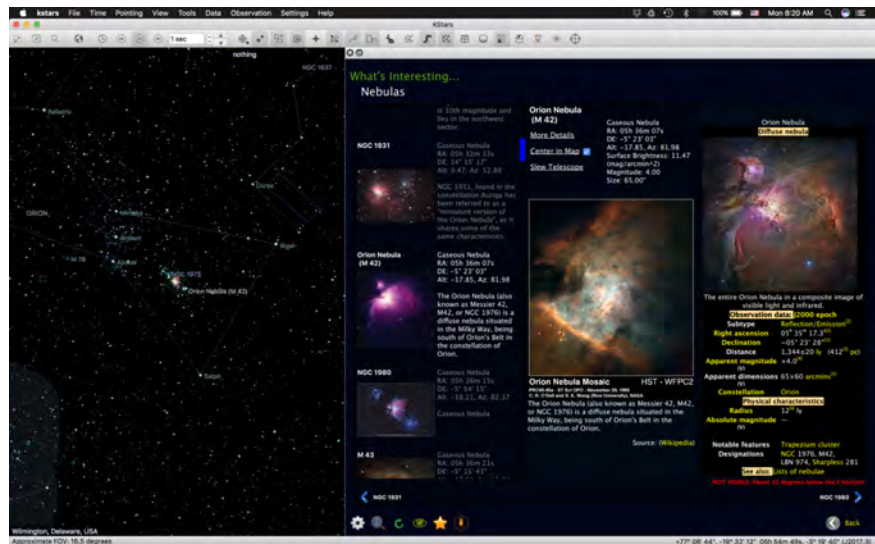

StarMaster is a complete observatory control and astrophotography solution. Connect your equipment to StarMaster and control them from anywhere. Equipped with 32GB of Class 10 MicroSD storage, you get high transfer speed and plenty of space for your high-res images! While you can use StarMaster with StellarMate without any computer, if you opt to control it from a computer, then it supports Ekos on Windows, MacOS, and Linux. Use the software on your own favorite platform. On mobile device you can use KStars Lite to control your equipment. . Also coming is a new App for both Android and iOS devices.

Since the StarMaster is powered by StellarMate, users have the benefit of Ekos and Kstar add-ons for full featured performance and support of a wide variety of equipment at no additional cost.

Coming Soon!

For more information please visit: <http://www.qhyccd.com>

Mini-Guide Scope

The miniGuideScope is an ultra-lightweight guide scope for QHY5-II Series Cameras. With small pixels and high QE, you do not need a big guide scope. Smaller pixels can detect the guide error in a shorter focal length scope. And, when the focal length is reduced, the FOV becomes larger, so it is easier to find bright guide stars. QHYCCD's new miniGuideScope is based on just this idea. The QHY5L-II has 74% high QE, 4e- readout noise and small 3.75um pixels. This camera is idea for a short focal length guide scope. The miniGuideScope is a 30mm f/4.3 (130mm FL) ultra-small telescope. It has no complex focal adjust system. Just rotate the front of the OTA and it provides fine focal adjustment. Once focus is achieved, the tube can be locked into position and there is not need to focus again unless the system is moved. The miniGuideScope provides pin-point star images as sharp as any lens in the industry.



Model	QHYOAG-L
Focal length	130mm
Aperture	30mm
F/ ratio	F/4.3
Camera Interface	C/CS mount
OTA diameter	31.6mm (Matches the QHY5-II series)
Focuser	Front portion of OTA rotates with digit mark and locking mechanism
Weight	120g
Focus Range	Infinity to 1.5m
Price	\$119 with no telescope mount adapter, \$139 with adapter, \$399 with QHY5L-II-M standard package and adapter

Please note prices are subject to change without notice, please check with QHYCCD or your dealer for current prices

OAG

There are three models of QHYOAG: QHYOAG-S, QHYOAG-M, and QHYOAG-L for different size sensors. The QHYOAG is a thin and solid design. The OAG main body is just 10mm thick. Adding an M42 thread or M54 adapter ring adds only 3mm for a total thickness of 13mm. There are six 3mm through holes in the OAG for direct connection to the QHYCFW2 and QHY "A" series cameras. If you do not have a QHYCFW2 or QHY "A" series camera, you can also use this OAG with a third-party adapter ring on the camera side. The QHYOAG comes with a multi-thread 1.25-inch focuser. The focuser has a locking thumbscrew to hold the guide camera fixed after focusing. The prism position can be adjusted and can be locked to fix its position. The prism is 8mm x 8mm size and the aperture between the prism and mirror is 8mm in diameter.



Model	QHYOAG-S	QHYOAG-M	QHYOAG-L
Telescope Adapter Ring	M42/0.75	M54/0.75	M60/0.75
Diameter of 6 x M3 screw locations	54mm	62mm	68mm
Compatible Device	QHY(IC)90A, QHY(IC)695A QHYCFW2-S	QHY(IC)16200A QHYCFW2-M	QHY(IC)16803 QHYCFW2-L
Suitable CCD SIZE	Up to 4/3 inch	APS-C, APS-H, 36x24	36x24mm, 37x37mm, 48x36mm (50100 requires special adapter)
Weight	127g	145g	149g
Price (without Tax)	USD180	USD230	USD280

Please note prices are subject to change without notice, please check with QHYCCD or your dealer for current prices

QHY Adapters

QHYCCD offers a wide variety of adapters to join together a camera, filter wheel, OAG, camera lens and/or telescope while maintaining the correct back focal distance required by the various optical components in the image train.

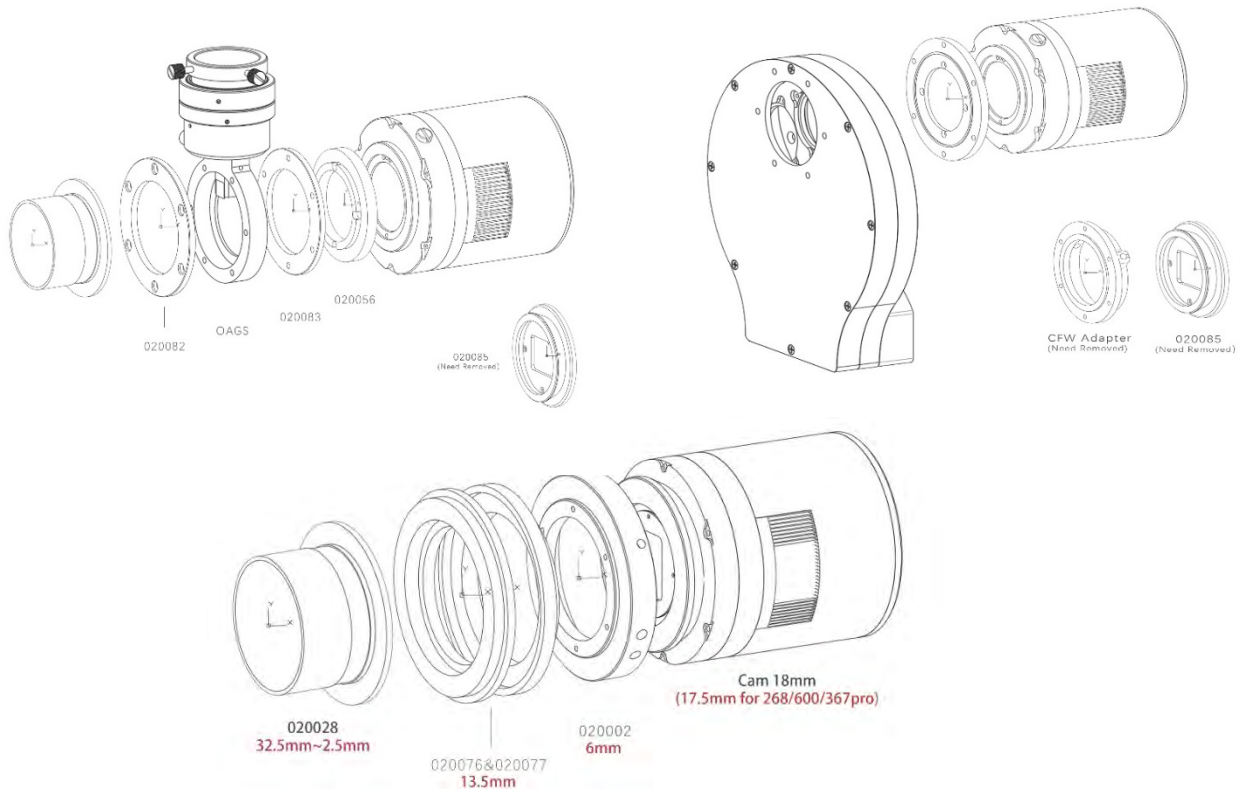

Tables of our various adapters with back focal distances and recommended connections can be found at www.QHYCCD.com -> Products -> Accessories -> Camera Adapters

Custom Adapters

QHYCCD has provided Precise Parts the technical specifications for QHY cameras and accessories in order to make creating custom adapters as efficient as possible. In many cases, users can create the custom adapter directly on the PreciseParts interactive website.

We are happy to partner with Precise Parts and encourage our users who need any special adapter that we do not have available to contact Precise Parts for their needs.

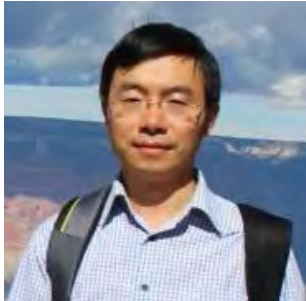

Table of QHY Cameras

Model	Sensor	Type	Format	MP	Size mm H	Size mm V	Pixels H	Pixels V	Pixel um	Mono/Color	Area mm ²	Diagonal mm	A/D	Illumination
Uncooled USB 2.0 Planetary Cameras and Guiders														
QHY5L-II	MT9M034	CMOS	1/3-inch	1.2	4.80	3.60	1280	960	3.75	Both	17.3	6.00	12	Front
QHY5P-II-M	MT9P006/P031	CMOS	1/2.5-inch	5.0	5.70	4.30	2592	1944	2.2	Mono	24.5	7.1	12	Front
Uncooled USB 3.0 Planetary Cameras and Guiders														
QHY5III224C	Sony IMX224	CMOS	1/3-inch	1.2	4.80	3.60	1280	960	3.75	Color	17.3	6.00	12	Front
QHY5III290	Sony IMX290	CMOS	1/2.8-inch	2.1	5.57	3.13	1920	1080	2.9	Both	17.4	6.39	12	Back
QHY5III178	Sony IMX178	CMOS	1/1.8-inch	6.3	7.37	4.92	3072	2048	2.4	Both	36.2	8.86	14	Back
QHY5III174	Sony IMX174	CMOS	1/1.2-inch	2.3	11.25	7.03	1920	1200	5.86	Both	79.1	13.27	12	Front
Cooled USB 3.0 CMOS Cameras														
QHY224C	Sony IMX224	CMOS	1/3-inch	1.2	4.80	3.60	1280	960	3.75	Color	17.3	6.00	12	Front
QHY290	Sony IMX290	CMOS	1/2.8-inch	2.1	5.57	3.13	1920	1080	2.9	Both	17.4	6.39	12	Back
QHY178	Sony IMX178	CMOS	1/1.8-inch	6.3	7.37	4.92	3072	2048	2.4	Both	36.2	8.86	14/16	Back
QHY550	Sony IMX250	CMOS	2/3-inch	5.0	8.50	7.09	2464	2056	3.45	Both	60.3	11.1	12/16	Front
QHY550P	Sony IMX250	CMOS	2/3-inch	5.0	8.50	7.09	2464	2056	3.45	Polarized	60.3	11.1	12/16	Front
QHY174	Sony IMX174	CMOS	1/1.2-inch	2.3	11.25	7.03	1920	1200	5.86	Both	79.1	13.27	12/16	Front
QHY174M-GPS	Sony IMX174	CMOS	1/1.2-inch	2.3	11.25	7.03	1920	1200	5.86	Mono	79.1	13.27	12/16	Front
QHY183	Sony IMX183	CMOS	1-inch	20.5	13.31	8.87	5544	3694	2.4	Both	118.0	15.99	12/16	Back
QHY2020	GSENSE2020	CMOS	1-inch	4.2	13.30	13.30	2048	2048	6.5	Mono	176.9	18.81	12/16	Back
QHY163	Panasonic	CMOS	4/3-inch	16.4	17.69	13.38	4656	3522	3.8	Both	236.8	22.18	12/16	Front
QHY294C	Sony IMX294	CMOS	4/3-inch	11.6	19.28	12.95	4164	2796	4.63	Color	249.6	22.86	14/16	Back
QHY247C	Sony IMX193	CMOS	APS-C	24.2	23.55	15.73	6024	4024	3.91	Color	370.6	28.33	14/16	Front
QHY165C	Sony IMX071	CMOS	APS-C	16.3	23.77	15.78	4952	3288	4.8	Color	375.1	28.53	12/16	Front
QHY168C	Sony IMX071	CMOS	APS-C	16.3	23.77	15.78	4952	3288	4.8	Color	375.1	28.53	14/16	Front
QHY268C	Sony IMX571	CMOS	APS-C	26.1	23.60	16.00	6280	4264	3.76	Color	377.6	28.50	16	Back
QHY42PRO	GSENSE400	CMOS	2-inch	4.2	22.53	22.53	2048	2048	11	Mono	507.5	31.86	12/16	Back
QHY128C	Sony IMX128	CMOS	2.7-inch	24.0	36.03	24.05	6036	4028	5.97	Mono	867.4	43.32	14/16	Front
QHY367C	Sony IMX094	CMOS	2.7-inch	36.4	35.99	24.10	7376	4938	4.88	Color	867.4	43.32	14/16	Front
QHY600	Sony IMX455	CMOS	2.7-inch	61.2	35.00	24.00	9600	6422	3.76	Both	868.0	43.3	16	Back
QHY4040	GSENSE4040	CMOS	3.3-inch	16.8	36.90	36.90	4096	4096	9	Mono	1361.6	52.18	12/16	Front
QHY4040 *	GSENSE4040	CMOS	3.3-inch	16.8	36.90	36.90	4096	4096	9	Mono	1361.6	52.2	12/16	Back
QHY461	Sony IMX461	CMOS	3.4-inch	104.0	44.20	33.40	11760	8896	3.76	Both	1476.3	55.4	16	Back
QHY411	Sony ICX411	CMOS	4.2-inch	151.0	53.36	40.00	14192	10640	3.76	Both	2134.4	66.69	16	Back
QHY6060 *	GSENSE6060	CMOS	61.4mm sq	37.7	61.4	61.4	6144	6144	10	Mono	3770.0	86.8	TBD	Front
QHY6060 *	GSENSE6060	CMOS	61.4mm sq	37.7	61.4	61.4	6144	6144	10	Mono	3770.0	86.8	TBD	Back
Cooled USB 2.0 CCD Cameras														
QHY22	Sony ICX694	CCD	1-inch	6.3	12.88	10.10	2838	2224	4.54	Mono	130.1	16.37	16	Front
QHY23	Sony ICX814	CCD	1-inch	9.5	12.80	10.07	3468	2728	3.69	Mono	128.8	16.28	16	Front
QHY09	On KAF8300	CCD	4/3-inch	8.0	18.13	12.94	3358	2396	5.4	Mono	234.6	22.28	16	Front
QHY8300	On KAF8300	CCD	4/3-inch	8.0	18.13	12.94	3358	2396	5.4	Mono	234.6	22.28	16	Front
QHY10	Sony ICX493	CCD	APS-C	10.8	23.98	16.41	3964	2712	6.05	Color	393.5	29.06	16	Front
QHY12	Sony ICX613	CCD	APS-C	14.7	23.76	16.18	4640	3160	5.12	Color	384.4	28.74	16	Front
QHY27	On KAI16050	CCD	APS-C	16.5	27.30	18.33	4964	3332	5.5	Mono	500.3	32.88	16	Front
QHY28	On KAI16070	CCD	2.7-inch	16.3	36.50	24.42	4932	3300	7.4	Mono	891.3	43.91	16	Front
QHY29	On KAI29050	CCD	2.7-inch	29.6	36.54	24.49	6644	4452	5.5	Mono	894.8	43.99	16	Front
QHY50GX	On KAF50100	CCD	3.5-inch	50.1	49.10	36.80	8176	6132	6	Mono	1806.9	61.30	16	Front
QHY45GX	On KAF4320	CCD	50mm sq.	4.2	50.02	50.02	2084	2085	24	Mono	2502.0	70.70	16	Front
Cooled USB 2.0 CCD All-in-One Cameras (Integrated Filter Wheel)														
QHY695A	Sony ICX695	CCD	1-inch	6.1	12.52	10.02	2758	2208	4.54	Mono	125.5	16.04	16	Front
QHY814A	Sony ICX814	CCD	1-inch	9.2	12.49	10.00	3384	2710	3.69	Mono	124.9	16.00	16	Front
QHY90A	On KAF8300	CCD	4/3-inch	8.0	18.13	12.94	3358	2396	5.4	Mono	234.6	22.28	16	Front
QHY16200A	On KAF16200	CCD	APS-H	16.5	27.24	21.78	4540	3630	6	Both	593.3	34.88	16	Front
QHY9000A	On KAF9000	CCD	36.8mm sq	9.3	36.80	36.80	3056	3056	12	Mono	1354.2	52.0	16	Front
QHY16803A	On KAF16803	CCD	36.8mm sq	16.0	36.80	36.80	4096	4096	9	Mono	1354.2	52.04	16	Front
Specialty Cameras														
miniCAM5F	MT9M034	CMOS	1/3-inch	1.2	4.80	3.60	1280	960	3.75	Mono	17.3	6.00	12	Front
miniCAM6F	IMX178	CMOS	1/1.8-inch	6.3	7.37	4.92	3072	2048	2.4	Color	36.2	8.86	14	Back

* In Development

QHYCCD Founder Dr. Qiu



CIRRICULUM VITAE SUMMARY

Dr. Qiu Hongyun was born in 1977 in Weiyuan City, Sichuan Province, China. He graduated from Weiyuan middle school in 1996 and attended Tsinghua University in Beijing where he received a BS degree in Materials Science in 2000. He continued his postgraduate studies at Tsinghua University and received a PhD in Optical Science and Engineering in 2007. In 2009 he founded Beijing Star Sense Scientific Co., Ltd., and was CEO from 2009 to 2012. The

company was renamed in 2012 to Light Speed Vision (Beijing) Co., Ltd., (QHYCCD). In 2013 Dr. Qiu was admitted to Harvard University for post-doctoral work and he moved to the United States from 2013 to 2015. His research topic was the design and structure of a light system for three dimensional imaging, and the implementation of noise reduction in both hardware and software. He applied low noise readout technology to the high speed CCD design for a high speed structured light system and worked with other group members to research the algorithm for noise reduction in the 3D image reconstruction and an increase in the precision of high speed real time 3D measurements. In 2015 he returned to Beijing where he remains today, working as CEO of Light Speed Vision (Beijing) Co., Ltd., (QHYCCD) designing and producing scientific CCD and CMOS cameras for astronomy, science and industry



[*Tsinghua University was ranked the best engineering university in the world by U.S. News & World Reports college rankings in 2015, beating out MIT for the first time.]*

HISTORY

From childhood Dr. Qiu Hongyun held a keen interest in nature, science and technology. As a young boy he would go to the chemical factory where his father worked and do chemistry experiments in the lab. He also enjoyed tinkering with electronics and made small board projects and a radio. In the 5th grade he read in a Science magazine about the approach of a comet. He tried to see the comet and although the toy binoculars he was able to find failed to be useful in spotting the comet, the effort and excitement of the event generated an interest in astronomy and that interest led to his making a small refractor telescope and later to attempt astrophotography with film. He had no camera only a homemade film holder. He would develop the film himself. By the time he was in Middle School, his interest in astronomy had grown. As a science project, he made an ultra-long zoom lens (about 800-3000mm) and got very good results with it. The lens earned him an award for invention and even an award for innovation his first year of University study.



By that time, however, Hongyun was becoming interested in electronic imaging for astronomy. In 1988 he joined the Amateur Astronomy Society of Tsinghua University and worked with other members making a 200mm Newtonian reflector. The telescope incorporated a mechanical system that would allow the secondary mirror to rotate to three

directions where they installed an eyepiece, a film camera, and a high sensitivity security video CCD camera. The telescope design brought the group a science & technology award. Even so, Hongyun was somewhat disappointed in the results that could be obtained with the video camera and he set his mind to find a way to improve the results of electronic imaging.

In 1999 Hongyun designed a LCD projector that could project a 100 inch TV image on a wall. At that time the biggest TV available in China was a 34 inch CRT. The 100 inch TV project generated a lot of interest in his University's campus innovation competition. He fondly remembers watching the Carl Sagan movie "Contact" and how the big screen gave such a deep impression when Jodi Foster went on her trip through the worm hole. His booth at the science fair was crowded with people wanting to see the large image. One of the visitors was another student who proposed setting up a team to produce the device. Hongyun agreed and that year the first entrepreneur team in China to be founded solely by the students born. The team became famous in China and received good funding; however, by that time Hongyun was in the midst of his PhD study and eventually left the team to return to the University to complete his PhD in optical engineering. He never lost his interest in astronomical imaging, though, and in 2003 he came across some interesting CCD sensors for sale in the electronics market.

The first sensors Hongyun found were the Sony ICX038 and ICX262. The ICX038 is a monochrome sensor with 0.4mega pixel and often used in security cameras. The ICX262 is a 3.3 Megapixel color CCD used in NIKON990 digital cameras. Since the consumer digital camera had appeared in China in 1999, and Hongyun happened to have one, he was excited to find that particular sensor at a reasonable price. Megapixel astronomy cameras were very expensive at that time, so relying on his experience with electronic design and his knowledge of astronomy, he began to design a new astro-camera, based first on the smaller CCD to work out the kinks, and later on the larger color sensor as a potential commercial project. The first camera set up for testing is seen in the picture at right. It worked, taking suitable images of a magnitude 7 comet using a 135mm f/3.5 camera lens. For the ICX262 based camera Hongyun added the ability to adjust the gain to suit the imaging and the design was very successful. The first long exposure color image was very beautiful and the Sony 3.3 Megapixel CCD's low dark current (SuperHAD technology) was an attractive feature. That was the year 2004.



Hongyun realized that although this first camera had 3.3 Megapixels, the pixels were very small, only 3.45um, which is too small at the time for SCT and other large scopes most amateurs were using for imaging. He hoped to design a camera optimized for these larger scopes. Nikon then released a DSLR with an APS-C sensor. The sensor was big enough and used 6 microns pixels. It also had high sensitivity and low dark current, but they proved difficult to get from Sony. The cameras were available at reasonable prices, so Hongyun planned to buy some new D50 cameras and take the CCD sensor out to make an camera with this sensor. It would be called the QHY8. Needless to say it became a hot product and QHY sold hundreds of QHY8, QHY8PRO and eventually released the QHY10 and QHY12 models. QHY had arrived in the amateur astronomy

imaging market to stay. Another reality of astro-imaging that did not escape Dr. Qiu's attention was the need for autoguiding, although the first QHY autoguider almost never was. While experimenting with CMOS for deep space imaging Dr. Qiu developed the QHY5. The CMOS sensor offered decent performance, high frame rates and low price. He experimented with both Omnivision and Micron CMOS and settled on the Micron MT9M001, 1.3 megapixel 1/2 inch sensor. It delivered 15fps to 30fps at full resolution and it came in a monochrome version. But it had a big problem - the sensor had unacceptable random horizontal noise, especially in high gain, which made it unusable for deep space imaging of faint objects. "I am a person who expects perfection, especially in the hardware design, camera performance and image quality." So the decision was made to relegate the QHY5 design to the trash bin and move on to something else.

However, before killing the project, Craig Stark of Stark Labs happened to mention that he was developing autoguiding software called PHD Guiding and he thought the QHY5 could be used for autoguiding instead of imaging because the random horizontal banding might not affect the result for guiding purposes. Testing confirmed this and the QHY5 autoguider was born! Due to its positive features, like good sensitivity and high resolution, plus the low price, the QHY became one of the hottest autoguiders, selling thousands each year, and still available in OEM products.

From these humble beginnings, QHYCCD has grown to a leading supplier of cooled CCD and CMOS cameras for science and industry, with a current offering of approximately 40 models and configurations of cameras, filter wheels, guiders, and other accessories for astronomical imaging. And from the modest small CCDs and APS sized sensors, QHYCCD now supplies cameras with sensors up to 50 Megapixels, and up to 70mm diagonal size, plus several 35mm format cameras and scores of smaller sized sensors, including both front and back illuminated CMOS sensors with over 90% QE.



For more information please visit <http://www.qhyccd.com>

