

Unibrain Ultra Compact firewire cameras

Models: 530/550/630/830/850

User Operation Manual

Version 2.0

April 2012

unibrain
The 1394 Innovators

Legal Notice

For Customers in U.S.A.

This equipment has been tested and found to comply with the limits for a Class B digital device, pursuant to Part 15 of the FCC Rules. These limits are designed to provide reasonable protection against harmful interference when the equipment is operated in a commercial environment. This equipment generates, uses, and can radiate radio frequency energy and, if not installed and used in accordance with the instruction manual, may cause harmful interference to radio communications. Operation of this equipment in a residential area is likely to cause harmful interference in which case the user will be required to correct the interference at their own expense. You are cautioned that any changes or modifications not expressly approved in this manual could void your authority to operate this equipment. The shielded interface cable recommended in this manual must be used with this equipment in order to comply with the limits for a computing device pursuant to Subpart J of Part 15 of FCC Rules.

For customers in Europe

This apparatus has been certified to meet or exceed the standards for CE compliance per the Council Directives. Pertinent testing documentation is available for verification.

For customers in Canada

This apparatus complies with the Class B limits for radio noise emissions set out in the Radio Interference Regulations.

Pour utilisateurs au Canada

Cet appareil est conforme aux normes Classe B pour bruits radioélectriques, spécifiées dans le Règlement sur le brouillage radioélectrique.

Life support applications

These products are not designed for use in life support appliances, devices, or systems where malfunction of these products can reasonably be expected to result in personal injury. Allied customers using or selling these products for use in such applications do so at their own risk and agree to fully indemnify allied for any damages resulting from such improper use or sale.

Before You Start

This manual should help you in installation and setting of the camera and we recommend you to carefully follow the instruction described.

To ensure that your warranty remains valid, read the manual carefully before using the camera.

DO NOT disassemble, modify or repair the camera since there is no user serviceable part inside and may void warranty. For prevention of fire or electric shock DO NOT remove screws or cover from the camera.

Operation in wet area is NOT recommended and camera SHOULD NOT be exposed to rain or moisture. For prolong life and use of camera's CCD, do not point the camera directly to the sun or strong spotlight which may result CCD blooming and permanent damage. DO NOT operate camera beyond operation temperature range stated and AVOID usage in conditions exceeding 90% humidity.

DO NOT use unregulated power supply source to prevent camera's circuit damage.

Use soft materials such as lens tissue or cotton tipped applicator with ethanol for CCD faceplate cleaning ONLY when necessary and AVOID contact with fingers or any hard object. Do not use solvent, abrasives or detergent in case of cleaning camera body.

Warranty shall be voided for improper usage or fault caused by user or damage caused by other equipments due to negligence

Warranty

Unibrain warrants the original components free of defects for one year from purchase date. This warranty covers failures and damage due to defect which may occur during normal use. It does not cover damages or failure resulting from mishandling, abuse, misuse or modification. For every repair or replacement, RMA numbers must be obtained in advance.

Disclaimer

The information in this document has been carefully checked and is believed to be reliable. However, no responsibility is assumed for inaccuracies, nor is any responsibility assumed by Unibrain. There is no legal obligation to documenting internal relationships in any functional module of its products, which is realized in either hardware or software.

Copyright

All the materials in this document are protected by copyright and other laws for intellectual property. They are not allowed to be copied, reproduced or modified for any use without the permission of Unibrain. Unibrain reserves the right to make changes in specifications, functions or designs at any time and without any notice. The company names in this document may be the trademarks and trade-names of their respective owner and are hereby acknowledged.

Copyright © 2012 Unibrain. All rights reserved.

Table of contents

1.	Introduction.....	1
1.1.	Overview.....	1
1.2.	Dimensions and Description.....	2
1.3.	Camera Interface.....	3
1.4.	Firewire Port.....	4
1.4.1.	Trigger Connector Port	4
1.4.2.	Status LED	4
1.5.	Electrical Operating Condition.....	5
1.6.	Pixel Data.....	7
2.	Camera Specifications	10
2.1.	Monochrome cameras	10
2.1.1.	Fire-i 830b Specification	10
2.1.2.	Fire-i 630b Specification	11
2.1.3.	Fire-i 530b Specification	12
2.1.4.	Fire-i 550b Specification	13
2.2.	Color Cameras	14
2.2.1.	Fire-i 830c Specification	14
2.2.2.	Fire-i 630c Specification	15
2.2.3.	Fire-i 530c Specification	16
2.2.4.	Fire-i 850c Specification	17
2.2.5.	Fire-i 550c Specification	18
2.3.	Spectral Sensitivity.....	19
2.3.1.	B&W Cameras.....	19
2.3.2.	Color Cameras	21
3.	Basic Operation and Features.....	24
3.1.	Brightness.....	24
3.2.	Auto Exposure Control	25
3.3.	Sharpness	26
3.4.	White Balance	26

3.5.	Hue	27
3.6.	Gamma	27
3.7.	Shutter	28
3.7.1.1.	Fire-i x3x models (530, 630, 830)	28
3.7.1.2.	Fire-i x5x models (550, 850).....	29
3.8.	Gain.....	30
3.8.1.1.	Fire-i x3x models (530, 630, 830)	30
3.8.1.2.	Fire-i x5x models (550, 850).....	30
3.9.	Trigger & Strobe	30
3.9.1.	Supported Trigger	30
3.9.1.1.	Fire-i x3x models (530, 630, 830)	30
3.9.1.2.	Fire-i x5x models (550, 850).....	30
3.9.2.	Trigger and Strobe Signal Relation	32
3.9.2.1.	Fire-i 530, 630, 830	32
3.9.2.2.	Fire-i 550, 850	33
3.9.2.3.	Trigger Timing Diagram for Fire-i 550, 850	34
3.9.2.4.	Timing Diagram for External Trigger and Shutter and Strobe	35
Fire-i 530, 630, 830		35
3.9.3.	Trigger and Strobe delay	35
3.9.4.	Trigger Mode 0	36
3.9.5.	Trigger Mode 1	36
3.9.6.	Trigger Mode 2	36
3.9.7.	Trigger Mode 3	37
3.9.8.	Trigger Mode 4	37
3.9.9.	Trigger Mode 5	38
3.9.10.	Trigger Mode 14.....	38
3.9.11.	Trigger Mode 15.....	38
3.10.	Strobe Control Register	40
3.11.	Trigger Delay Control	42
3.12.	Optical Filter Control	44
3.13.	Color (Bayer) Patterns Conversion.....	45

4. Advanced Features 46

4.1.	Binning Mode	46
4.1.1.	Vertical Binning.....	46
4.1.2.	Horizontal Binning.....	46
4.1.3.	Full Binning	47
4.2.	Partial Scan	48
4.3.	Pan/Tilt	49
4.4.	One-Shot and Multi-Shot	51
4.5.	Multi-Camera Auto-sync.	52
4.6.	Asynchronous Broadcasting.....	52
4.7.	Memory Channel Save / Load.....	53
4.8.	Time Stamp Register.....	54
4.9.	Serial Interface	55
4.9.1.	SIO Pass Through Scheme	55
4.9.2.	SIO(RS232) Registers.....	58
4.9.3.	SIO(RS232) Special Commands	60
4.10.	Frame Save Function.....	62
4.11.	LUT (Lookup table)	63
4.11.1.	4 step knee lookup table	63
4.11.2.	User defined lookup table.....	63
4.12.	One Pixel Snow Noise Remove.....	65
4.13.	PIO Control Register	66

5. User Defined (custom) FIREWIRE Registers..... 67

5.1.	User Defined FIREWIRE Address	67
------	-------------------------------------	----

6. Video Formats and Modes..... 71

6.1.	Fire-i 830b / Fire-i 830c.....	72
6.2.	Fire-i 630b / Fire-i 630c.....	73
6.3.	Fire-i 530b / Fire-i 530c.....	73
6.4.	Fire-i 850c.....	74

6.5.	Fire-i 550b / Fire-i 550c.....	74
6.6.	Trouble Shooting	75
6.7.	Hardware Related Issues	75
6.7.1.	Camera is not recognized in the device manager	75
6.7.2.	LED is OFF while power is provided either by FireWire or external power.....	75
6.7.3.	No Image or Black Image is Displayed	75
7.	Technical Support	76

1. Introduction

1.1. Overview

Unibrain's **Fire-i ultra compact Industrial Firewire cameras (Bonsai) series** opens up a new horizon in digital image processing; by providing more features in a very small form factor while still maintaining excellent cost effectiveness and high quality. These models are comprised of a wide range of resolutions and are equipped with a FireWire interface and a trigger to suit the needs of every application. The **Bonsai series** offer the highest frame rate in each of its resolutions compared with other products currently available. The very small form factor design has expanded the implementation and broadens application areas by eliminating the limits that currently exist due to size and weight.

A selection of cameras is available which consist of sensors sizes (1/3", 1/1.8") and resolution (VGA, XGA, UXGA) both in color and black and white.

	Model Name	CCD	CMOS	Resolution	FPS at Max Res.
Black & White	Fire-i 830b	1/1.8"		1600x1200	16
	Fire-i 630b	1/3"		1024 x 768	36
	Fire-i 530b	1/3"		640 x 480	86
	Fire-i 550b		1/3"	752 x 480	60
Color	Fire-i 830c	1/1.8"		1600x1200	16
	Fire-i 850c		1/2"	2048x1536	10
	Fire-i 630c	1/3"		1024 x 768	36
	Fire-i 530c	1/3"		640 x 480	86
	Fire-i 550c		1/3"	752 x 480	60

Unibrain Bonsai camera series possess unique features that support external trigger mode 0~5 plus 14,15, multi camera auto-sync, one-shot and multi-shot, a wide range of shutter speed, RS232C pass through via FIREWIRE™, Fast format 7, partial scan, and a high speed up trigger frame rate, which would provide maximum flexibility in applications. Industrial Screw Lock cable support has been added for more reliable connectivity.

Software support

All cameras are fully supported from Unibrain's Fire-i™ drivers and software and embed a Fire-i API™ SDK license. Latest versions of Fire-i™ software and SDK can be downloaded from our web site: <http://www.unibrain.com/downloads/>

1.2. Dimensions and Description

Camera Body Size : 29 (w) x 29 (H) x 39(D) mm

Camera Body Weight: approx. 63 gram

Operation Temperature: -5°C ~ 45°C / Storage Temperature: -20°C ~ 65°C

Avoid operation in environment of high humidity over 90% and allow sufficient airflow for prevention of heat buildup.

Fire-i 530, 630, 830

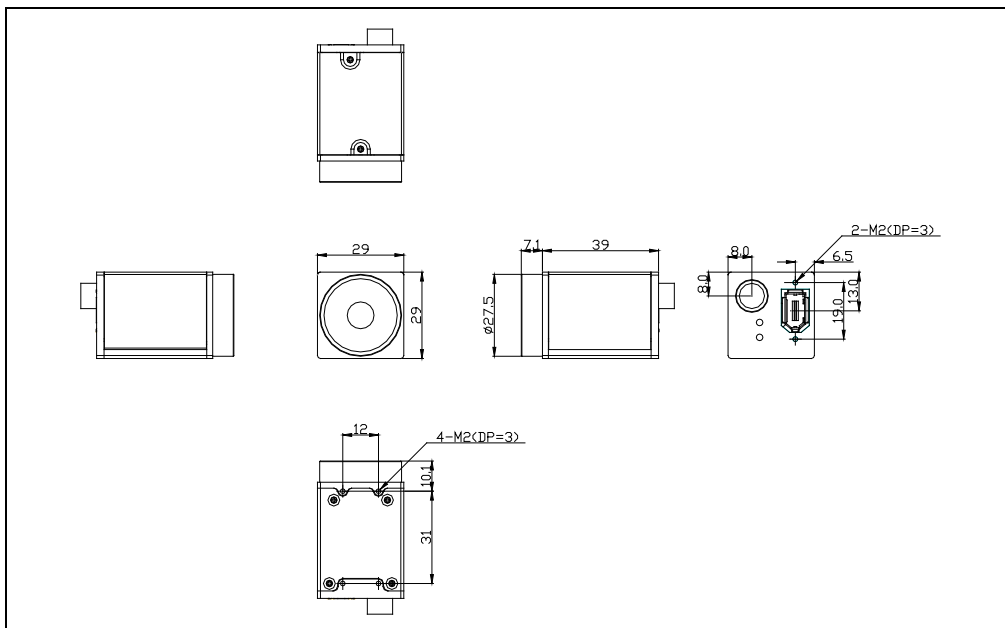

Fire-i 550, 850

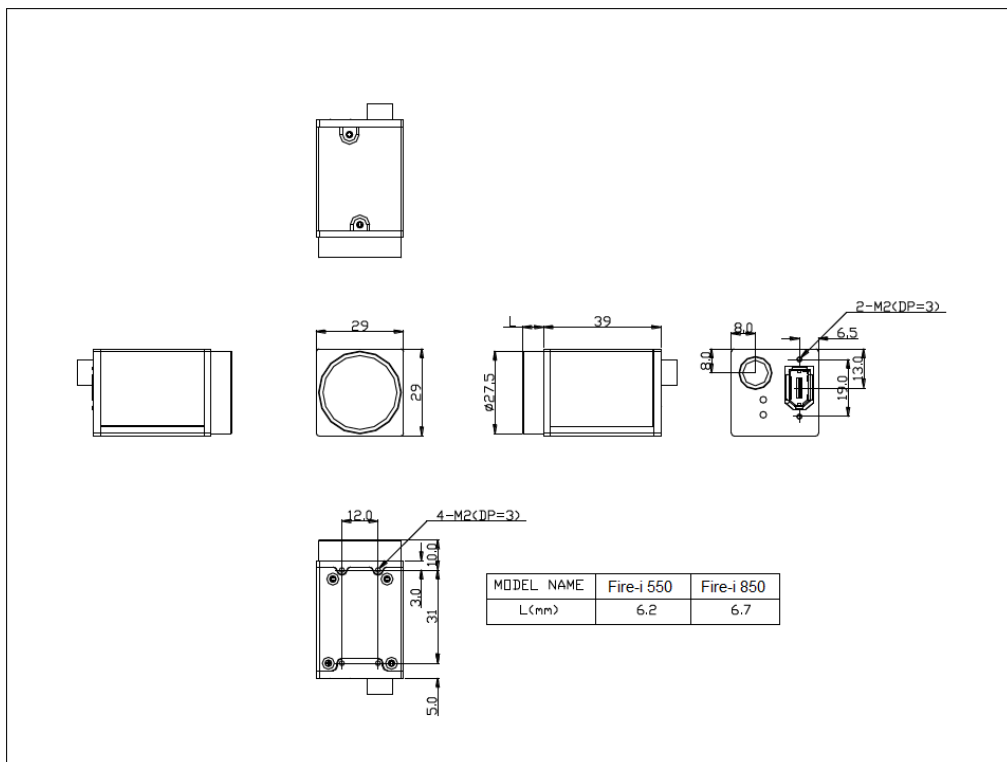

1.3. Camera Interface

The camera's interface is located on the back of the camera (assuming lens mount is front) as per the following.

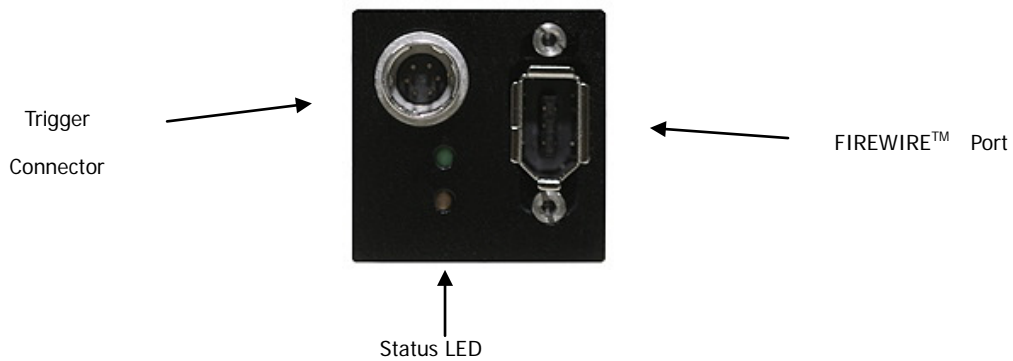

1.4. Firewire Port

The industry standard FireWire (IEEE-1394) port has the following pin assignment. Data and control of the camera and power are provided by the firewire port.

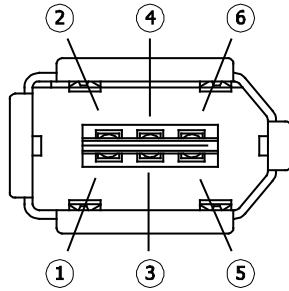

Pin	Signal
1	VP
2	VG(Ground)
3	TPB-
4	TPB+
5	TPA
6	TPA-

CAUTION: DO NOT reverse the polarity. This could result in damage to the camera.

1.4.1. Trigger Connector Port

External Trigger Connector provides the access to multiple I/O.

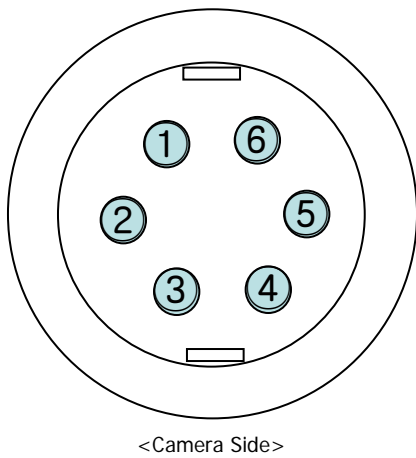

Pin	I/O	Signal Name
1	O	TX232
2	I	RX232
3	X	NC
4	O	Strobe
5	I	Ext. Trigger
6	I	GND

Note: NC pins must have no connection

1.4.2. Status LED

LED Status	Isochronous channel	Packet Transfer
RED	Disable	NO
GREEN	Enable	YES
OFF	Enable	NO

Remark: Also when power off, LED is OFF

1.5. Electrical Operating Condition

Trigger

Recommended Trigger Example 1

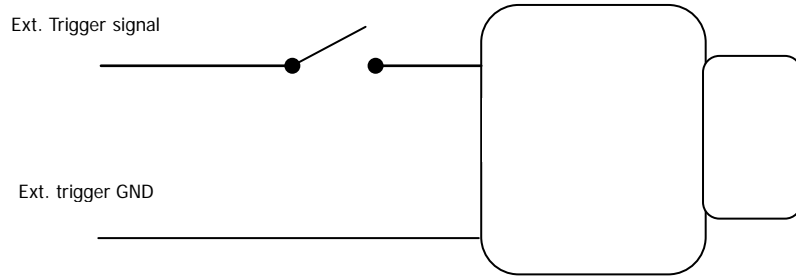

Recommended Trigger Example 2

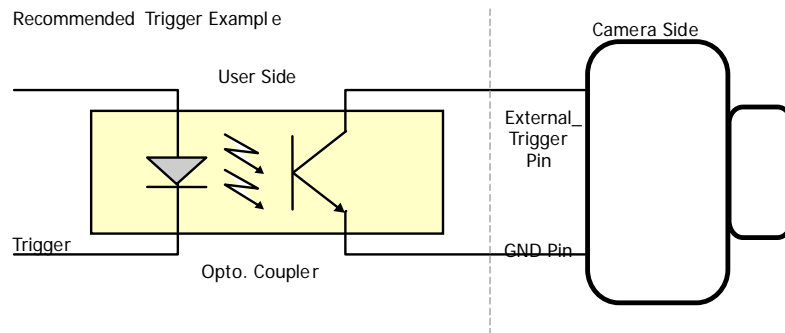

Electrical Specification

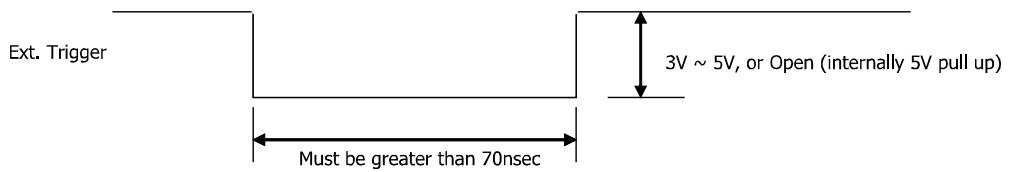

Strobe

Recommended Strobe Example 1

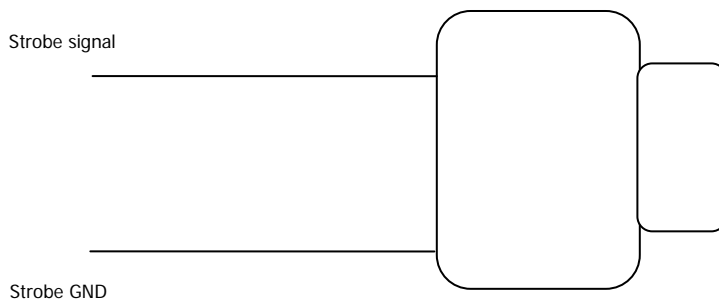

Recommended Strobe Example 2

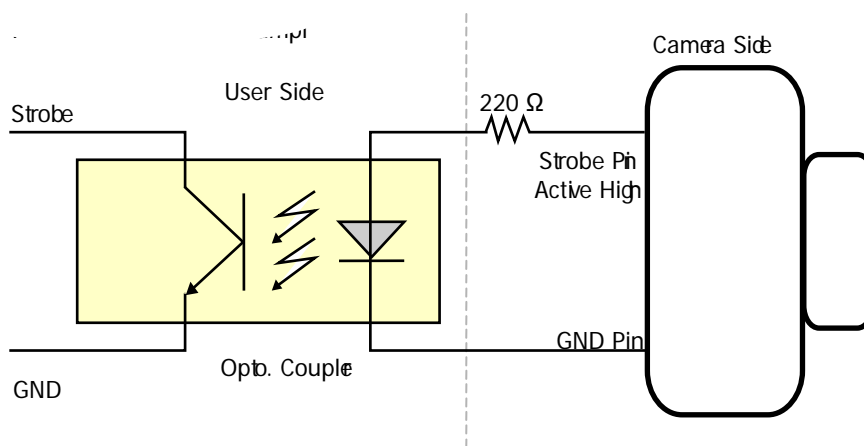

Electrical Specification

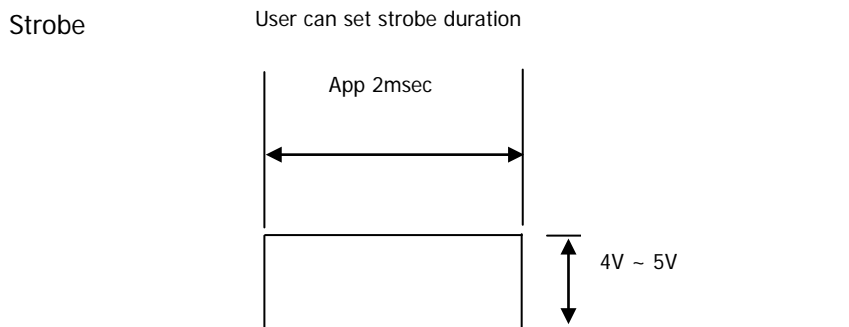

1.6. Pixel Data

The **Unibrain Fire-i ultra compact form Series** complies with the IIDC 1394-Based Digital Camera Specification V1.31 where data packets are transmitted by a FireWire™ interface as isochronous packets. Every video format, mode and frame rate has a different video data format. (Pixel data source: IIDC V1.31 Specification)

Isochronous Data Block Packet Format

0 - 7	8 - 15	16 - 23		24 - 31	
Data Length		tg	channel	tCode	Sy
Header CRC					
Video data payload					
Data CRC					

Where the following fields are defined in the IEEE 1394 standard as:

Data length: number of bytes in the data field **tg:** (tag field) shall be set to zero

channel: isochronous channel number, as programmed in the *iso_channel* field of the *cam_sta_ctrl* register

tCode: (transaction code) shall be set to the isochronous data block packet tCode

sy: (synchronization value) shall be set to 0001h on the first isochronous data block of a frame, and shall be set to zero on all other isochronous data blocks

Video data payload: shall contain the digital video information, as defined in the following sections of the

Video data Payload Structure

Pn : Pixel number / packet
 K : Pn x n (n = 0.....N-1)
 (Pn x N = Total pixel number /frame)

<YUV (4: 2: 2) format >

U-(K+0)	Y-(K+0)	V-(K+0)	Y-(K+1)
U-(K+2)	Y-(K+2)	V-(K+2)	Y-(K+3)
U-(K+4)	Y-(K+4)	V-(K+4)	Y-(K+5)
U-(K+Pn-6)	Y-(K+Pn-6)	V-(K+Pn-6)	Y-(K+Pn-5)
U-(K+Pn-4)	Y-(K+Pn-4)	V-(K+Pn-4)	Y-(K+Pn-3)
U-(K+Pn-2)	Y-(K+Pn-2)	V-(K+Pn-2)	Y-(K+Pn-1)

<YUV (4: 1: 1) format >

U-(K+0)	Y-(K+0)	Y-(K+1)	V-(K+0)
Y-(K+2)	Y-(K+3)	U-(K+4)	Y-(K+4)
Y-(K+5)	V-(K+4)	V-(K+4)	Y-(K+5)

U-(K+Pn-8)	Y-(K+Pn-8)	Y-(K+Pn-7)	V-(K+Pn-8)
Y-(K+Pn-6)	Y-(K+Pn-5)	U-(K+Pn-4)	Y-(K+Pn-4)
Y-(K+Pn-3)	V-(K+Pn-4)	Y-(K+Pn-2)	Y-(K+Pn-1)

<Y(Mono) Format >

Y-(K+0)	Y-(K+1)	Y-(K+2)	Y-(K+3)
Y-(K+4)	Y-(K+5)	Y-(K+6)	Y-(K+7)
Y-(K+Pn-8)	Y-(K+Pn-7)	Y-(K+Pn-6)	Y-(K+Pn-5)
Y-(K+Pn-4)	V-(K+Pn-3)	Y-(K+Pn-2)	Y-(K+Pn-1)

<Y(Mono) Format >

High Byte	Low Byte
-----------	----------

Y-(K+0)	Y-(K+1)
Y-(K+2)	Y-(K+3)
Y-(K+Pn-4)	Y-(K+Pn-3)
V-(K+Pn-2)	Y-(K+Pn-1)

Data Structure

<Y, R, G, B >

Each component has 8 bit data. The data type is "Unsigned Char"

	Signal Level (Decimal)	Data (Hexadecimal)
Highest	255	0xFF
	254	0xFE
	.	.
	.	.
	1	0x01
Lowest	0	0x00

<U, V>

Each component has 8 bit data. The data type is "Straight Binary"

	Signal Level (Decimal)	Data (Hexadecimal)
Highest(+)	127	0xFF
	126	0xFE
	.	.
	.	.
	1	0x81
Lowest	0	0x80
	-1	0x7F
	.	.
	.	.
	-127	0x01
Lowest	-128	0x00

<Y (Mono16)>

Y component has 16 bit data. The data type is "Unsigned Short (big-endian)"

Y	Signal Level (Decimal)	Data (Hexadecimal)
Highest	65535	0xFFFF
	65534	0xFFFE
	.	.
	.	.
	1	0x0001
Lowest	0	0x0000

2. Camera Specifications

2.1. Monochrome cameras

2.1.1. Fire-i 830b Specification

Features		
Image Sensor Type	1/1.8-inch Interline CCD (Sony ICX274AL)	
Effective pixels	2,010,000 pixels 1628(H) x 1236(V)	
Picture Size	1600x1200, 1280x960, 1024x768, 800x600, 640x480	
Cell Size(um)	4.4 x 4.4	
Real Frame Rate	15, 7.5, 3.75, 1.875 / Y8, Y16 16 (1600x1200, Format 7 mode 0) 32 (640x480, Format 7 mode 0) 29 (800x600, Format7 mode 1, 2x2 binning) 29 (1600x600, Format7 mode 2, 1x2 binning)	
Lens Mount	C Mount	
Scanning System	Progressive System	
Binning	2x2, 1x2	
Format7	Partial Scan (Unit: 4x4)	
Trigger	Edge	Rising Edge or Falling Edge
	Mode	0, 1, 2, 3, 4, 5, 14,15
	Source	External Trigger or Software Trigger
Strobe	Active High, Support Normal Mode or Trigger Mode.	
Multi-camera auto sync	-144 us ~ +144 us at 15,7.5 frame rate	
Memory Save/Load	16 Channels(0:factory, 1~4:feature, 5~15:mode/feature)	
One-shot/Multi-shot	65535 Shots	
Control Functions	Brightness, Sharpness, Gamma, Auto-Exposure, Shutter, Gain, Pan/Tilt, High speed up trigger frame rate	
SIO(RS-232)	IIDC v1.31 version : Path through or custom command	
Frame Delay from Read-out	Min. 106us	
Digital Interface / Transfer Rate	IEEE 1394 1 port(6pin) / 400Mbps	
Gain	0 ~ 27 dB (Manual or Auto)	
Shutter Speed	1 usec ~ 3600 sec (Manual or Auto)	
Data Depth	12 bit	
S/N Ratio	56dB or better	
Supply Voltage & Power	Less than 2 Watts (@12V DC)	
External Dimension / Weight	29(W) x 29(H) x 39(D) mm / Approx 63g	
Operation Temp.	-5°C to 45°C	

Remark: Camera Specification described above may be changed without notice

2.1.2. Fire-i 630b Specification

Features		
Image Sensor Type	1/3-inch Interline CCD (Sony ICX204AL)	
Effective pixels	800,000 pixels 1034(H) x 779(V)	
Picture Size	1024x768, 800x600, 640x480, 320x240	
Cell Size(um)	4.65x4.65	
Real Frame Rate	30, 15, 7.5, 3.75, 1.875 / Y8, Y16 36 (1024x768, Format 7 mode 0) 58 (1024x384, Format7 mode2, 1x2 binning) 58 (512x384, Format7 mode1, 2x2 binning)	
Lens Mount	C Mount	
Scanning System	Progressive System	
Binning	Not supported	
Format7	Partial Scan (Unit: 4x4)	
Trigger	Edge	Rising Edge or Falling Edge
	Mode	0, 1, 2, 3, 4, 5, 14, 15
	Source	External Trigger or Software Trigger
Strobe	Active High, Support Normal Mode or Trigger Mode.	
Multi-camera auto sync	-144 us ~ +144 us at 30,15,7.5 frame rate	
Memory Save/Load	16 Channels(0:factory, 1~4:feature, 5~15:mode/feature)	
One-shot/Multi-shot	65535 Shots	
Control Functions	Brightness, Sharpness, Gamma, Auto-Exposure, Shutter, Gain, Pan/Tilt, High speed up trigger frame rate	
SIO(RS-232)	IIDC v1.31 version : Path through or custom command	
Frame Delay from Read-out	Min. 70us	
Digital Interface / Transfer Rate	IEEE 1394 1 port(6pin) / 400Mbps	
Gain	0 ~ 27 dB (Manual or Auto)	
Shutter Speed	1 usec ~ 3600 sec (Manual or Auto)	
Data Depth	12 bit	
S/N Ratio	56dB or better	
Supply Voltage & Power	Less than 2 Watts (@ 12 V DC)	
External Dimension / Weight	29(W) x 29(H) x 39(D) mm / Approx 63g	
Operation Temp.	-5°C to 45°C	

Remark: Camera Specification described above may be changed without notice

2.1.3. Fire-i 530b Specification

Features		
Image Sensor	1/3-inch Interline CCD (Sony ICX424AL)	
Effective Pixels	330,000 pixels 659(H) x 494(V)	
Picture Size	640 x 480, 320 x 240	
Cell Size	7.40 x 7.40	
Real Frame Rate	60, 30, 15, 7.5, 3.75, 1.875 / Y8, Y16 86 (640x480, Format 7 mode 0) 120 (640x240, Format7 mode2, 1x2 binning) 120 (320x240, Format7 mode1, 2x2 binning)	
Lens Mount	C-mount	
Scanning System	Progressive System	
Binning	Not supported	
Format 7	Partial Scan (Unit: 4x4)	
Trigger	Edge	Rising Edge or Falling Edge
	Mode	0, 1, 2, 3, 4, 5, 14, 15
	Source	External Trigger or Software Trigger
Strobe	Active High, Support Normal Mode or Trigger Mode.	
Multi-camera auto sync	-144 us ~ +144 us at 60,30,15,7.5 frame rate	
Memory Save/Load	16 Channels(0:factory, 1~4:feature, 5~15:mode/feature)	
One-shot/Multi-shot	65535 Shots	
Control Functions	Brightness, Sharpness, Gamma, Auto-Exposure, Shutter, Gain, Pan/Tilt, High speed up trigger frame rate	
SIO(RS-232)	IIDC v1.31 version : Path through or custom command	
Frame Delay from Read-out	Min. 43us	
Digital Interface / Transfer Rate	IEEE 1394 1 port(6pin) / 400Mbps	
Gain	0 ~ 27 dB (Manual or Auto)	
Shutter Speed	1 usec ~ 3600 sec (Manual or Auto)	
Data Depth	12 bit	
S/N Ratio	56dB or better	
Supply Voltage & Power	Less than 2 Watts (@ 12 V DC)	
External Dimension / Weight	29(W) x 29(H) x 39(D) mm / Approx 63g	
Operation Temp.	-5°C to 45°C	

Remark: Camera Specification described above may be changed without notice

2.1.4. Fire-i 550b Specification

Features		
Image Sensor	1/3-inch MT9V022177ATM (Micron CMOS)	
Effective Pixels	360,960 pixels 752 (H) x 480(V)	
Picture Size	752 x 480, 640 x 480, 376 x 240	
Cell Size	6 x 6	
Real Frame Rate	60, 30, 15, 7.5, 3.75, 1.875 / Y8, Y16 60 (752x480, Format 7 mode 0) 110 (376x240, Format7 mode1, 2x2 binning)	
Lens Mount	C-mount	
Scanning System	Progressive System	
Binning	2 x 2	
Format 7	Partial Scan (Unit: 4x4)	
Trigger	Edge	Rising Edge or Falling Edge
	Mode	0
	Source	External Trigger or Software Trigger
Strobe	Active High, Support Normal Mode or Trigger Mode.	
Multi-camera auto sync	Not supported	
Memory Save/Load	16 Channels(0:factory, 1~4:feature, 5~15:mode/feature)	
One-shot/Multi-shot	Not supported	
Control Functions	Brightness, Sharpness, Gamma, Auto-Exposure, Shutter, Gain, Pan/Tilt	
SIO(RS-232)	IIDC v1.31 version : Path through or custom command	
Frame Delay from Read-out	Min. 70us	
Digital Interface / Transfer Rate	IEEE 1394 1 port(6pin) / 400Mbps	
Gain	0 ~ 18 dB (Manual or Auto)	
Shutter Speed	93 usec ~ 100 msec (Manual or Auto)	
Data Depth	10 bit	
S/N Ratio	45dB or better	
Supply Voltage & Power	Less than 2 Watts (@ 12 V DC)	
External Dimension / Weight	29(W) x 29(H) x 39(D) mm / Approx 63g	
Operation Temp.	-5°C to 45°C	

Remark: Camera Specification described above may be changed without notice

2.2. Color Cameras

2.2.1. Fire-i 830c Specification

Features		
Image Sensor Type	1/1.8-inch Interline CCD (Sony ICX-274AQ)	
Effective pixels	2,010,000 pixels 1600(H) x 1200(V)	
Picture Size	1600x1200, 1280x960, 1024x768, 800x600, 640x480	
Cell Size(um)	4.4 x 4.4	
Real Frame Rate	15, 7.5, 3.75, 1.875 / Y8, Y16, YUV422 16 (1600x1200, Format 7 mode 0) 32 (640x480, Format 7 mode 0) 29 (800x600, Format7 mode 1, 2x2 binning) 29 (1600x600, Format7 mode 2, 1x2 binning)	
Lens Mount	C Mount	
Scanning System	Progressive System	
Binning	2x2, 1x2	
Format7	Partial Scan (Unit: 4x4)	
Trigger	Edge	Rising Edge or Falling Edge
	Mode	0, 1, 2, 3, 4, 5, 14,15
	Source	External Trigger or Software Trigger
Strobe	Active High, Support Normal Mode or Trigger Mode.	
Multi-camera auto sync	-144 us ~ +144 us at 15,7.5 frame rate	
Memory Save/Load	16 Channels(0:factory, 1~4:feature, 5~15:mode/feature)	
One-shot/Multi-shot	65535 Shots	
Control Functions	Brightness, Sharpness, Gamma, Auto-Exposure, Shutter, Gain, Pan/Tilt, High speed up trigger frame rate, AWB	
SIO(RS-232)	IIDC v1.31 version : Path through or custom command	
Frame Delay from Read-out	Min. 106us	
Digital Interface / Transfer Rate	IEEE 1394 1 port(6pin) / 400Mbps	
Gain	0 ~ 25 dB (Manual or Auto)	
Shutter Speed	1 usec ~ 3600 sec (Manual or Auto)	
Data Depth	12 bit	
S/N Ratio	56dB or better	
Supply Voltage & Power	Less than 2Watts(@12V DC)	
External Dimension / Weight	29(W) x 29(H) x 39(D) mm / Approx 63g	
Operation Temp.	-5°C to 45°C	

Remark: Camera Specification described above may be changed without notice

2.2.2. Fire-i 630c Specification

Features		
Image Sensor Type	1/3-inch Interline CCD (Sony ICX-204AK)	
Effective pixels	800,000 pixels 1034(H) x 779(V)	
Picture Size	1024x768, 800x600, 640x480, 320x240	
Cell Size(um)	4.65 x 4.65	
Real Frame Rate	30, 15, 7.5, 3.75, 1.875 / Y8, Y16, YUV422 36 (1024x768, Format 7 mode 0)	
Lens Mount	C Mount	
Scanning System	Progressive System	
Binning	Not supported	
Format7	Partial Scan (Unit: 4x4)	
Trigger	Edge	Rising Edge or Falling Edge
	Mode	0, 1, 2, 3, 4, 5, 14, 15
	Source	External Trigger or Software Trigger
Strobe	Active High, Support Normal Mode or Trigger Mode.	
Multi-camera auto sync	-144 us ~ +144 us at 30,15,7.5 frame rate	
Memory Save/Load	16 Channels(0:factory, 1~4:feature, 5~15:mode/feature)	
One-shot/Multi-shot	65535 Shots	
Control Functions	Brightness, Sharpness, Gamma, Auto-Exposure, Shutter, Gain, Pan/Tilt, High speed up trigger frame rate, AWB	
SIO(RS-232)	IIDC v1.31 version : Path through or custom command	
Frame Delay from Read-out	Min. 70us	
Digital Interface / Transfer Rate	IEEE 1394 1 port(6pin) / 400Mbps	
Gain	0 ~ 25 dB (Manual or Auto)	
Shutter Speed	1 usec ~ 3600 sec (Manual or Auto)	
Data Depth	12 bit	
S/N Ratio	56dB or better	
Supply Voltage & Power	Less than 2Watts(@12V DC)	
External Dimension / Weight	29(W) x 29(H) x 39(D) mm / Approx 63g	
Operation Temp.	-5°C to 45°C	

Remark: Camera Specification described above may be changed without notice

2.2.3. Fire-i 530c Specification

Features		
Image Sensor Type	1/3-inch Interline CCD (ICX-424AQ)	
Effective pixels	330,000 pixels 659(H) x 494(V)	
Picture Size	640 x 480, 320 x 240	
Cell Size(um)	7.40 x 7.40	
Real Frame Rate	60, 30, 15, 7.5, 3.75, 1.875 / Y8, Y16, YUV422 86 (640x480, Format 7 mode 0)	
Lens Mount	C Mount	
Scanning System	Progressive System	
Binning	Not supported	
Format7	Partial Scan (Unit: 4x4)	
Trigger	Edge	Rising Edge or Falling Edge
	Mode	0, 1, 2, 3, 4, 5, 14, 15
	Source	External Trigger or Software Trigger
Strobe	Active High, Support Normal Mode or Trigger Mode.	
Multi-camera auto sync	-144 us ~ +144 us at 60,30,15,7.5 frame rate	
Memory Save/Load	16 Channels(0:factory, 1~4:feature, 5~15:mode/feature)	
One-shot/Multi-shot	65535 Shots	
Control Functions	Brightness, Sharpness, Gamma, Auto-Exposure, Shutter, Gain, Pan/Tilt, High speed up trigger frame rate, AWB	
SIO(RS-232)	IIDC v1.31 version : Path through or custom command	
Frame Delay from Read-out	Min. 43us	
Digital Interface / Transfer Rate	IEEE 1394 1 port(6pin) / 400Mbps	
Gain	0 ~ 25 dB (Manual or Auto)	
Shutter Speed	1 usec ~ 3600 sec (Manual or Auto)	
Data Depth	12 bit	
S/N Ratio	56dB or better	
Supply Voltage & Power	Less than 2Watts(@12V DC)	
External Dimension / Weight	29(W) x 29(H) x 39(D) mm / Approx 63g	
Operation Temp.	-5°C to 45°C	

Remark: Camera Specification described above may be changed without notice

2.2.4. Fire-i 850c Specification

Features		
Image Sensor Type	1/2-inch MT9T031 (Micron CMOS)	
Effective pixels	3,145,728 pixels 2048(H) x 1536(V)	
Picture Size	2048x1536, 1600x1200, 1280x960, 1024x768, 800x600, 640 x 480	
Cell Size(um)	3.2 x 3.2	
Real Frame Rate	60, 30, 15, 7.5, 3.75 / Y8, Y16, YUV422 10 (2048x1536, Format 7 mode 0) 26 (1024x768, Format 7 mode 1, 2x2 binning)	
Lens Mount	C Mount	
Scanning System	Progressive System	
Binning	2x2	
Format7	Partial Scan (Unit: 4x4)	
Trigger	Edge	Rising Edge or Falling Edge
	Mode	0
	Source	External Trigger or Software Trigger
Strobe	Active High, Support Normal Mode or Trigger Mode.	
Multi-camera auto sync	Not supported	
Memory Save/Load	16 Channels(0:factory, 1~4:feature, 5~15:mode/feature)	
One-shot/Multi-shot	Not supported	
Control Functions	Brightness, Sharpness, Gamma, Auto-Exposure, Shutter, Gain, Pan/Tilt, High speed up trigger frame rate, AWB	
SIO(RS-232)	IIDC v1.31 version : Path through or custom command	
Frame Delay from Read-out	Min. 43us	
Digital Interface / Transfer Rate	IEEE 1394 1 port(6pin) / 400Mbps	
Gain	0 ~ 63 dB (Manual or Auto)	
Shutter Speed	63 usec ~ 1 sec (Manual or Auto)	
Data Depth	10 bit	
S/N Ratio	43dB or better	
Supply Voltage & Power	Less than 2Watts(@12V DC)	
External Dimension / Weight	29(W) x 29(H) x 39(D) mm / Approx 63g	
Operation Temp.	-5°C to 45°C	

Remark: Camera Specification described above may be changed without notice

2.2.5. Fire-i 550c Specification

Features		
Image Sensor Type	1/3-inch MT9V022177ATC (Micron CMOS)	
Effective pixels	360,960 pixels 752(H) x 480(V)	
Picture Size	752 x 480, 752 x 476, 640 x 480	
Cell Size(um)	6.0 x 6.0	
Real Frame Rate	60, 30, 15, 7.5, 3.75 / Y8, Y16, YUV422 60 (752x480, Format 7 mode 0) 60 (752x476, Format 7 mode 2, YUV422)	
Lens Mount	C Mount	
Scanning System	Progressive System	
Binning	Not supported	
Format7	Partial Scan (Unit: 4x4)	
Trigger	Edge	Rising Edge or Falling Edge
	Mode	0
	Source	External Trigger or Software Trigger
Strobe	Active High, Support Normal Mode or Trigger Mode.	
Multi-camera auto sync	Not supported	
Memory Save/Load	16 Channels(0:factory, 1~4:feature, 5~15:mode/feature)	
One-shot/Multi-shot	Not supported	
Control Functions	Brightness, Sharpness, Gamma, Auto-Exposure, Shutter, Gain, Pan/Tilt, High speed up trigger frame rate, AWB	
SIO(RS-232)	IIDC v1.31 version : Path through or custom command	
Frame Delay from Read-out	Min. 70us	
Digital Interface / Transfer Rate	IEEE 1394 1 port(6pin) / 400Mbps	
Gain	0 ~ 12 dB (Manual or Auto)	
Shutter Speed	93 usec ~ 100 msec (Manual or Auto)	
Data Depth	10 bit	
S/N Ratio	45dB or better	
Supply Voltage & Power	Less than 2Watts(@12V DC)	
External Dimension / Weight	29(W) x 29(H) x 39(D) mm / Approx 63g	
Operation Temp.	-5°C to 45°C	

Remark: Camera Specification described above may be changed without notice

2.3. Spectral Sensitivity

Excludes lens and light source characteristics.

2.3.1. B&W Cameras

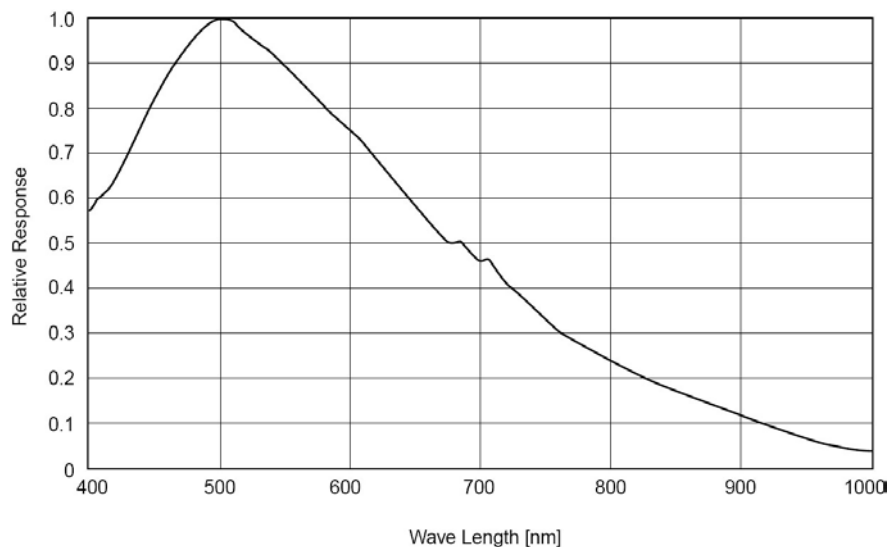

Spectral Sensitivity for Fire-i 830b

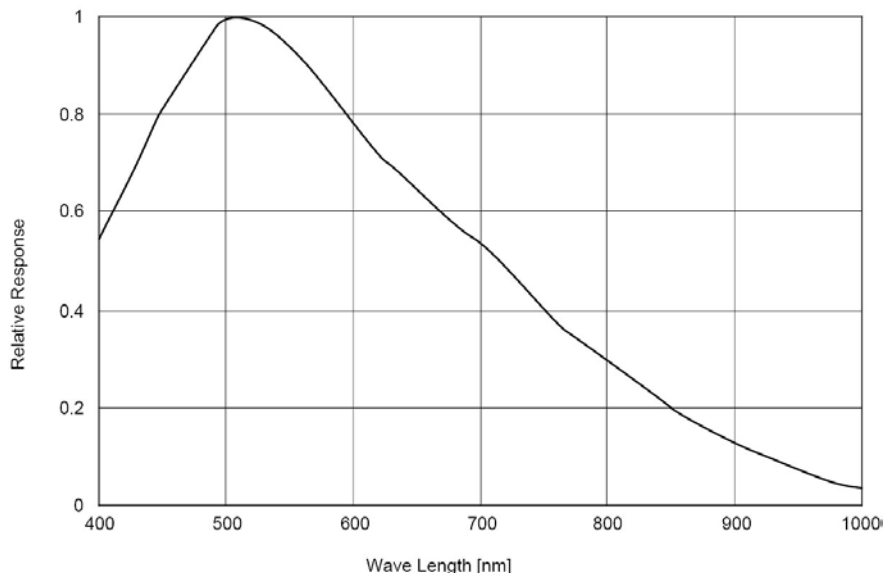

Spectral Sensitivity for Fire-i 630b

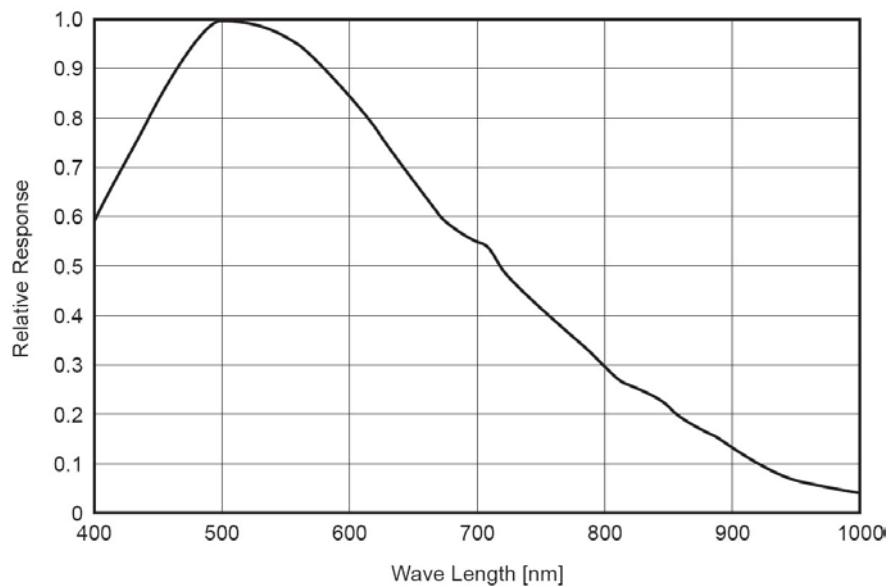

Spectral Sensitivity for Fire-i 530b

MT9V022 Quantum Efficiency- Monochrome

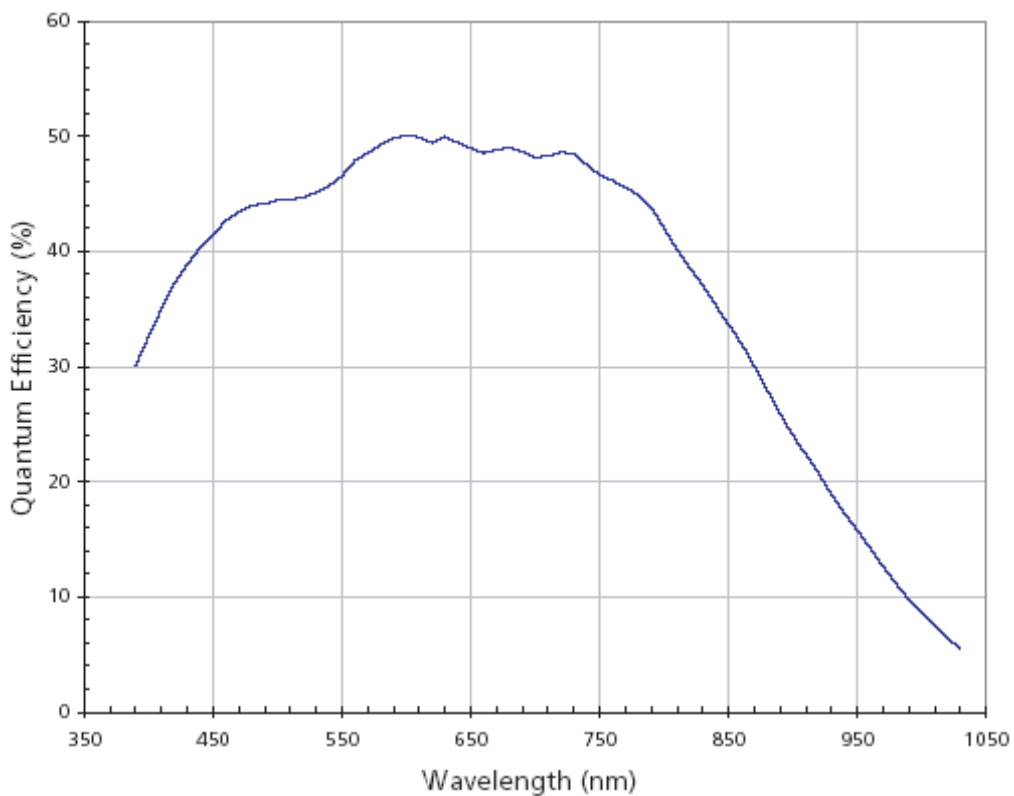

Spectral Sensitivity for Fire-i 550b

2.3.2. Color Cameras

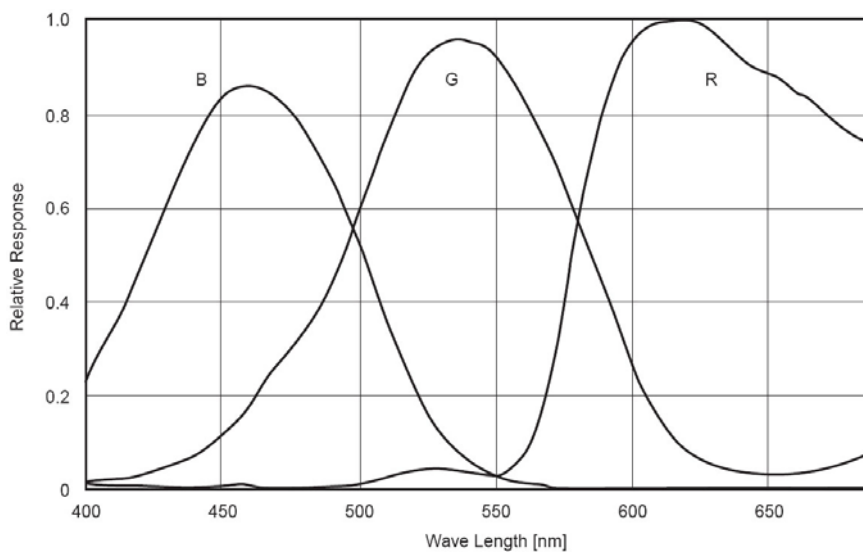

Spectral Sensitivity for Fire-i 830c

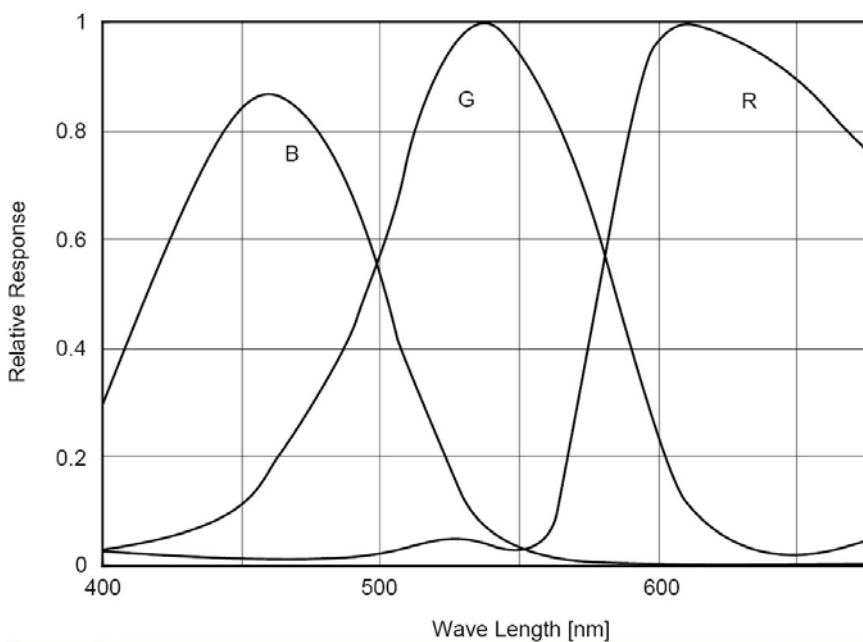

Spectral Sensitivity for Fire-i 630c

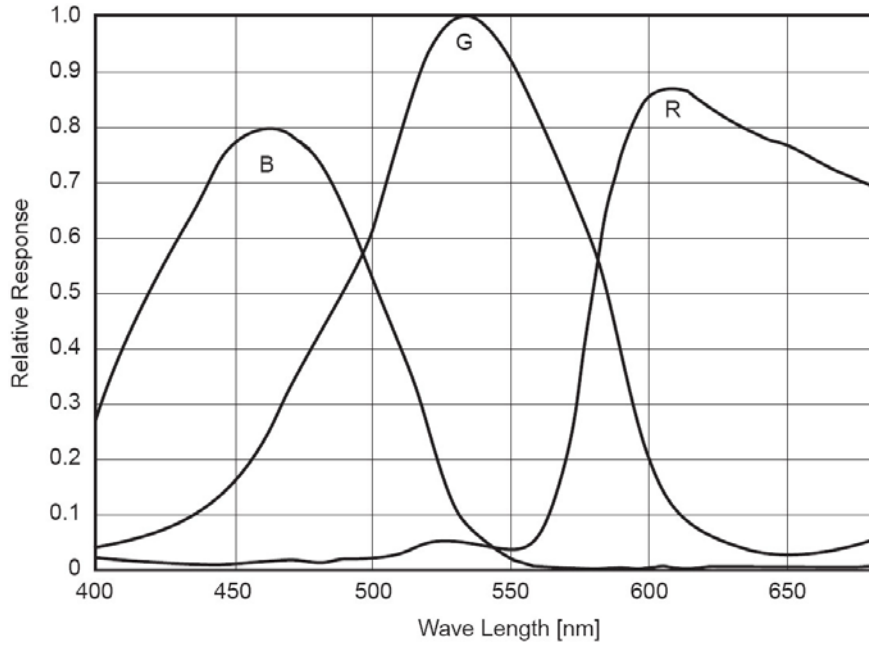

Spectral Sensitivity for Fire-i 530c

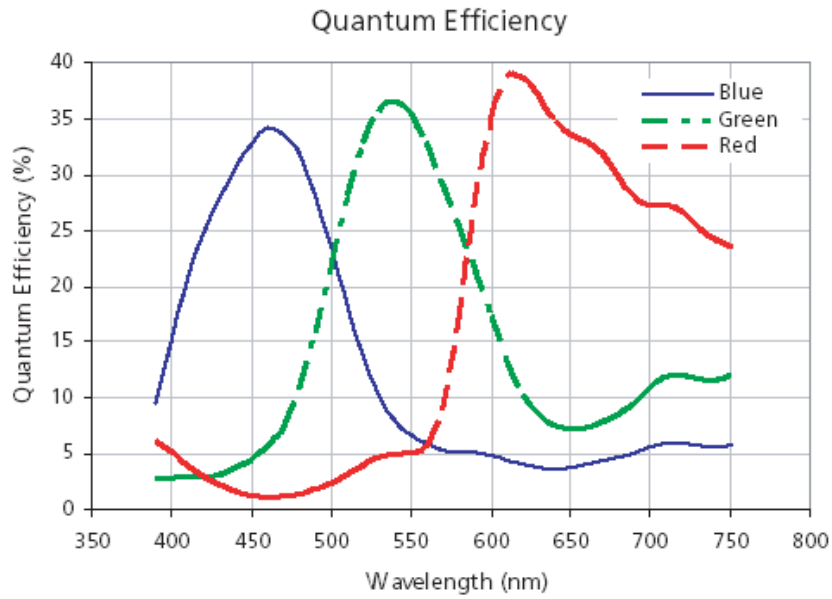

Spectral Sensitivity for Fire-i 850c

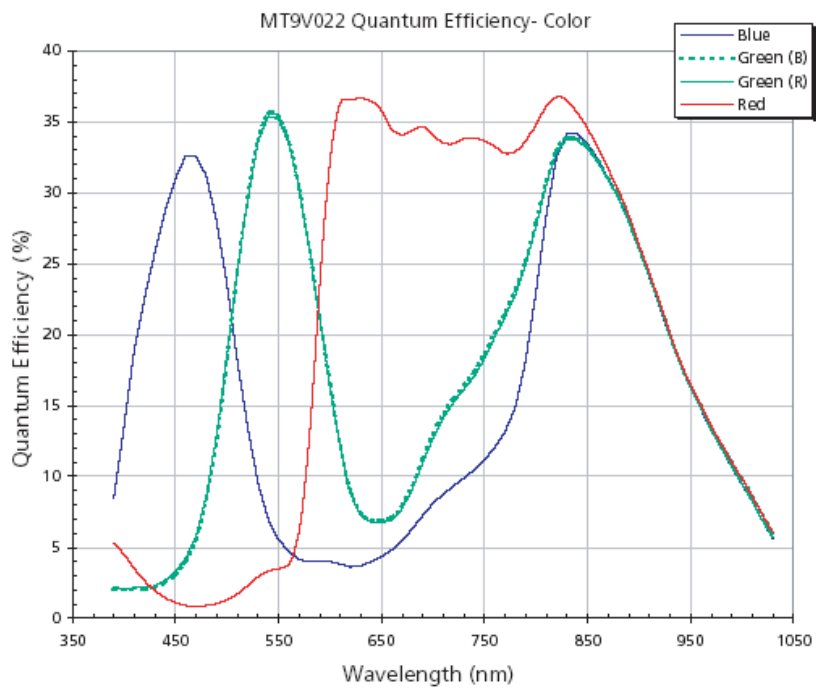

Spectral Sensitivity for Fire-i 550c

3. Basic Operation and Features

The Fire-i x3x cameras employ a progressive scan CCD sensor which provides different features for each model. Basic functions and features are similar, while each camera has its own specific function support. The cameras fully support the IIDC V1.31 specification with regards to registers, video format, mode of operation and control. The Fire-i x5x cameras employ a CMOS sensor.

3.1. Brightness

Brightness of the camera can be controlled by changing the black level in the camera. The user can determine the setting of the camera and control them using the status control register. Adjust the brightness if the appropriate gradation cannot be obtained due to blurring of black portions of the image. The parameters of Brightness are changed inside the camera. For brightness, the parameters are shifted by the black level.

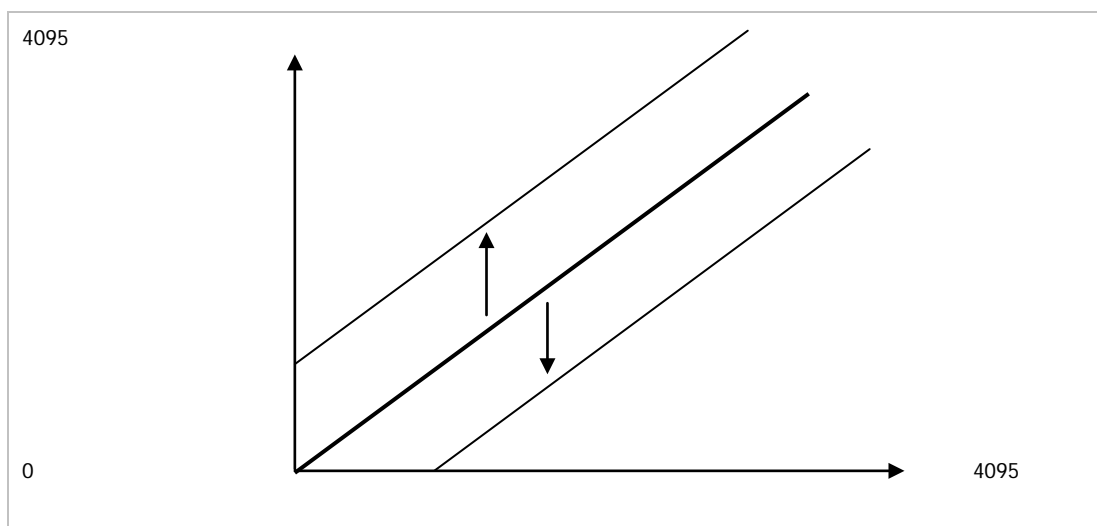

Inquiry Register

Address	Name	Field	Bit	Description
500h	BRIGHTN ESS_INQ	Presence_Inq	[0]	Presence of this feature
		Abs_Control_Inq	[1]	Capability of control with absolute value
		-	[2]	Reserved
		One_Push_Inq	[3]	One push auto mode (Controlled automatically by camera only once)
		ReadOut_Inq	[4]	Capability of reading the value of this feature
		On/OFF_Inq	[5]	Capability of switching this feature ON and OFF
		Auto_Inq	[6]	Auto Mode (Controlled automatically by camera)
		Manual_Inq	[7]	Manual Mode (Controlled by user)
		Min_Value	[8..19]	Minimum value for this feature control
Max_Value	[20..31]	Maximum value for this feature control		

Status Control Register

Address	Name	Field	Bit	Description
800h	BRIGHTNESS	Presence_Inq	[0]	Presence of this feature 0:N/A 1:Available

	Abs_Control	[1]	Absolute value control 0: Control with value in Value field 1: Control with value in Absolute value CSR if this bit =1, value in Value field is ignored
	-	[2..4]	Reserved
	One_Push	[5]	Write '1': begin to work(Self cleared after operation) Read : Value='1' in operation Value ='0' not in operation If A_M_Mode=1, this bit is ignored
	On/OFF	[6]	Write : ON or OFF this feature Read : read a status 0: OFF, 1:ON If this bit=0, other fields will be read only.
	A_M_Mode	[7]	Write : Set the mode Read : Read a current mode 0: Manual, 1:Auto
	-	[8..19]	Reserved
	Value	[20..31]	Minimum value for this feature control

3.2. Auto Exposure Control

The automatic shutter/gain mode is based on a feedback loop which calculates the average pixel luminance. Then the average is compared with the exposure reference value, adjusting shutter and gain accordingly. This feature is similar to "Contrast Control".

Inquiry Register

Address	Name	Field	Bit	Description
504h	AUTO_EXP OSURE_INQ	Presence_Inq	[0]	Presence of this feature
		Abs_Control_Inq	[1]	Capability of control with absolute value
		-	[2]	Reserved
		One_Push_Inq	[3]	One push auto mode(Controlled automatically by camera only once)
		ReadOut_Inq	[4]	Capability of reading the value of this feature
		On/Off_Inq	[5]	Capability of switching this feature On and OFF
		Auto_Inq	[6]	Auto mode (Controlled automatically by camera)
		Manual_Inq	[7]	Manual mode(Controlled by user)
		Min_Value	[8..19]	Minimum value for this feature control
		Max_Value	[20..31]	Maximum value for this feature control

Status Control Register

Address	Name	Field	Bit	Description
804h	AUTO_EXP OSURE	Presence_Inq	[0]	Presence of this feature 0:N/A 1:Available
		Abs_Control	[1]	Absolute value control 0: Control with value in the Value field 1: Control with value in the Absolute value CSR If this bit = 1, value in the Value field is ignored.
		-	[2..4]	Reserved
		One_Push	[5]	Write '1' :begin to work (Self cleared after operation) Read: Value='1' in operation Value='0' not in operation If A_M_Mode =1, this bit is ignored

	ON_OFF	[6]	Write: ON or OFF this feature, Read: read a status 0:OFF, 1:ON If this bit=0, other fields will be read only.
	A_M_Mode	[7]	Write: set the mode, Read: read a current mode 0: Manual, 1:Auto
	-	[8..19]	Reserved
	Value	[20..31]	Value : Write the value in Auto mode, this filed is ignored. If "ReadOut" capability is not available, read value Has no meaning

3.3. Sharpness

The sharpness control feature may be used to compensate low-pass effects caused for instance by the special color interpolation. If you do not prefer such signal manipulation, you may switch it OFF.

For sharpness control inquiry and status register, follow the same definition as "BRIGHTNESS".

3.4. White Balance

Color models have the white balance feature which can be controlled automatically or manually, U/R(Red/Green) and V/B(Green/Blue) alter the degree to which Red and Blue CCD component pixels are weighed to form composite pixels. In manual mode you can adjust the white balance by altering the Blue(U/V) and Red Value(V/R). In addition, the one push white balance option can be used for a non-interactive calibration.

Inquiry Register

Address	Name	Field	Bit	Description
50Ch	WHITE_BAL _INQ	Presence_Inq	[0]	Presence of this feature
		Abs_Control_Inq	[1]	Capability of control with absolute value
		-	[2]	Reserved
		One_Push_Inq	[3]	One push auto mode(Controlled automatically by camera only once)
		ReadOut_Inq	[4]	Capability of reading the value of this feature
		On/Off_Inq	[5]	Capability of switching this feature On and OFF
		Auto_Inq	[6]	Auto mode(Controlled automatically by camera)
		Manual_Inq	[7]	Manual mode(Controlled by user)
		Min_Value	[8..19]	Minimum value for this feature control
		Max_Value	[20..31]	Maximum value for this feature control

Status Control Register

Address	Name	Field	Bit	Description
80Ch	WHITE_BALANCE	Presence_Inq	[0]	Presence of this feature. 0:N/A 1:Available
		Abs_Control	[1]	Absolute value control 0: Control with value in the Value field 1: Control with value in the Absolute value CSR If this bit = 1, value in the Value field is ignored.
		-	[2..4]	Reserved
		One_Push	[5]	Write '1' :begin to work(Self cleared after operation) Read: Value='1' in operation Value='0' not in operation If A_M_Mode =1, this bit is ignored
		ON_OFF	[6]	Write: ON or OFF this feature, Read: read a status 0:OFF, 1:ON If this bit=0, other fields will be read only.
		A_M_Mode	[7]	Write: set the mode, Read: read a current mode 0: Manual, 1:Auto
		-	[8..19]	U Value / B_Value. Write the value in AUTO mode, this field is ignored. If "ReadOut" capability is not available,, read value has no mean
		Value	[20..31]	V Value / R_Value Write the value in AUTO mode, this field is ignored. If "ReadOut" capability is not available, read value has no meaning

3.5. Hue

Color models support Hue control which changes the color phase of the picture by adjusting the Green gain. You may use this feature when white balance correction adjusting Red and Blue value does not give satisfying result.

3.6. Gamma

Gamma control defines the function between incoming light level and output picture level. The Factory default setting for Gamma is set to 1.0. Gamma value is adjustable in the range of 0.4 ~ 2.5 as per the table below. For Gamma control inquiry and status register, follow the same definition as "BRIGHTNESS".

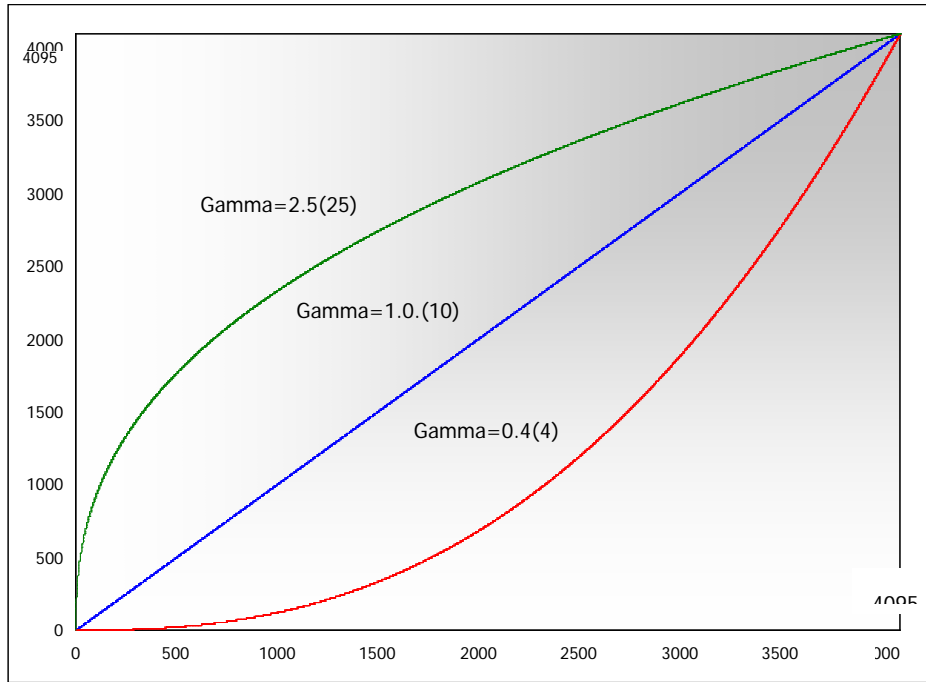

Gamma Range Table

Gamma Value	4	5	6	7	8	9	10	11	12	13	14
Gamma	0.4	0.5	0.6	0.7	0.8	0.9	1.0	1.1	1.2	1.3	1.4

Gamma Value	15	16	17	18	19	20	21	22	23	24	25
Gamma	1.5	1.6	1.7	1.8	1.9	2.0	2.1	2.2	2.3	2.4	2.5

3.7. Shutter

Shutter is defined as the integration time of the incoming light where both the Manual and the Auto Shutter are supported. The shutter range varies from 1us ~ 3600sec. For Shutter control inquiry and status register, follow the same definition as "BRIGHTNESS".

3.7.1.1. Fire-i x3x models (530, 630, 830)

Shutter Speed Value & Range

1394 Shutter Value (Y)	Increment Step	Shutter Speed Time : T	
		Exposure Time	Range
1~500	1us	T= Y us	1us ~ 500us
501~1000	10us	T= (Y-500)*10+500 us	510us ~ 5500us
1001~1705	100us	T= (Y-1000)*100+5500 us	5.6ms ~ 76ms

1706 ~ 2399	1ms	$T = (Y-1705) + 76 \text{ ms}$	77ms ~ 770ms
2400~2902	10ms	$T = (Y-2399) * 10 + 770 \text{ ms}$	780ms ~ 5800ms
2903~3304	100ms	$T = (Y-2902) * 100 + 5800 \text{ ms}$	5.9s ~ 46s
3305~3508	1s	$T = (Y-3304) * 1000 + 46000 \text{ ms}$	47s ~ 250s
3509~3843	10s	$T = (Y-3508) * 10 + 250 \text{ s}$	260s ~ 3600s

Shutter Speed Example

Example Shutter Speed Table					
1394 Shutter	Exposure Time	1394 Shutter	Exposure Time	1394 Shutter	Exposure Time
1	1us	1729	100ms	3378	2 min
10	10us	1829	200ms	3438	3 min
100	100us	2129	500ms	3513	5 min
500	500us	2422	1s	3525	7min
550	1ms	2522	2s	3543	10 min
650	2ms	2822	5s	3603	20 min
950	5ms	2944	10s	3663	30 min
1045	10ms	3044	20s	3723	40 min
1145	20ms	3318	60s	3783	50 min
1445	50ms	3323	65s	3843	60 min

3.7.1.2. Fire-i x5x models (550, 850)

Shutter Speed Value & Range

1394 Shutter Value (Y)	Increment Step	Shutter Speed Time : T	
		Exposure Time	Range
1 ~ 500	1us	$T = Y \text{ us}$	1us ~ 500us
501 ~ 1000	10us	$T = (Y-500) * 10 + 500 \text{ us}$	510us ~ 5500us
1001 ~ 1705	100us	$T = (Y-1000) * 100 + 5500 \text{ us}$	5.6ms ~ 76ms
1706 ~ 2399	1ms	$T = (Y-1705) + 76 \text{ ms}$	77ms ~ 770ms
2400~2422	10ms	$T = (Y-2399) * 10 + 770 \text{ ms}$	780ms ~ 100ms

Shutter Speed Example

Example Shutter Speed Table			
1394 Shutter	Exposure Time	1394 Shutter	Exposure Time
1	1us	1729	100ms
10	10us	1829	200ms
100	100us	2129	500ms
500	500us	2422	1s

3.8. Gain

Gain refers to the amount of the CCD output signal amplification where gain and shutter have similar effect on the image. Manual and Automatic gain mode are supported and manual adjustment is possible for the following range.

For Gain control inquiry and status register, follow the same definition as "BRIGHTNESS".

3.8.1.1. Fire-i x3x models (530, 630, 830)

Camera Type	Step Range	Range in dB	Increment Length
Monochrome Camera	0 ~ 723	0 ~ 27	approx. 0.0345 dB/step
Color Camera	0 ~ 723	0 ~ 25	approx. 0.0319 dB/step
Auto Gain	0 ~ 528	All models except Fire-i 530	
Auto Gain	0 ~ 468	Fire-i 530	

3.8.1.2. Fire-i x5x models (550, 850)

Camera Type	Step Range	Range in dB	Increment Length
Fire-i 550 (b/c)	16 ~ 64	0 ~ 12	(16~31) – 20 x Log(step x 0.0625)
			(32~64) – 20 x Log(step/2 x 0.0625)
Fire-i 850c	0 ~ 63	Digital gain	

3.9. Trigger & Strobe

The cameras support external trigger by receiving input through the external trigger port. The falling edge and rising edge can be detected as a trigger according to the modes it supports as per the following table. Strobe timing is user controllable while signal output is TTL. The cameras can also be used with a software trigger that issues a trigger signal via a software command.

3.9.1. Supported Trigger

3.9.1.1. Fire-i x3x models (530, 630, 830)

Trigger	Edge	Rising Edge or Falling Edge
	Mode	0, 1, 2, 3, 4, 5, 14, 15
	Source	External or Software Trigger

3.9.1.2. Fire-i x5x models (550, 850)

Trigger	Edge	Rising Edge or Falling Edge
	Mode	0
	Source	External or Software Trigger

Inquiry Register

Address	Name	Field	Bit	Description
530h	TRIGGER_I NQ	Presence_Inq	[0]	Presence of this feature
		Abs_Control_Inq	[1]	Capability of control with absolute value
		-	[2..3]	Reserved
		ReadOut_Inq	[4]	Capability of reading the value of this feature
		On/Off_Inq	[5]	Capability of switching this feature On and OFF
		Polarity_Inq	[6]	Capability of changing polarity of trigger input
		-	[7..15]	Reserved
		Trigger_Mode0_Inq	[16]	Presence of Trigger Mode0
		Trigger_Mode1_Inq	[17]	Presence of Trigger Mode1
		Trigger_Mode2_Inq	[18]	Presence of Trigger Mode2
		Trigger_Mode3_Inq	[19]	Presence of Trigger Mode3
-	[20..31]	Reserved		

Status Control Register

Address	Name	Field	Bit	Description
830h	TRIGGER_ MODE	Presence_Inq	0	Presence of this feature 0:N/A 1:Available
		Abs_Control	[1]	Absolute value control 0: Control with value in the Value field 1: Control with value in the Absolute value CSR If this bit = 1, value in the Value field is ignored.
		-	[2..5]	Reserved
		ON_OFF	[6]	Write: ON or OFF this feature Read: read a status 0: OFF, 1: ON If this bit=0, other fields will be read only.
		Trigger_Polarity	[7]	If Polarity_Inq is "1", Write to change polarity of the trigger input Read to get polarity of trigger input If Polarity_Inq is "0", Read only. (0: Low active input, 1: High active input)
		-	[8..11]	Reserved
		Trigger_Mode	[12..15]	Trigger mode.(Trigger_Mode_0-15)
		-	[16..19]	Reserved
-	Parameter	[20..31]	Parameter for trigger function, if required.	

3.9.2. Trigger and Strobe Signal Relation

3.9.2.1. Fire-i 530, 630, 830

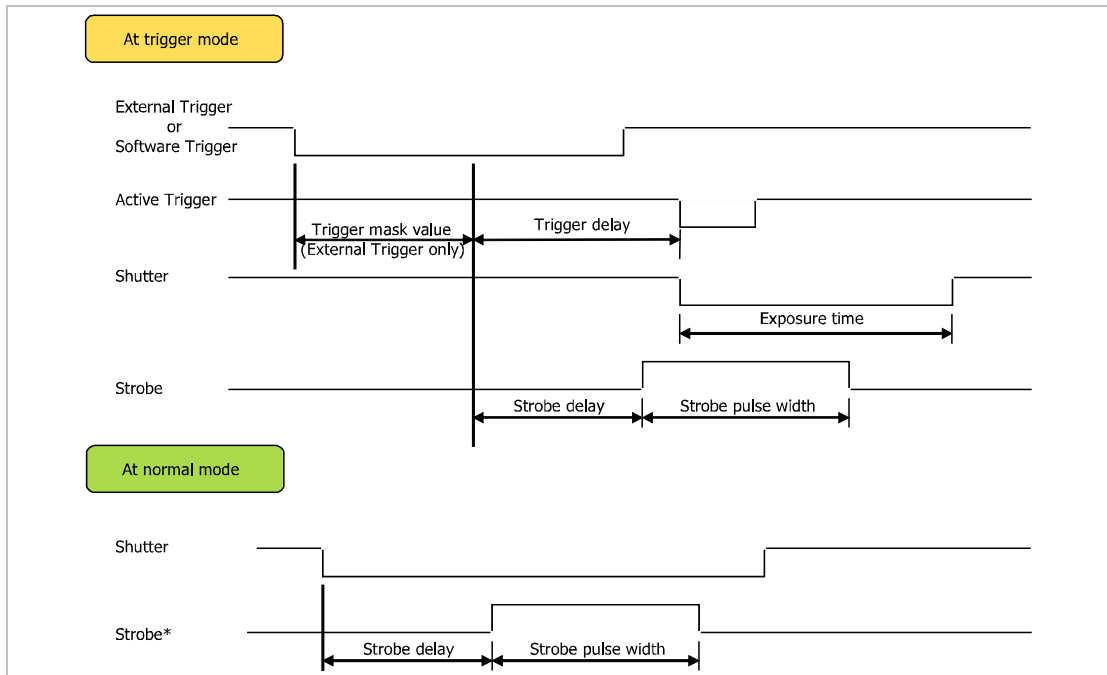

Trigger overlapping function : max trigger frame rate speed up to normal mode frame rate.

Previous version

$$\text{Trigger max frame rate} = \frac{1}{1/\text{fps} + \text{shutter_time}(0x000081c) + \text{trigger_delay}(0x0000834) + \text{trigger_noise_filter}(0x2f10110)}$$

Version 3.10

At trigger mode 0 :

$$\text{Trigger max frame rate} = \frac{1}{1/\text{fps} + \text{trigger_delay}(0x0000834) + \text{trigger_noise_filter}(0x2f10110) + 200 \text{ usec}}$$

If trigger delay = 0 and trigger noise filter is disabled, trigger max frame rate speeds up to frame rate at normal mode

Caution:

If the next trigger pulse interval is less than $(1/\text{fps} + \text{trigger_delay}(0x0000834) + \text{trigger_noise_filter}(0x2f10110) + 200 \text{ usec})$, this trigger pulse may be lost.

At other trigger mode : equal to the previous frame rate.

$$\text{Trigger max frame rate} = \frac{1}{1/\text{fps} + \text{shutter_time}(0x000081c) + \text{trigger_delay}(0x0000834) + \text{trigger_noise_filter}(0x2f10110)}$$

If trigger interval is less than $(1/\text{fps} + \text{shutter_time})$, bar noise may be detected.

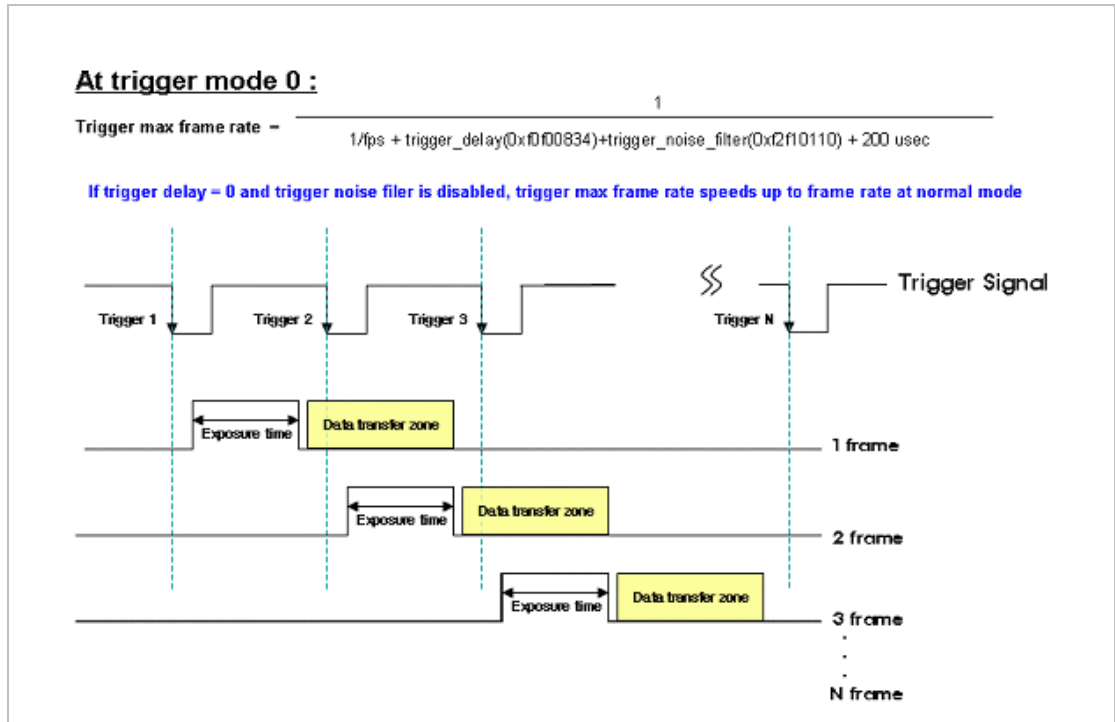

3.9.2.2. Fire-i 550, 850

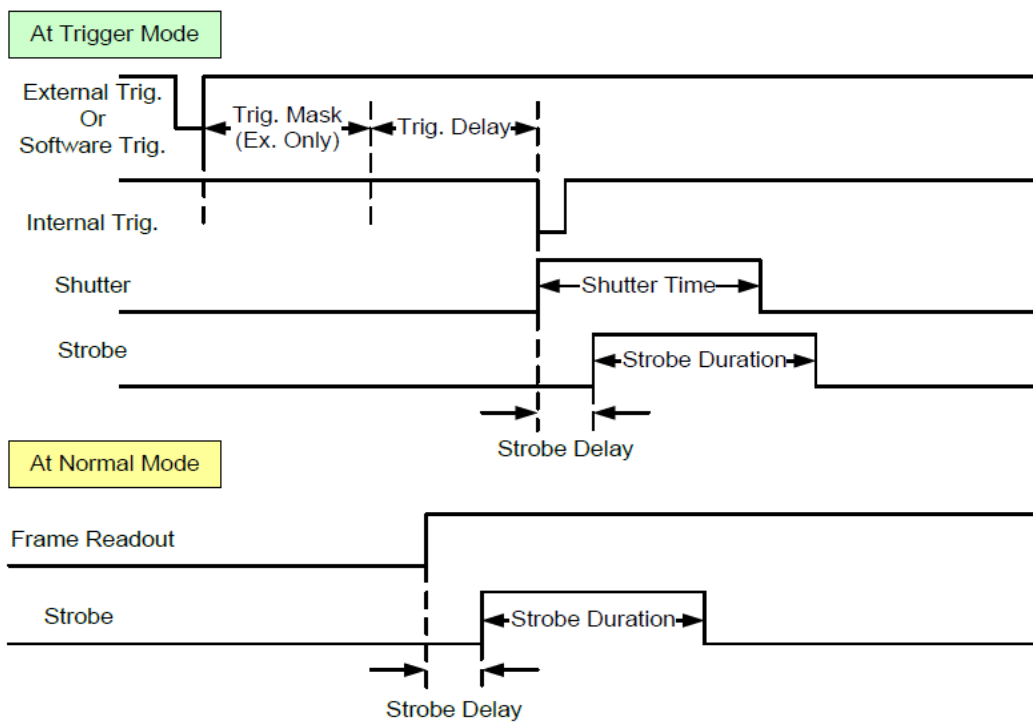

3.9.2.3. Trigger Timing Diagram for Fire-i 550, 850

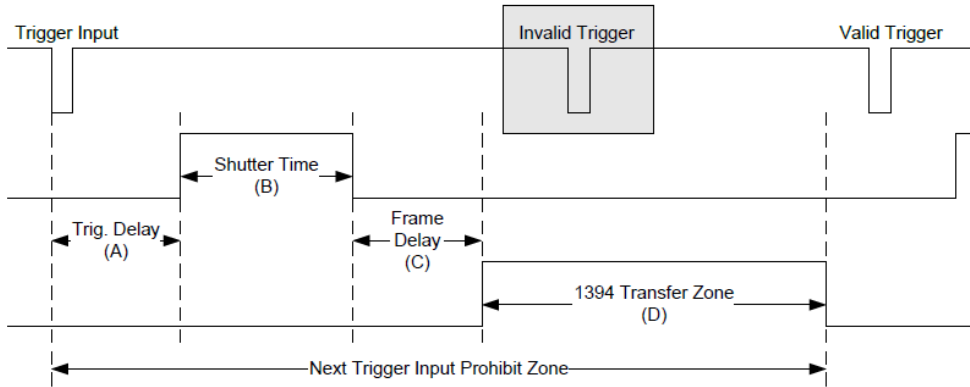

Correlation of VD and fps

Cameras	A	B	C	D (Y8)		
Fire-i 530b Fire-i 530c	Trigger Mask + Trigger delay+ 350ns	Exposure Time	7HD	640 x 480	60fps	1VD
					30fps	2VD
					15fps	4VD
					7.5fps	8VD
					3.75fps	16VD
				752 x 480	Format 7	1VD
Fire-i 850	Trigger Mask + Trigger delay+ 250ns	Exposure Time	29 HD	640 x 480	60fps	1VD
					30fps	2VD
					15fps	4VD
					7.5fps	8VD
					3.75fps	16VD
				800 x 600	30fps	1 VD
					15fps	2 VD
					7.5fps	4 VD
					3.75fps	8 VD
					1024 x 768	15fps
1280 x 960	7.5fps	2 VD				
1600 x 1200	3.75fps	4 VD				
2048 x 1536	Format 7	1VD				

3.9.2.4. Timing Diagram for External Trigger and Shutter and Strobe

Fire-i 530, 630, 830

This diagram shows the necessary time related to each signal for External trigger and Shutter and Strobe.

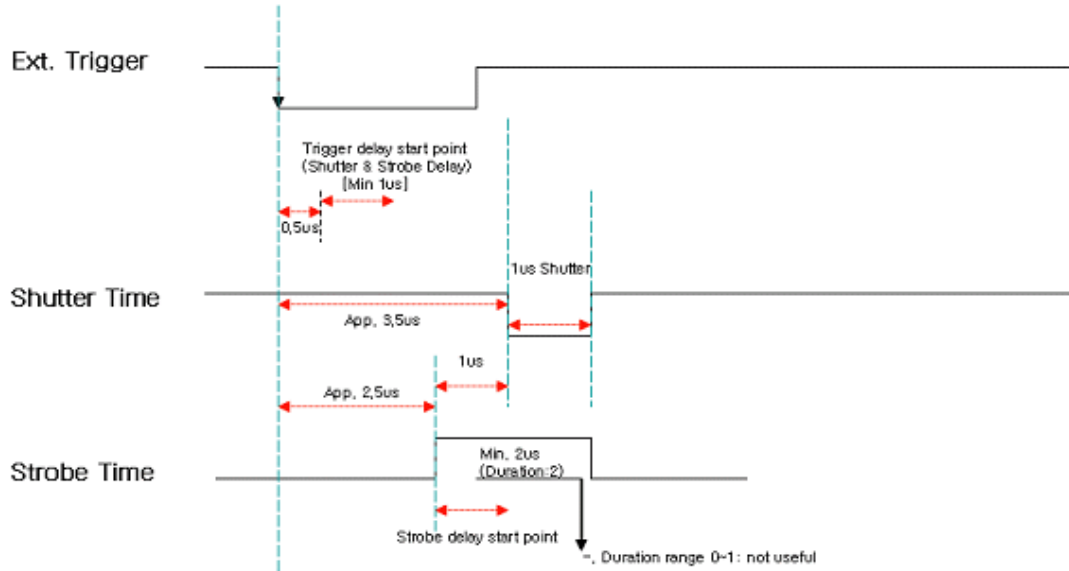

3.9.3. Trigger and Strobe delay

The starting point for the Strobe signal is the same as the Starting point for the External trigger

Fire-i 530, 550, 630, 830, 850

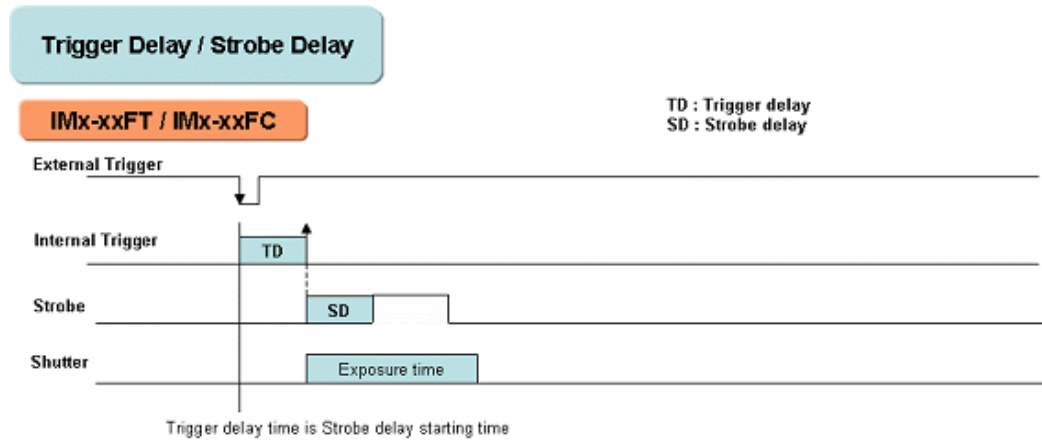

3.9.4. Trigger Mode 0

The Camera starts integration of the incoming light from the external trigger input falling edge. The Integration time is described in the "Shutter" register. No parameter is needed.

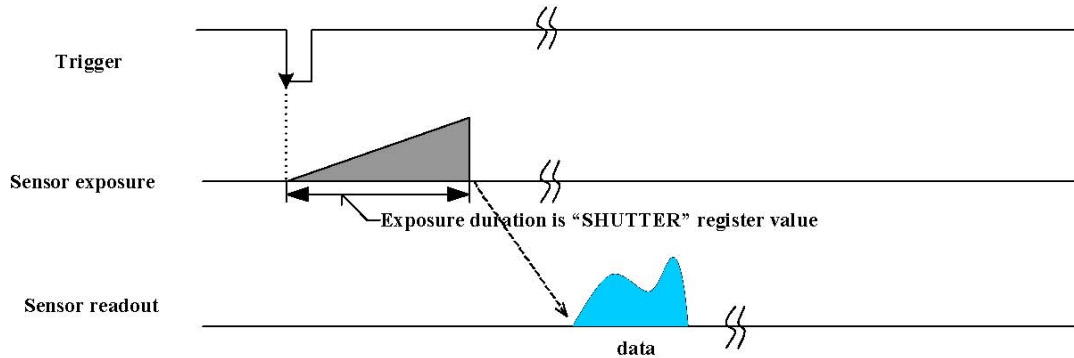

3.9.5. Trigger Mode 1

The camera starts the integration of the incoming light from the external trigger input falling edge. The integration time is equal to the low state time of the external trigger input. No parameter is needed.

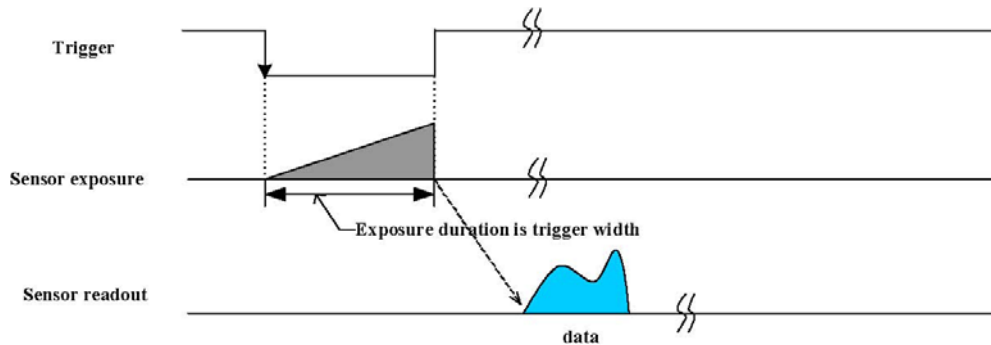

3.9.6. Trigger Mode 2

The camera starts the integration of incoming light from the first external trigger input falling edge. At the N-th (parameter) external trigger input falling edge, the integration will be stopped. A parameter is required and shall be two or more. ($N \geq 2$).

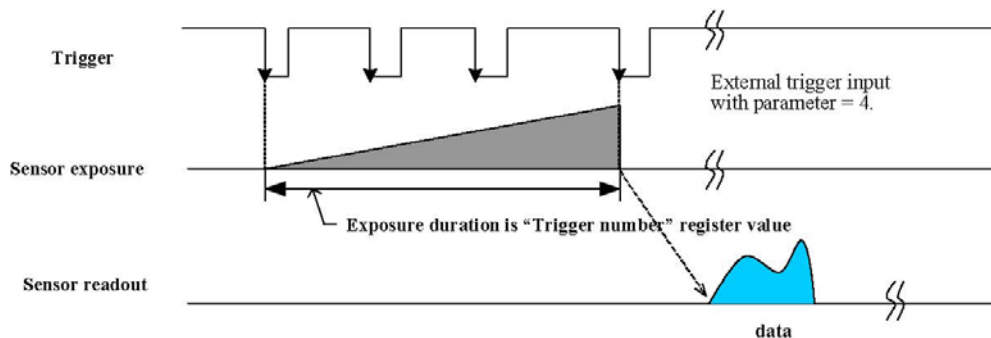

3.9.7. Trigger Mode 3

Not supported at Format 7 Mode

This is an internal trigger mode. The camera will issue a trigger internally and the cycle time is N times (parameter) the cycle time of the fastest frame rate. The Integration time of the incoming light is described in the "Shutter" register. A Parameter is required and shall be one or more ($N \geq 1$).

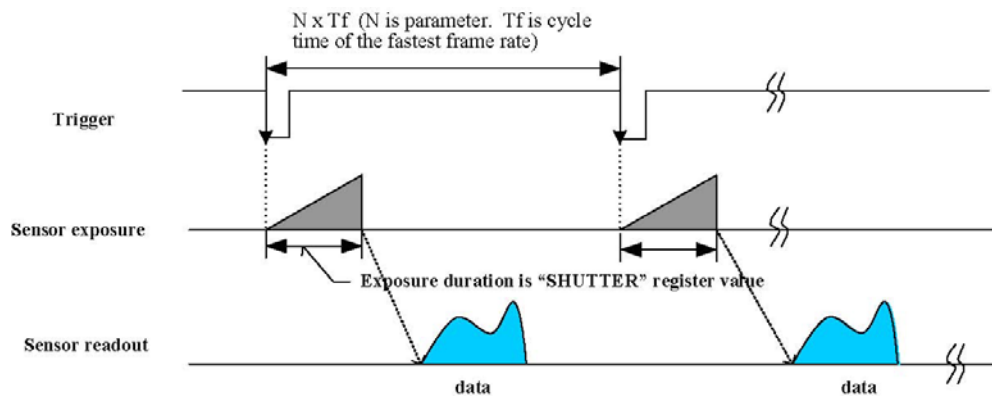

3.9.8. Trigger Mode 4

This mode is the "multiple shutter preset mode". The camera starts the integration of the incoming light from the first external trigger input falling edge and exposes the incoming light at shutter time. Repeat this sequence for the N -th (parameter) external trigger input falling edge and then finish integration. A parameter is required and shall be one or more. ($N \geq 1$).

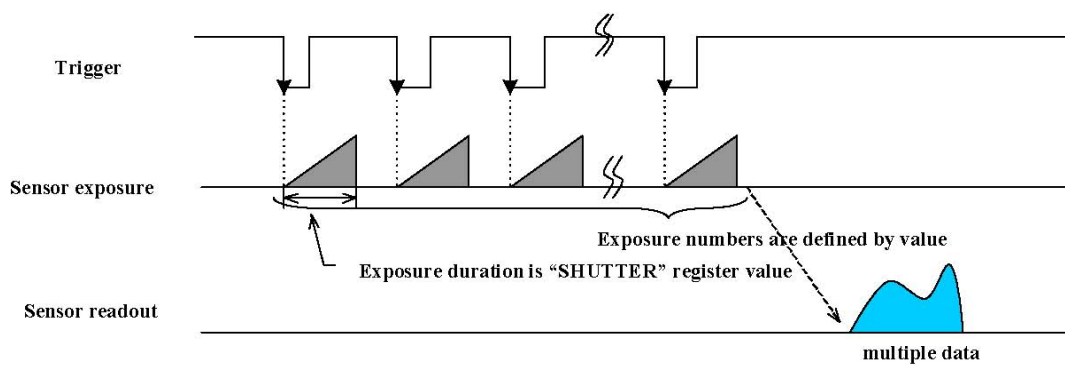

3.9.9. Trigger Mode 5

This mode is the “multiple shutter pulse width mode”. The camera starts the integration of the incoming light from the first external trigger input falling edge and exposes the incoming light until the trigger is inactive. Repeat this sequence for the N-th (parameter) external trigger input falling edge and then finish integration. A parameter is required and shall be one or more. ($N \geq 1$)

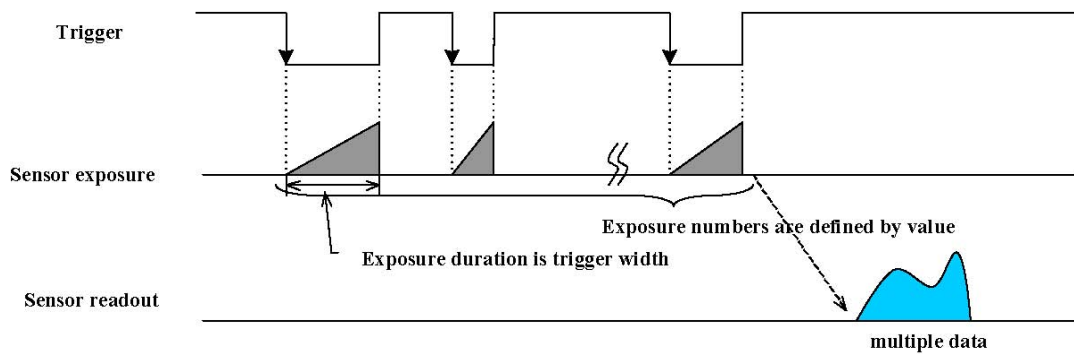

3.9.10. Trigger Mode 14

This mode is the “preset multiple shutter mode with a single trigger”.

This mode is similar to “trigger mode 4” but the difference is that all the parameters are preset by the users using only a single trigger. “Exposure Number”, “Exposure Duration”, and “Exposure Interval” are the parameters required for this mode. However, the exposure duration and interval in each multiple shutter is equal and cannot be different. Exposure duration & interval is defined by a user defined 1394 address (0xF2F10114)

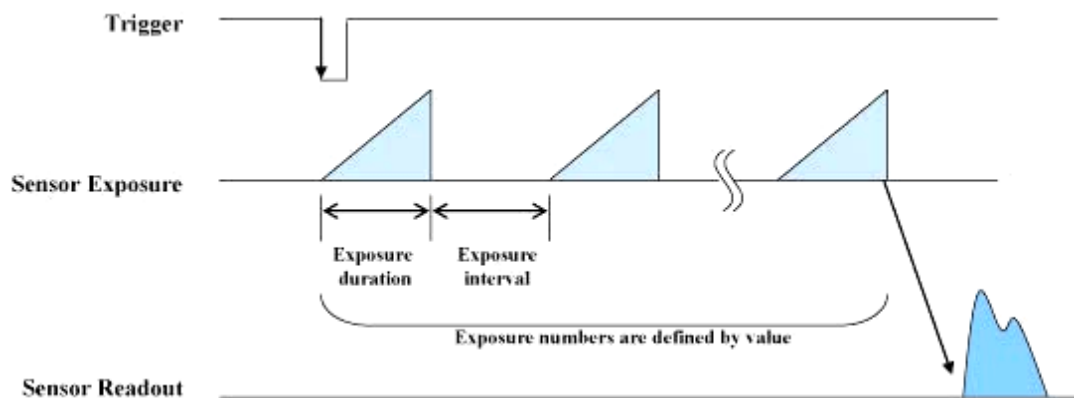

3.9.11. Trigger Mode 15

Trigger mode 15 is the new function. The user can capture as many images as they want with one external trigger signal. This mode is called ‘One-trigger Multi-frames’. For this mode 15, the value of the shutter time should be fixed. The mode 15 is supported by both H/W trigger and S/W trigger.

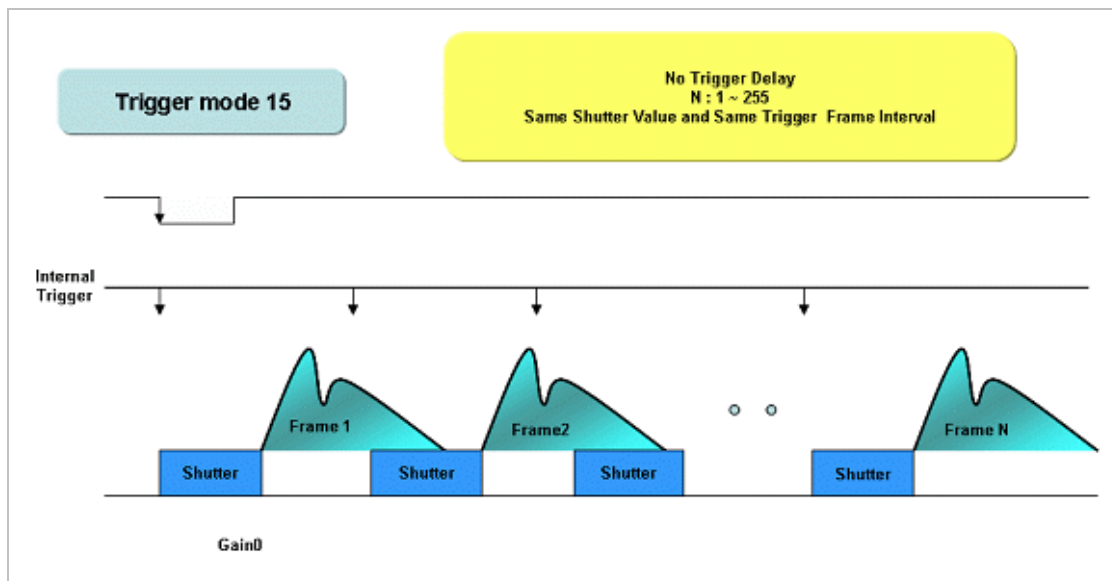

				active output, 1: High active output)
		Delay_Value	[8..19]	Delay after start of exposure until the strobe signal asserts
		Duration_Value	[20..31]	Duration of the strobe signal A value 0 means dessert at the end of exposure function if required.
204h	Strobe_1_Cnt	Same definition to Strobe_0_Inq		
208h	Strobe_2_Cnt	Same definition to Strobe_1_Inq		
20Ch	Strobe_3_Cnt	Same definition to Strobe_2_Inq		
210h : 2FFh	Reserved			

3.11. Trigger Delay Control

Based on the external triggers, the user can delay image acquisition by the trigger delay control feature.

Trigger Delay Table

Mode	Value range	Trigger delay Time : T	
		DelayTime	Range
All Cameras	0 ~ 4000	T = Yusc	0 usec ~ 4000 usec

Inquiry Register

Address	Name	Field	Bit	Description
534h	TRIGGER_DLY_INQ	Presence_Inq	[0]	Presence of this feature
		Abs_Control_Inq	[1]	Capability of control with absolute value
		-	[2]	Reserved
		One_Push_Inq	[3]	One push auto mode (Controlled automatically by camera only once)
		ReadOut_Inq	[4]	Capability of reading the value of this feature
		On/OFF_Inq	[5]	Capability of switching this feature ON and OFF
		Auto_Inq	[6]	Auto Mode (Controlled automatically by camera)
		Manual_Inq	[7]	Manual Mode (Controlled by user)
		Min_Value	[8..19]	Minimum value for this feature control
		Max_Value	[20..31]	Maximum value for this feature control

Status Control Register

Address	Name	Field	Bit	Description
834h	TRIGGER_DELAY	Presence_Inq	[0]	Presence of this feature 0:N/A 1:Available
		Abs_Control	[1]	Absolute value control 0: Control with value in Value field 1: Control with value in Absolute value CSR if this bit =1, value in Value filed is ignored
		-	[2..5]	Reserved
		On/OFF	[6]	Write : ON or OFF this feature Read : read a status 0: OFF, 1: ON If this bit=0, other fields will be read only.
		-	[7..19]	Reserved
		Value	[20..31]	Minimum value for this feature control

The table shows the strobe index by the increment step through strobe delay time and strobe duration time. Increment Step is different according to strobe index.

Strobe Delay/Duration Table				
Strobe Index(Y)	Increment Step	Strobe Delay Time : T		
		Delay Time	Duration Time	Range
0		0us	N.A	
1		1us	N.A	
2		2us	2us	
3~250	1us	T=Y us	T=Y us	3us~250us
251~489	250us	$T=(Y-250)*250us+250us$	$T=(Y-250)*250us+250us$	500us~60ms
Strobe Delay/Duration Index				
Strobe Delay/Duration Index	Strobe Delay Time		Strobe Duration Time	
0	0us		N.A	
1	1us		N.A	
2	2us		2us	
10	10us		10us	
100	100us		100us	
250	250us		250us	
253	1ms		1ms	
257	2ms		2ms	
269	5ms		5ms	
289	10ms		10ms	
329	20ms		20ms	
449	50ms		50ms	
489	60ms		60ms	

3.12. Optical Filter Control

The Optical Filter control allows the user to change the optical filter of the camera. You can change the Bayer pattern by moving the starting position of the pattern by one position up, down, right or left. (Only for color models)

Inquiry Register

Address	Name	Field	Bit	Description
58Ch	OPTICAL_FILTER_I NQ	Presence_Inq	[0]	Presence of this feature
		Abs_Control_Inq	[1]	Capability of control with absolute value
		-	[2]	Reserved
		One_Push_Inq	[3]	One push auto mode (Controlled automatically by camera only once)
		ReadOut_Inq	[4]	Capability of reading the value of this feature
		On/OFF_Inq	[5]	Capability of switching this feature ON and OFF
		Auto_Inq	[6]	Auto Mode (Controlled automatically by camera)
		Manual_Inq	[7]	Manual Mode (Controlled by user)
		Min_Value	[8..19]	Minimum value for this feature control
		Max_Value	[20..31]	Maximum value for this feature control

Status Control Register

Address	Name	Field	Bit	Description
88Ch	OPTICAL_FILTER	Presence_Inq	[0]	Presence of this feature 0:N/A 1:Available
		Abs_Control	[1]	Absolute value control 0: Control with value in Value field 1: Control with value in Absolute value CSR if this bit =1, value in Value field is ignored
		-	[2..5]	Reserved
		On/OFF	[6]	Write : ON or OFF this feature Read : read a status 0: OFF, 1:ON If this bit=0, other fields will be read only.
		-	[7..19]	Reserved
		Value	[20..31]	Minimum value for this feature control

3.13. Color (Bayer) Patterns Conversion

Color sensors capture images through an optical low pass filter placed over the individual pixels in a Bayer mosaic layout. The Imaged data is transferred to the PC where the color processing can save bandwidth gaining higher frame rate and flexibility of applying different Bayer Patterns on the PC side.

Obtained Images can be processed in any of the following 4 different conversion algorithms on the PC side.

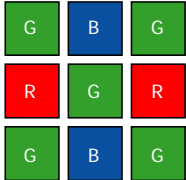
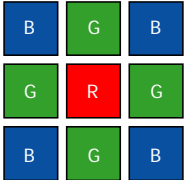
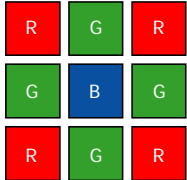
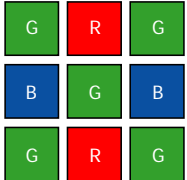
Modes	Mode 0 GB/RG	Mode 1 BG/GR	Mode 2 RG/GB	Mode 3 GR/BG
Color(Bayer) Pattern				

4. Advanced Features

4.1. Binning Mode

Binning is defined as reading neighboring pixels from the CCD and combining them to create one pixel value. Binning has an advantage in the following situations as well as in various applications. Relative binning mode per camera model is described in each camera specification.

- Low Light Operation: Combining neighboring pixels increases the area of the unit pixel receiving light and may obtain a brighter picture in low light conditions with a possible noise reduction.
- High Frame Rate Operation: Vertical Binning accelerates the speed of the CCD data transfer rate by combining multiple vertical lines per single horizontal line of the CCD; resulting in a significant gain in frame rate.

4.1.1. Vertical Binning

Vertical binning combines neighboring CCD pixels vertically into a single pixel; increasing the light sensitivity of the camera. Since a CCD acquires data horizontally, multiple lines are acquired in the case of vertical binning which results in a significant speed gain. Thus the vertical resolution is reduced. Due to the increased CCD area per pixel, over exposure may occur which may require adjustment.

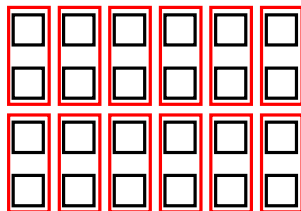

1x2 Vertical Binning

Example

4.1.2. Horizontal Binning

Horizontal binning combines neighboring CCD pixels horizontally into a single pixel; increasing the light sensitivity of the camera. However, due to the nature of a CCD transferring each horizontal line at a time, there is no speed gain in horizontal binning. Light sensitivity increase may occur, due to the increased CCD area per pixel, similar to vertical binning. The horizontal resolution is reduced

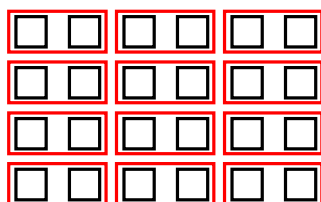

2x1 Horizontal Binning

Example

4.1.3. Full Binning

Full binning mode can be obtained by combining both vertical and horizontal binning. First horizontal pixels are combined; followed by a vertical conjunction of these pixels. This would increase light sensitivity by a factor of 4 in the case of 2 x 2 (Horizontal x Vertical) binning. However as described above, only vertical binning would result in a speed gain while horizontal binning gives no speed gain. Thus, the speed gain result is similar to vertical binning. Resolution in this mode would be reduced both horizontally and vertically.

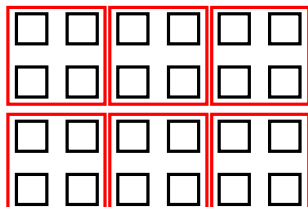

2x2 Full Binning
Example

4.2. Partial Scan

Cameras provide a certain resolution which is dictated by the image sensor. Often, a certain region may be of interest to the user. Partial scan mode provides the function to capture a certain region of interest (ROI) which can provide an advantage in data transfer speed, resulting in a faster operation. As described in binning mode, the speed gain would occur only if vertical resolution decreases. Partial Scan is only supported in Format 7 by setting the following registers described in the IIDC1.31 specification. Unit size of the partial scan is described in the camera specification, which the user must consider in setting the increment configuration.

IMAGE POSITION & IMAGE SIZE register

$$\text{Left} = \text{Hposunit} * n1$$

$$\text{Top} = \text{Vposunit} * m1$$

$$\text{Width} = \text{Hunit} * n2$$

$$\text{Height} = \text{Vunit} * m2$$

$$\text{Left} + \text{Width} < = \text{Hmax}$$

$$\text{Top} + \text{Height} < = \text{Vmax}$$

(n1,n2, m1, m2 are integer)

0 - 7	8 - 15	16 - 23	24 - 31
Left		Top	
0 - 7	8 - 15	16 - 23	24 - 31
Width		Height	

Initial Values	System Dependant
Read Values	Last Update Value
Write Effect	Stored

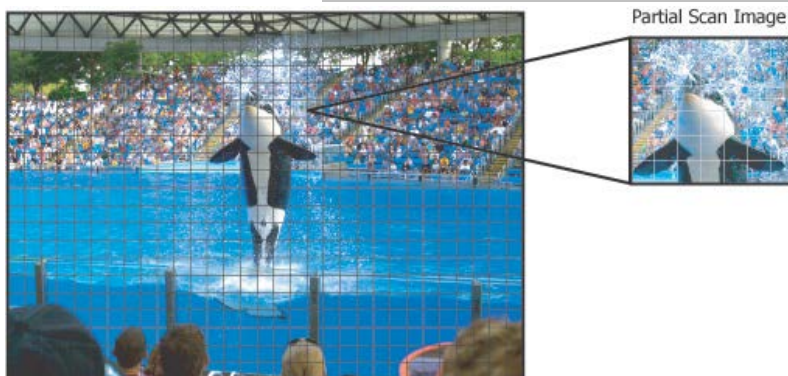

4.3. Pan/Tilt

Pan/Tilt is a function used to move a camera up and down or left and right. However, unlike the mechanical Pan/Tilt which is carried out by physically moving the camera up and down, this function by using a smaller video mode than the CCD's effective pixels and moving the image up and down. This results in a reduced resolution, which the user can specify by the Pan/Tilt command. Pan/Tilt range and values depend on the characteristic of each CCD used in the camera respectively as per the following tables. Note that at Format 7 mode, the pan/tilt value must be set at non-format 7 mode before operation.

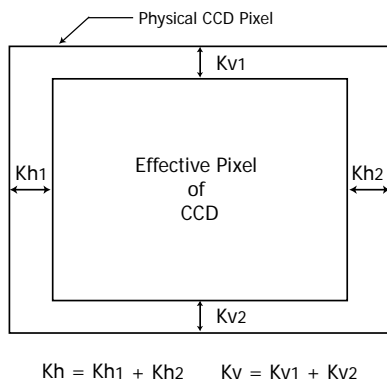

Pan/Tilt Details for Fire-i 530b & Fire-i 530c

Image Size	Movement	Fire-i 530b Kh =12, Kv=12		Fire-i 530c Kh=8, Kv=10	
		Range(Incr.=1)	Default	Range(Incr.=2)	Default
320 x 240	Pan	160 ~ 492	326	160 ~ 488	324
	Tilt	120 ~ 372	246	120 ~ 370	242
640 x 480	Pan	320 ~ 332	326	320 ~ 328	324
	Tilt	240 ~ 252	246	240 ~ 250	242

*At format7 mode, PAN/TITL value must be set at non-format7 mode.

Pan/Tilt Details for Fire-i 630b & Fire-i 630c

Image Size	Movement	Fire-i 630b Kh=8, Kv=8		Fire-i 630c Kh=8, Kv=8	
		Range(Incr.=1)	Default	Range(Incr.=2)	Default
320 x 240	Pan	160 ~ 872	516	160 ~ 872	516
	Tilt	120 ~ 656	388	120 ~ 656	388
640 x 480	Pan	320 ~ 712	516	320 ~ 712	516
	Tilt	240 ~ 536	388	240 ~ 536	388
800 x 600	Pan	400~632	516	400~632	516
	Tilt	300~476	388	300~476	388
1024 x 768	Pan	400 ~ 632	516	400 ~ 632	516
	Tilt	300 ~ 476	388	300 ~ 476	388

*At format7 mode, PAN/TITL value must be set at non-format7 mode

Pan/Tilt Details for Fire-i 830b & Fire-i 830c

Image Size	Movement	Fire-i 830b		Fire-i 830c	
		Kh=22, Kv=34		Kh=20, Kv=34	
		Range(Incr.=1)	Default	Range(Incr.=2)	Default
320 x 240	Pan	160 ~ 1462	810	160 ~ 1460	810
	Tilt	120 ~ 1114	616	120 ~ 1114	616
640 x 480	Pan	320 ~ 1302	810	320 ~ 1300	810
	Tilt	240 ~ 994	616	240 ~ 994	616
800 x 600	Pan	400 ~ 1222	810	400 ~ 1220	810
	Tilt	300 ~ 934	616	300 ~ 934	616
1024 x 768	Pan	512 ~ 1110	810	512 ~ 1108	810
	Tilt	384 ~ 850	616	384 ~ 850	616
1280 x 960	Pan	640 ~ 982	810	640 ~ 980	810
	Tilt	480 ~ 754	616	480 ~ 754	616
1600 x 1200	Pan	800 ~ 822	810	800 ~ 820	810
	Tilt	600 ~ 634	616	600 ~ 634	616
1600 x 1200 Format 7 Mode 0	Pan				
	Tilt				
800 x 600 Format 7 Mode 1	Pan				
	Tilt				
1600 x 600 Format 7 Mode 2	Pan				
	Tilt				

4.4. One-Shot and Multi-Shot

This camera supports One-Shot and Multi-Shot features. The camera should be in ISO disabled mode before the execution of these commands. If the camera is in ISO enabled mode, these commands are ignored. One-Shot is used to grab only one frame. Multi-Shot is used to grab 1~65,535 frames. One-Shot and Multi-Shot can be used combined with a hardware trigger which grabs either one frame or multi frames according to the respective command. The command can be executed configuring the following registers.

Caution: One-Shot and Multi-Shots are not supported in trigger mode

One-Shot		Multi-Shot	
Address	F0F0061CH	Address	F0F0061CH
Data	80000000h	Data	4000nnnh

nnnn is the number of output frames which can be any number between 0001h ~ FFFFh.(1 ~ 65,535)

Priority of the command execution is as follows. Continuous → One-shot → Multi-shot.

When a command with higher priority is being executed, the command with lower priority will be ignored.

This function is Not supported by Fire-i 550 and Fire-i 850 models.

4.5. Multi-Camera Auto-sync.

Not supported in 3.75 fps

In applications incorporating Multi-Camera, there is often a need to synchronize the cameras. Multi-Camera Auto Synchronization is supported utilizing the FireWire bus time cycle register which is connected on the same FireWire bus without an external signal. Max 3 cameras can be supported for auto-sync on an OHCI card.

The video mode of the camera must be set within the limit of a single FireWire bus bandwidth of 400Mbps. Also, the maximum shutter value must be set as per the table below, not exceeding the FireWire bus cycle time. Jitter may occur due to CPU operation timing. In the auto-sync mode, the shutter time and the fps should be set as follows: (This function is Not supported by Fire-i 550 and Fire-i 850 models)

FPS	Fire-i 530x		Fire-i 630x		Fire-i 830x	
	Max Shutter		Max Shutter		Max Shutter	
	Value	Time	Value	Time	Value	Time
60	1110	16.5ms	-	-	-	-
30	1276	33.1ms	1270	32.5ms	-	-
15	1608	66.3ms	1598	65.3ms	1606	66.1ms
7.5	1760	131ms	1758	129ms	1760	131ms
3.75	1893	264ms	1889	260ms	1893	264ms

To utilize Auto-sync, please set Bit 31 to Auto-sync Enable, and then check the Bit 27 to verify whether it is ready.

Please refer the details as the following table.

0xF2F10018	Auto-Sync Mode control register Bit 31 : auto sync enable Bit 30 : SIO enable mode (0 : Custom mode, 1 : IIDC v1.31) Bit 27 : auto sync complete (read only. 1: ready, 0: not yet auto-sync)	Read/Write
------------	--	------------

4.6. Asynchronous Broadcasting

Asynchronous broadcasting is supported when using node 63 of the FireWire bus as a target node for an asynchronous write request. This enables all the cameras to be triggered by software simultaneously. By utilizing Asynchronous Broadcasting, the user can operate and control all the cameras on the same FireWire bus at the same time, with a single command.

4.7. Memory Channel Save / Load

The setting of the camera features (Shutter, Gain, etc) and video mode can be stored in a non-volatile memory. The camera supports 16 memory channels as per the table below for the user to conveniently save and load different features as well as video modes. Channel 0 is for factory default and Channels 1~4 are for saving features. Channels 5~15 are for resolution, mode and frame rate plus saving other features.

Address	Name	Bit	Description
618h	Memory_Save	[0]	Saves the current setting
		[1..31]	Reserved
Address	Name	Bit	Description
620h	Mem_Save_Ch	[0]	Factory Default Setting Cannot overwrite
		[1..4]	Write Channel for Memory Save for Channel 1 ~ 4 (Only for Features)
		[5..15]	Write Channel for Memory Save for Channel 5 ~ 15 (For Features, Format and Mode Save)
Address	Name	Bit	Description
624h	Cur_Save_Ch	[0]	Read and Load Factory Default Setting
		[1..4]	Read and Load Memory Channel 1 ~ 4
		[5..15]	Read and Load Load Memory Channel 5 ~ 15

User Defined FireWire Register Control

The values saved in the channel are users define; and can be made the default values at power-on. The channels from 1 to 15 are to be set in the power-on default mode.

Address	Description(bit : msb*)	Read/Write
0xF2F1011C	Power on default memory channel Bit 0 ~ Bit 3 : power on initial memory channel	Read/Write

4.8. Time Stamp Register

The Time stamp register may be inquired from the Native FireWire Bus (IEEE-1394.a) CYCLE_TIME registers as follows. You may also get the same value from user defined registers but we recommend this.

Address	Description(bit : msb*)	Read/Write																		
0xF000200	CYCLE_TIME	Read																		
	<table border="1" style="width: 100%; border-collapse: collapse;"> <tr> <td style="width: 33.33%; text-align: center;">0 1 2 3 4 5 6 7 8 9 10 11 12 13 14 15 16 17 18 19</td> <td style="width: 33.33%; text-align: center;">20 21 22 23 24 25 26 27 28 29 30 31</td> </tr> <tr> <td style="text-align: center;">SECONDS COUNT</td> <td style="text-align: center;">CYCLE COUNT</td> </tr> </table>		0 1 2 3 4 5 6 7 8 9 10 11 12 13 14 15 16 17 18 19	20 21 22 23 24 25 26 27 28 29 30 31	SECONDS COUNT	CYCLE COUNT														
	0 1 2 3 4 5 6 7 8 9 10 11 12 13 14 15 16 17 18 19		20 21 22 23 24 25 26 27 28 29 30 31																	
	SECONDS COUNT		CYCLE COUNT																	
	<table border="1" style="width: 100%; border-collapse: collapse;"> <thead> <tr> <th style="width: 15%;">Bit Number</th> <th style="width: 25%;">Bit Name</th> <th style="width: 15%;">Function</th> <th style="width: 5%;">DIR</th> <th style="width: 40%;">Description</th> </tr> </thead> <tbody> <tr> <td style="text-align: center;">0 - 6</td> <td style="text-align: center;">SECONDS COUNT</td> <td style="text-align: center;">Seconds Count</td> <td style="text-align: center;">R/W</td> <td style="text-align: center;">1 Hz cycle timer counter</td> </tr> <tr> <td style="text-align: center;">7 - 19</td> <td style="text-align: center;">CYCLE COUNT</td> <td style="text-align: center;">Cycle Count</td> <td style="text-align: center;">R/W</td> <td style="text-align: center;">8,000 Hz cycle timer counter</td> </tr> <tr> <td style="text-align: center;">20 - 31</td> <td style="text-align: center;">CYCLE OFFSET</td> <td style="text-align: center;">Cycle Offset</td> <td style="text-align: center;">R/W</td> <td style="text-align: center;">24.576 MHz cycle timer counter</td> </tr> </tbody> </table>		Bit Number	Bit Name	Function	DIR	Description	0 - 6	SECONDS COUNT	Seconds Count	R/W	1 Hz cycle timer counter	7 - 19	CYCLE COUNT	Cycle Count	R/W	8,000 Hz cycle timer counter	20 - 31	CYCLE OFFSET	Cycle Offset
Bit Number	Bit Name	Function	DIR	Description																
0 - 6	SECONDS COUNT	Seconds Count	R/W	1 Hz cycle timer counter																
7 - 19	CYCLE COUNT	Cycle Count	R/W	8,000 Hz cycle timer counter																
20 - 31	CYCLE OFFSET	Cycle Offset	R/W	24.576 MHz cycle timer counter																

4.9. Serial Interface

The cameras are equipped with the SIO (Serial input/output) feature described in the IIDC 1.31 specification. By using the serial interface, the user can execute commands by writing data in a specific address in the FireWire address range. SIO can be further used as an RS232 interface which supports pass through and custom commands.

4.9.1. SIO Pass Through Scheme

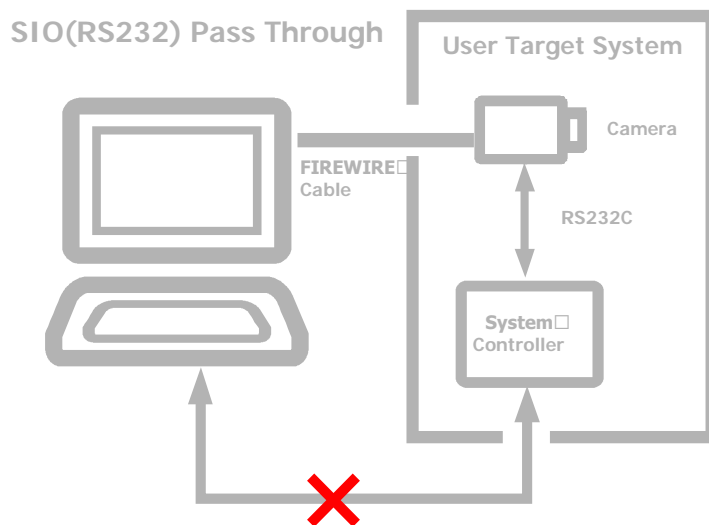

SIO (RS232) Control Setting Procedure

STEP 1. Configuration of Registers Address : F2F22000h

Baud Rate : 9600, No Parity, 1 bit Stop, 8 bit data length

Write : F2F22000h, Data = 050800000h

Value read after write = 050800020h 20 is the buffer of TX and RX

STEP 2. Enable RS232 TX / RX Address : F2F22004h

Write Data : C0000000 : Now RS232 TX / RX port is enabled

SIO (RS232) RX Control Procedure

STEP 1 Read RBUF_ST of the Receive Buffer Status Control Register (address : F2F22008h) and check number of RX data buffered in the camera.

If (RBUF_ST !=0) the RX is Ready else RX is NOT Ready

RBUF_ST : The number of current data buffered in the camera (Unit : byte)

RBUF_CNT : READ : Remaining RX buffer size

STEP 2 Write number of RX data intended to read from RBUF_CNT of the Receive Buffer Status Control Register (address : F2F22008h)

RBUF_CNT can be configured by unit of byte.

STEP 3 Read RS232 RX data from SIO_Data_Register (addr. : F2F22100)

STEP 4 If data is further required repeat from STEP1

Note that 1394 data consist of 32 bit data the data read should

Bit 0 ~ Bit 7 : 1st Data Bit 8 ~ Bit 15 : 2nd Data
 Bit 16 ~ Bit 23 : 3rd Data Bit 24 ~ Bit 31 : 4th Data
 Bit 0 : Msb Bit 31 : Lsb

SIO (RS232) TX Control Procedure Method I

STEP 1 Check TX buffer size by reading TBUF_ST of the Transmit_Buffer_Status_Control register(Addr. : F2F220Ch)

If ((TBUF_ST == Buffer_Size_Inq) or (TBUF_TDRD ==1)) then TX is COMPLETE else TX is INCOMPLETE

TBUF_ST : Current TX Data buffer(Unit:byte) of the camera

TBUF_CNT : Read : Number of data transmitted by RS232 TX

Buffer_Size_Inq : Defined in Serial_Mode_Reg(Addr. : F2F22000h)

Ex) 20050000h : valid data buffer size = 20 number of data sent : 05

STEP 2 Write number of RS232 TX data to be set for TBUF_CNT at SIO_Data_Register(Addr: F2F22100h)

STEP 3 Write number of TX data to be transferred to TBUF_CNT of Transmit_Buffer_Status_Control Register(Addr:F2F2200Ch)

TBUF_CNT can be configured by unit of byte.

The value of TBUF_CNT must be smaller than data written at SIO_Data_Register.

If (write data number > = TBUF_CNT)

{

RS232TX Start

Write Data number larger than TBUF_CNT is discarded.

For example if TBUF_CNT = 5 , in IEEE-1394 write is done by a unit of 4 bytes where 8 bytes shall be written at SIO_Data_Register but only 5 bytes are transmitted and the 3 bytes remaining shall be discarded.

}

STEP4 If there is data to be transmitted repeat from Step 1 .

Bit 0 ~ Bit 7: 1st Data Bit 8 ~ Bit 15: 2nd Data
 Bit 16 ~ Bit 23: 3rd Data Bit 24 ~ Bit 31: 4th Data
 Bit 0 : Msb Bit 31 : Lsb

SIO (RS232) TX Control Procedure Method II

STEP 1 Check TX buffer size by reading TBUF_ST of the Transmit_Buffer_Status_Control register(Addr. : F2F220Ch)

If ((TBUF_ST == Buffer_Size_Inq) or (TBUF_TDRD ==1)) then TX is COMPLETE else TX is INCOMPLETE

TBUF_ST : Current TX Data buffer(Unit:byte) of the camera

TBUF_CNT : Read : Number of data transmitted by RS232 TX

Buffer_Size_Inq : Defined in Serial_Mode_Reg(Addr. : F2F22000h)

Ex) 20050000h : valid data buffer size = 20 number of data sent : 05

STEP 2 Write number of RS232 TX data to be set for TBUF_CNT at Transmit_Buffer_Status_Control Register(Addr:F2F2200Ch)

TBUF_CNT can be configured by unit of byte.

The value of TBUF_CNT must be smaller than data written at SIO_Data_Register.

STEP 3 Write RS232 TX data set at TBUF_CNT to SIO_Data Register(Addr. : F2F22100h)

If (write data number > = TBUF_CNT)

{

RS232TX Start

Write Data number larger than TBUF_CNT is discarded.

For example if TBUF_CNT = 5 , in IEEE-1394 write is done by a unit of 4 bytes where 8 bytes shall be written at SIO_Data_Register but only 5 bytes are transmitted and the 3 bytes remaining shall be discarded.

}

STEP4 If there is data to be transmitted repeat from Step 1 .

Bit 0 ~ Bit 7 : 1st Data

Bit 8 ~ Bit 15 : 2nd Data

Bit 16 ~ Bit 23 : 3rd Data

Bit 24 ~ Bit 31 : 4th Data

Bit 0 : Msb Bit 31 : Lsb

4.9.2. SIO(RS232) Registers

Base address: F2F22000h, default baud rate is 57600

Address	Name	Field	Bit	Description
000h	Serial_Mode_Reg	Baud Rate	[0..7]	Baud Rate Setting Write : Set baud rate Read : Get current baud rate 0: 300 bps 1: 600 bps 2: 1200 bps 3: 2400 bps 4: 4800 bps 5: 9600 bps 6: 19200 bps 7: 38400 bps 8: 57600 bps 9: 115200bps 10: 230400bps Other value reserved.
		Char_Length	[8..15]	Character length setting Write: Set data length (must not be 0) Read : Get data length 7: 7 bits 8: 8 bits Other values reserved.
		Parity-	[16..17]	Parity setting Write : Set Parity Read : Get current parity 0: None 1 : Odd 2 : Even
		Stop_bit	[18..19]	Stop bits Write : Set stop bit Read : Get current stop bit 0: 1 1: 1.5 2: 2.
		-	[20..23]	Reserved
		Buffer_Size_Inq	[24..31]	Buffer Size (Read Only) This field indicates the maximum size of receive/transmit data buffer. If this value=1, Buffer_Status_Control, SIO_Data_Register Char1-3 should be ignored
		004h	Serial_Control_Reg	RE
TE	[1]			Transmit enable Read : Current status Write : 0 : Disable 1: Enable
-	[2..7]			Reserved
Serial_Status_Reg	TDRD		[8]	Transmit data buffer ready Read only 0 : Not ready 1: Ready
	-		[9]	Reserved
	RDRD		[10]	Receive data buffer ready Read only 0 : Not ready 1: Ready
	-		[11]	Reserved
	ORER		[12]	Receive buffer over run error Read : Current status Write : 0: Clear flag 1: Ignored
	FER		[13]	Receive data framing error Read : Current status

				Write : 0: Clear flag 1: Ignored
		PER	[14]	Receive data parity error Read : Current status Write : 0: Clear flag 1: Ignored
		-	[15]	Reserved
008h	Receive_Buffer_Status_Control	RBUF_ST	[0..8]	SIO receive buffer status Read : Valid data size of current receive buffer Write : Ignored
		RBUF_CNT	[8..15]	SIO receive buffer control Read : Remain data size for read Write : Set input data size
		-	[16..31]	Reserved
00Ch	Transmit_Buffer_Status_Control	TBUF_ST	[0..7]	SIO output buffer status Read : Available data space of transmit buffer Write : Ignored
		TBUF_CNT	[8..15]	SIO output buffer control Read : Written data size to buffer Write : Set output data size for transmit
		-	[16..31]	Reserved
010h .. 0FFh				Reserved
100h	SIO_Data_Register	Char_0	[0..7]	Character_0 Read : Read character from receive buffer Padding data, if data is not available Write : Character to transmit buffer padding data if data is invalid
		Char_1	[8..15]	Character_1 Read : Read character from receive buffer +1 Padding data, if data is not available Write : Character to transmit buffer +1 padding data if data is invalid
		Char_2	[8..15]	Character_2 Read : Read character from receive buffer +2 Padding data, if data is not available Write : Character to transmit buffer +2 padding data if data is invalid
		Char_3	[16..31]	Character_3 Read : Read character from receive buffer +3 Padding data, if data is not available Write : Character to transmit buffer +3 padding data if data is invalid
104h .. 1FFh	SIO_Data_Register_Alias		[0..31]	Alias SIO_Data_Register area for block transfer

4.9.3. SIO(RS232) Special Commands

0xF2F10018	Auto-Sync Mode control register Bit 31 : auto sync enable Bit 30 : SIO enable mode (0 : Custom mode, 1 : IIDC v1.31) Bit 27 : auto sync complete (read only. 1: ready, 0: not yet auto-sync)	Read/Write
------------	--	------------

Custom commands are valid when the Bit30 is to be set "0"(zero).

SIO(RS232) custom commands are non IIDC compliant which is a specific mode for the cameras.

Before using these commands serial communication parameters must be set at **Serial_Mode_Reg(F2F22000h)**

F2F10018 means that the RS232 command is valid.

Baud Rate	Stop Bit	Parity	Flow Control
57600 bps (default)	1 bit	None	Non

- **Command format :** [STX] [Command] [Data] [ETX]

[STX] : Command start character : 'S'

[Command] : Command length is 2byte. See next page command table.

[Data] : Data length is varied with each command. Data format is hexadecimal: '0'~'9'; 'A'~'F'.

[ETX] : Command end character : 'Z'

- **Return value**

'G' : Command complete acknowledge.

"Gdd..d" : "dd..d" is return data and hexadecimal character.

'U' : Undefined command.

- Valid Character: '0'~'9'; 'A'~'F'; 'S';'Z' Invalid character is received is discarded.

- **Example: Gain setting command with 0x200 value.**

All of "SA0200Z" , "S A0 200 Z" , "SA0 200Z" , "S A0200 Z" , and "SKA0V200Z" are parsed to "SA0200Z Z" , and "SKA0V200Z" are parsed to "SA0200Z" .

- **SIO(RS232) Commands**

STX	Command	Data Length	ETX	Return Value	Function
S	A0	3Bytes	Z	G	Gain control (0x000 ~ 0x30F(BW Model) or 2D3(Color Model)) (see gain mapping graph) Ex) SA0200Z : Gain index value 512 (18dB)
S	A1	3Bytes	Z	G	Shutter speed control (0x001 ~ 0xCFB) (see shutter speed table)
S	A2	1Bytes	Z	G	Set/Clear auto shutter speed and auto gain Bit 0 : Auto gain Bit 1 : Auto shutter speed Ex) SA21Z : set auto gain and clear auto shutter speed SA23Z : set auto gain and auto shutter speed SA20Z : clear auto gain and auto shutter speed
S	A3	2Bytes	Z	G	Auto exposure control (0x00~0x64)
S	A4	1Bytes	Z	G	Gamma control (0x0~0x19) (see gamma table)
S	A5	3Bytes	Z	G	Brightness control (0x000~0x800)
S	A6	3Bytes	Z	G	Sharpness control (0x000~0x3F8)
S	A7	1Bytes	Z	G	ISO control 1: ISO enable, 0 : disable
S	A8	1Bytes	Z	G	Trigger control 1: trigger enable, 0 : trigger disable

S	AF	0Bytes	Z	'G'+18 Byte	<p>Read feature control value Return value order 'G'[Gain] [Shutter] [Set/Clear auto gain and shutter] [Auto Exposure] [Gamma] [Brightness] [Sharpness] [ISO] [Trigger]</p> <p>Ex) At Command SAFZ, if return value is G001200132F20020101, Gain : 0x001 Shutter speed : 0x200 Set auto gain/Clear auto shutter speed : 0x1 Auto exposure : 0x32 Gamma : 0xF Brightness : 0x200 Sharpness : 0x201 ISO : 0x0 Trigger : 0x1</p>
S	B0	16Bytes	Z	G	RS232 synchronization : RS232 buffer cleared in camera.
S	B1	8Bytes	Z	G	<p>Write access of 1394 address Format : SB1 [address(8 byte)] [data(8byte)] Z Ex) SB1F2F1010012345678Z : write 0x12345678 data at 0xF2F10100 address</p>
S	B2	0Bytes	Z	'G'+8 Byte	<p>Read access of 1394 address Format : SB2 [address(8byte)] Z Ex) If command is SB2F2F10100Z and return value is G12345678, Read value of address 0xF2F10100 is 0x12345678.</p>
S	B3	3Bytes	Z	G	<p>Return to default feature value Return control feature : gain, shutter speed, auto exposure, brightness, sharpness, gamma, auto shutter speed, auto gain</p>
S	Undefined Command	Any Byte	Z	U	<p>Undefined command Return Value is 'U' character.</p>

4.10. Frame Save Function

The Fire-i ultra compact form series cameras can save their frames in the camera memory. The camera can be instructed to stop running when the maximum frames are saved in the memory. Max savable frame numbers are different according to models. The saved images are useful for multi cameras applications. IEEE1394 images are transferred by the ISO channel and 400Mbps is the max bandwidth.

of maximum save frames : address 0xF2F10128, bit 16 ~ bit 23 read value		
Resolution	Mode 800	Mode 1600/Y422
640 x 480	63 frames	31 frames
800 x 600	63 frames	31 frames
1024 x 768	31 frames	15 frames
1280 x 960	15 frames	7 frames
1600 x 1200	15 frames	7 frames

4.11. LUT (Lookup table)

The cameras support a LUT, which provides the user with an image with the user's defined dynamic range. Through the LUT, the user can process the images from saturation to dark. The LUT can be used optionally with Brightness, Sharpness and Gamma. However, the applied sequence is that the LUT is applied prior to the features like Brightness, Sharpness and Gamma.

4.11.1. 4 step knee lookup table

The user can set the 4 points for the images, called the knee, and apply them to the LUT.

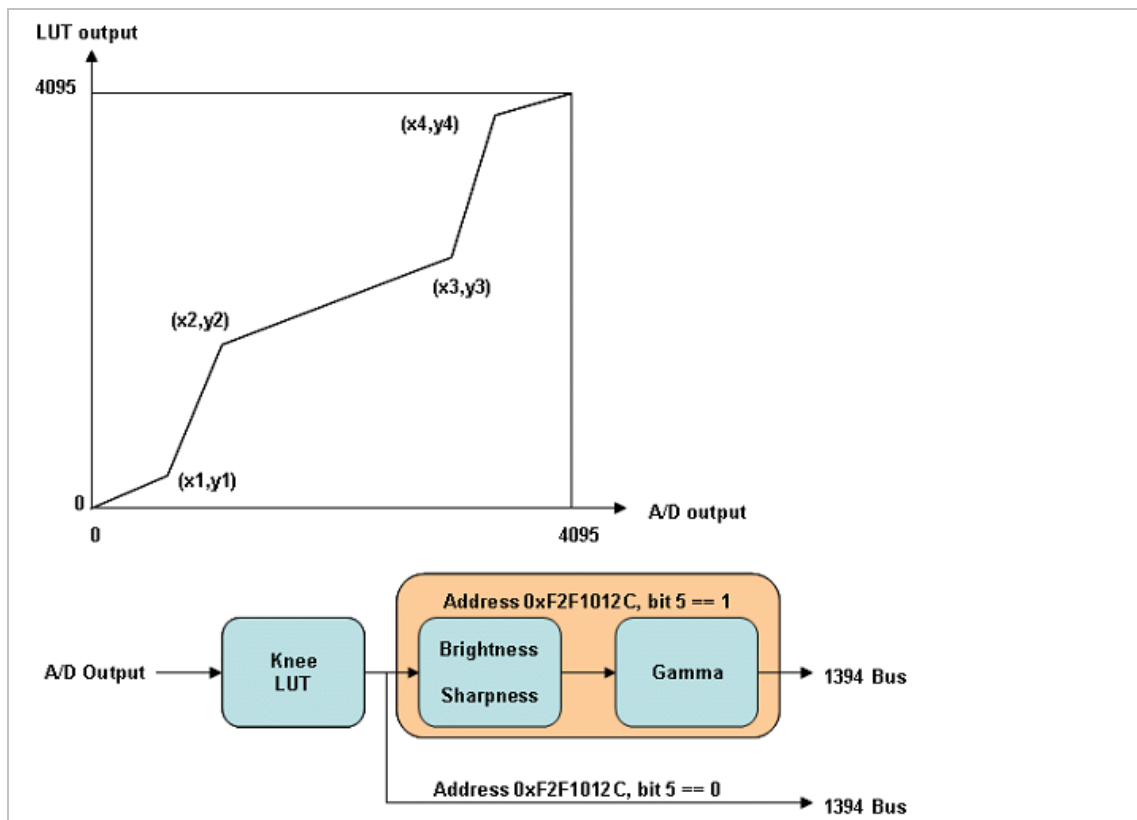

4.11.2. User defined lookup table

The users can set defined points (data file) for the images and apply them to the LUT. The user's defined LUT running procedure is as follows: LUT index is N (0~15). The total index number of user's defined LUT is 16, but only one user defined LUT is used at a time.

Priority: User's defined LUT > 4 point LUT > Features (Brightness, Sharpness, Gamma)

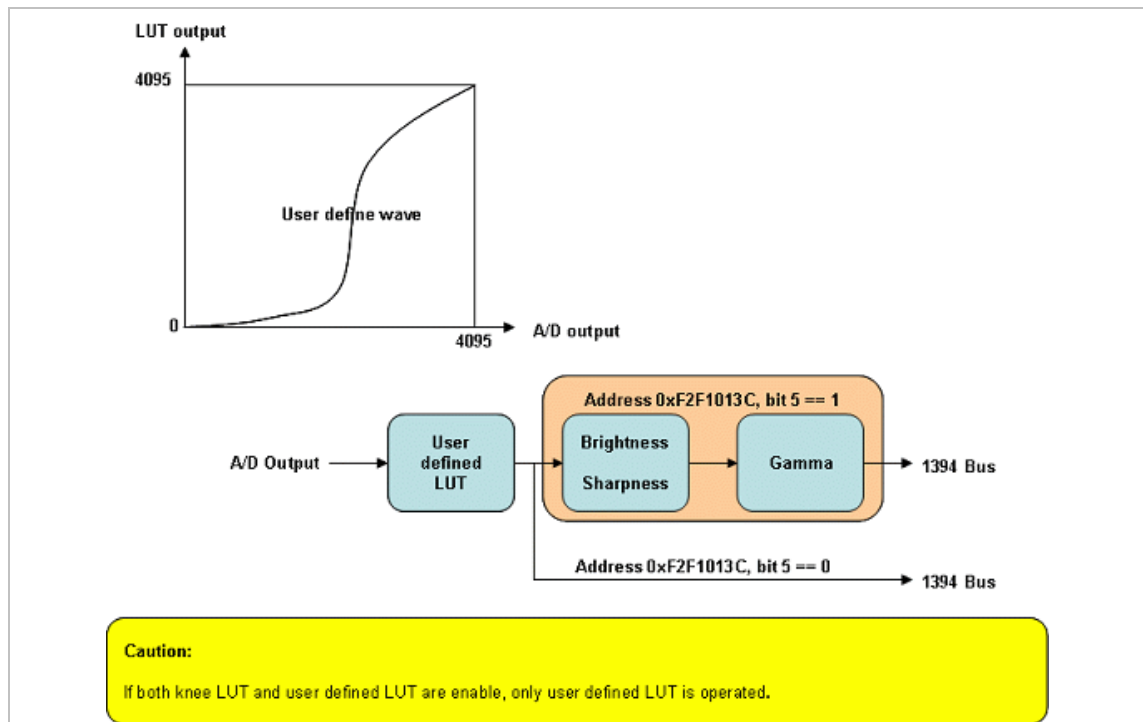

The user defined LUT save procedure is:

1. Check the save ready bit (bit1) status of the LUT save control register (0xF2F10140). If bit 1 is 0, wait.
2. Write 1 at the LUT buffer address init bit (bit7) of the LUT save control register (0xF2F10140) : 0xF2F10140 (<= 0x01000000).
3. Then write 4096 LUT data at the LUT data register (0xF2F10144).
4. Finally, write save command (bit0), LUT index (N: bit8~bit11) at the LUT save control Register (0xF2F10140): 0xF2F10140 (<= 0x80N00000).

4.12. One Pixel Snow Noise Remove

With this function, it is possible to average the value of snow noise pixel by using the neighboring pixels values. The formula used is: If $((Pi-Pi-1) > \text{Threshold} * 16)$ and $((Pi-Pi+1) > (\text{Threshold} * 16))$, Pi is bad pixel. The purpose of the function is to increase the average pixels values for the whole image and be automatically displayed and the images can be compensated by over up to 50%. The register address and values for this function are:

Address	Description (bit 0: msb)	Read/Write
0xF2F20150	One Pixel Snow Noise Remove Bit 0 : presence inquiry (read only) Bit 1 ~ Bit 5 : reserved Bit 6 : on/off Bit 7~Bit23 : reserved Bit 24~Bit31 : Threshold Value (T) : If Pixel difference value > Threshold Value, then replace near pixel average Value	Write only

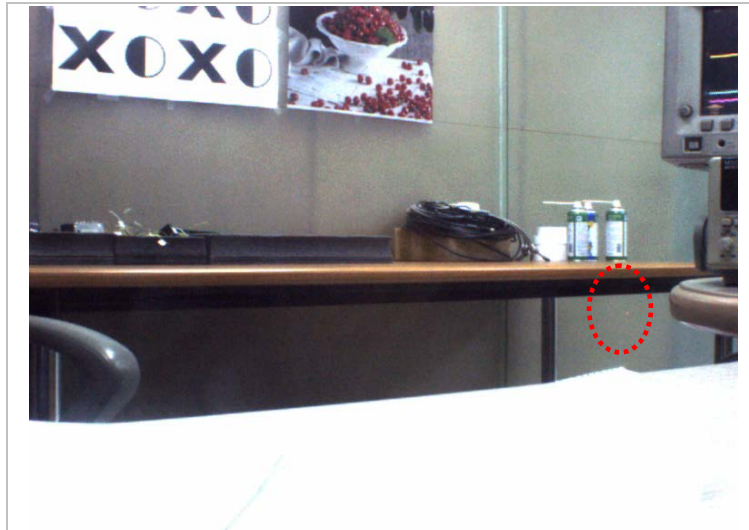

Before Snow noise image



After Snow noise removal

4.13. PIO Control Register

Short for Programmable Input/Output, PIO provides a set of IO ports which can be configured by the defined address. The PIO control register by 1394 address, for strobe and trigger signal, is as follows.

Address	Description (bit 0: msb)	Read/Write
0xF2F21000	PIO output register Bit 30 : Strobe GPIO output	Write only
0xF2F21004	PIO input register Bit 31 : trigger GPIO input	Read only
0xF2F21008	PIO GPIO enable register. Bit 30 : Strobe pin GPIO selector (1: GPIO, 0: strobe)	Read/Write

5. User Defined (custom) FIREWIRE Registers

User defined registers are features undefined in the IIDC specification which Unibrain cameras are capable of. The user can utilize extended features of the specific FireWire register for an application.

Note: For users who have had a previous version of an Unibrain Camera, several User Defined Registers have been incorporated in the IIDC V1.31 specification.

5.1. User Defined FIREWIRE Address

Address	Description(bit : msb*)	Read/Write
0xF2F10000	<p>A/D bit resolution Bit 28~Bit31 : A/D bit resolution Please refer to IIDC v1.31 data depth register (address: 0xF0F00630)</p> <p>The diagram illustrates the bit fields for A/D bit resolution. It shows three bit patterns: 1) 'Mono 8 /Raw RGB 8bit' with bits 11-0; 2) 'Mono 16 /Raw RGB 16bit' with bits 15-4, where bits 11-4 are labeled 'Null data'; 3) '12 Bit A/D Resolution' with bits 11-0, where bits 3-0 are marked 'Discard'. Bit positions 15, 8, 7, and 0 are also indicated for the 16-bit and 12-bit patterns.</p>	Read only
0xF2F10004	<p>Auto shutter-speed maximum/minimum value register. (32bit) At auto shutter mode, shutter speed value is checked between auto shutter-speed maximum value and minimum value</p> <p>The diagram shows a 32-bit register divided into two 16-bit fields. The first field, bits 0-15, is labeled 'Auto Shutter-Speed Maximum Value'. The second field, bits 16-31, is labeled 'Auto Shutter-Speed Minimum Value'.</p>	Read/Write
0xF2F10008	<p>Auto gain maximum/minimum value register.* (32bit) At auto gain mode, gain value is checked between auto gain maximum value and minimum value.</p> <p>The diagram shows a 32-bit register divided into two 16-bit fields. The first field, bits 0-15, is labeled 'Auto Gain Maximum Value'. The second field, bits 16-31, is labeled 'Auto Gain Minimum Value'.</p>	Read/Write

0xF2F10018	Mode control register Bit 31 : auto sync enable Bit 30 : SIO enable mode (0 : Custom mode, 1 : IIDC v1.31) Bit 27 : auto sync complete (read only. 1: ready, 0: not yet auto-sync)	Read/Write																																																																														
0xF2F1001C	1394 time stamp register(msb:bit0) <table border="1" style="width: 100%; text-align: center;"> <tr> <td>0</td><td>1</td><td>2</td><td>3</td><td>4</td><td>5</td><td>6</td><td>7</td><td>8</td><td>9</td><td>10</td><td>11</td><td>12</td><td>13</td><td>14</td><td>15</td><td>16</td><td>17</td><td>18</td><td>19</td><td>20</td><td>21</td><td>22</td><td>23</td><td>24</td><td>25</td><td>26</td><td>27</td><td>28</td><td>29</td><td>30</td><td>31</td> </tr> <tr> <td colspan="6">SECONDS COUNT</td> <td colspan="10">CYCLE COUNT</td> <td colspan="10">CYCLE OFFSET</td> </tr> </table> <table border="1" style="width: 100%; text-align: center;"> <thead> <tr> <th>Bit Number</th> <th>Bit Name</th> <th>Function</th> <th>DIR</th> <th>Description</th> </tr> </thead> <tbody> <tr> <td>0 - 6</td> <td>SECONDS COUNT</td> <td>Seconds Count</td> <td>R/W</td> <td>1 Hz cycle timer counter</td> </tr> <tr> <td>7 - 19</td> <td>CYCLE COUNT</td> <td>Cycle Count</td> <td>R/W</td> <td>8,000 Hz cycle timer counter</td> </tr> <tr> <td>20 - 31</td> <td>CYCLE OFFSET</td> <td>Cycle Offset</td> <td>R/W</td> <td>24.576 MHz cycle timer counter</td> </tr> </tbody> </table> <p>We recommend using native CYCLE_TIME register in Chap. 5.7.</p>	0	1	2	3	4	5	6	7	8	9	10	11	12	13	14	15	16	17	18	19	20	21	22	23	24	25	26	27	28	29	30	31	SECONDS COUNT						CYCLE COUNT										CYCLE OFFSET										Bit Number	Bit Name	Function	DIR	Description	0 - 6	SECONDS COUNT	Seconds Count	R/W	1 Hz cycle timer counter	7 - 19	CYCLE COUNT	Cycle Count	R/W	8,000 Hz cycle timer counter	20 - 31	CYCLE OFFSET	Cycle Offset	R/W	24.576 MHz cycle timer counter	Read only
0	1	2	3	4	5	6	7	8	9	10	11	12	13	14	15	16	17	18	19	20	21	22	23	24	25	26	27	28	29	30	31																																																	
SECONDS COUNT						CYCLE COUNT										CYCLE OFFSET																																																																
Bit Number	Bit Name	Function	DIR	Description																																																																												
0 - 6	SECONDS COUNT	Seconds Count	R/W	1 Hz cycle timer counter																																																																												
7 - 19	CYCLE COUNT	Cycle Count	R/W	8,000 Hz cycle timer counter																																																																												
20 - 31	CYCLE OFFSET	Cycle Offset	R/W	24.576 MHz cycle timer counter																																																																												
0xF2F10100	Power on reset condition control register Not Recommended Please refer to IIDC v1.31 memory save/load channel.	Read/Write (Self Cleared)																																																																														
0xF2F10104	Trigger control register Not Recommended Please refer to IIDC v1.31 trigger control register (address: 0xF0F00830)	Read/Write																																																																														
0xF2F10108	Software trigger Not Recommended Please refer to IIDC v1.31 software trigger register (address: 0xF0F0062C)	Read only																																																																														
0xF2F1010C	Strobe control register. Only supports active high polarity. Not Recommended Please refer to IIDC v1.31strobe control register (address: 0xF0F0048C -> 0xF2F23200)	Read/Write																																																																														
0xF2F10110	Trigger noise filter register (External trigger only) Bit 22~Bit 31 : trigger masking range (M, unit : usec, range:0~1023)	Read/Write																																																																														
0xF2F10114	Multi-cut exposure & interval time control (for Mode 14) Bit 16 ~ 31 : exposure time (E) Bit 0 ~ 15 : exposure time interval (P)	Read/Write																																																																														
0xF2F10184	Local ISO_EN control register for one-shot/multi-shot Bit 31 : iso_enable (1: enable. 0: disable)																																																																															
0xF2F1011C	Power on default memory channel Bit 0 ~ Bit 3 : power on initial memory channel	Read/Write																																																																														
0xF2F10200	Camera version register Bit 16~Bit 31 : camera version (ex: If reading value: 0x00003000, camera version is 3.000)	Read only																																																																														
0xF2F10120	Bright Level for Iris Control Application Bit 24 ~ Bit 31 : Bright Level for Image Capture	Read only																																																																														
0xF2F10124	Test Pattern Bit 0 : Vertical Grey Bar Bit 1: Bias Grey Bar	Read/Write																																																																														
0xF2F10128	Defer Image control (Frame save) Bit 0 : presence inquiry (read only) Bit 6 : defer image On/Off control (1: image hold mode, 0 : normal real time mode) Bit 7 : send image command : If bit 6 is on status, this bit is send image command from camera to PC. Bit 16 ~ Bit 23 : Queue size inquiry : Must check whenever format or mode is changed (read only) Bit 24 ~ Bit 31 : At read operation, this value is the number of remained image at queue. At write operation, this value is the number of sending images by bit 7 send	Read/Write																																																																														

	image command	
0xF2F1012C	4 step knee LUT run control register LUT knee 1st point register Bit 0 : presence inquiry (read only) Bit 1 : LUT regeneration command (self cleared) Bit 2~Bit4 : reserved Bit 5 : enable brightness, sharpness, gamma feature with knee function Bit 6 : On/Off Bit 7 : reserved Bit 8~Bit 19 : X coordination of 1st knee point Bit 20~Bit31 : Y coordination of 1st knee point	Read only
0xF2F10130	LUT knee 2nd point register Bit 0 : presence inquiry (read only) Bit 1 : LUT regeneration command (self cleared) Bit 2~Bit5 : reserved Bit 6 : reserved Bit 7 : reserved Bit 8~Bit 19 : X coordination of 2nd knee point Bit 20~Bit31 : Y coordination of 2nd knee point	Read/Write
0xF2F10134	LUT knee 3rd point register Bit 0 : presence inquiry (read only) Bit 1 : LUT regeneration command (self cleared) Bit 2~Bit5 : reserved Bit 6 : reserved Bit 7 : reserved Bit 8~Bit 19 : X coordination of 3rd knee point Bit 20~Bit31 : Y coordination of 3rd knee point	Read/Write
0xF2F10138	LUT knee 4th point register Bit 0 : presence inquiry (read only) Bit 1 : LUT regeneration command (self cleared) Bit 2~Bit5 : reserved Bit 6 : reserved Bit 7 : reserved Bit 8~Bit 19 : X coordination of 4th knee point Bit 20~Bit31 : Y coordination of 4th knee point	Read/Write
0xF2F1013C	User defined LUT run control register Bit 0 : presence inquiry (read only) Bit 1 ~ Bit 4 : reserved Bit 5 : enable brightness, sharpness, gamma feature with user defined LUT function Bit 6 : On/Off Bit 7 ~ Bit 11 : reserved Bit 12 ~ Bit 15 : run LUT index Bit 16 ~ Bit 31 : reserved	Read/Write
0xF2F10140	LUT save control register Bit 0 : save command Bit 1 : save ready status(read only) Bit 2 ~ Bit 6 : reserved Bit 7 : set LUT write buffer address to 0 Bit 8 ~ Bit 11 : save LUT index Bit 12 ~ Bit 31 : reserved	Read/Write
0xF2F10144	LUT data register (block write command) Save the first data at low word, then second data at high word Bit 0 ~ Bit 3 : reserved Bit 4 ~ Bit 15 : the second data Bit 16 ~ Bit 19 : reserved Bit 20 ~ Bit 31 : the first data	Write Only

0xF2F10150	<p>Snow noise remove threshold register</p> <p>Bit 0 : presence inquiry (read only) Bit 1 ~ Bit 5 : reserved Bit 6 : on/off Bit 7 : grid noise filter enable mode f or mono800 at color camera (0:disable, 1: enable) Bit 8~Bit23 : reserved Bit 24~Bit31 : Threshold Value (T) : If Pixel difference value > Threshold Value, the pixel is replaced with near pixel average value</p> <p style="text-align: center;">0 7 8 11 (MSB) (LSB)</p> <div style="border: 1px solid black; width: fit-content; margin: 0 auto; padding: 5px;"><div style="display: inline-block; background-color: #FFC000; padding: 2px 10px;">Threshold Value (T)</div><div style="display: inline-block; background-color: #A0A0A0; padding: 2px 10px;">0</div></div> <p style="text-align: center;">Pixel compared threshold value bit map</p>	Read/Write
0xF2F10168	<p>Another sharpness</p> <p>Bit 0 : presence inquiry (read only) Bit 1 ~ Bit 5 : reserved Bit 6 : On/Off Bit 7 : reserved Bit 8 ~ Bit 23 : reserved Bit 24 ~ Bit 31 : sharpness value (10: normal, range 5 ~ 20)</p>	Read/Write

*msb : most significant bit

6. Video Formats and Modes

IIDC 1.31 defines several video formats which determine the video data output from the camera. An overview of those formats is:

- Format 0: Video formats up to VGA (640 x 480) resolution.
- Format 1: Video formats for SVGA (800 x 600) and XGA (1024x768) resolution.
- Format 2 : Video Formats for SXGA or higher resolutions (1280 x 960 and 1600 x 1200)
- Format 6 : Still Images
- Format 7 : Scalable images sized (User defined size and position)

Format 0 / Format 1 / Format 2

In these formats, the frame rates are pre-defined for each video mode as per the IIDC specification.

There are several defined modes for each format where a mode specifies the size and color information of the pixels. By reading the inquiry register of the camera, the user may determine which frame rates are supported by the camera. Please refer to the IIDC specification for the details.

Format 7

Format modes 0, 1, & 2 were defined at the early stage of the design and development of digital industrial cameras; where cameras supported these common VESA compliant resolutions. Because the user required a flexible and definable format; camera manufacturers utilized the user definable Format 7 to meet this demand. Format 7 is extremely flexible and allows the user to define the width, height, position and pixel format of the video data where separate sets of control registers exists for each Format 7 mode.

The cameras support Format 7 modes 0,1,2 with the following base address:

Format 7 Mode 0 : F1F00000h Format 7 Mode 1 : F1F00100h Format 7 Mode 0 : F1F00200h

Offset	Name	Description
000h	MAX_IMAGE_SIZE_INQ	Maximum Horizontal / Vertical pixel number
004h	UNIT_SIZE_INQ	Horizontal and Vertical unit pixel number
008h	IMAGE_POSITION	Left / Top position of requested image region (pixel)
00Ch	IMAGE_SIZE	Width / Height of the requested image region (pixel)
010h	COLOR_CODING_ID	Color coding ID from COLOR_CODING_INQ register
014h	COLOR_CODEING_INQ	Inquiry register for color information setting
034h	PIXEL_NUMBER_INQ	Pixel number per frame
038h	TOTAL_BYTE_HI_INQ	Higher quadlet of total bytes of image data per frame
03Ch	TOTAL_BYTE_LO_INQ	Lower quadlet of total bytes of image data per frame
040h	PACKET_PARA_INQ	Unit (Minimum) bytes per packet Multiple by 4 Maximum bytes per packet Multiple by UnitBytePerPacket
044h	BYTE_PER_PACKET	Packet size, Recommended bytes per packet. If this value is zero, shall ignore this field.

Please refer to the IIDC specification for the details.

NOTE: In Format 7 Mode, frames rates may vary which may depend on Size, Color, and Maximum byte per packet, shutter and system performances.

6.1. Fire-i 830b / Fire-i 830c

Format	Mode	Resolution	60fps	30fps	15fps	7.5fps	3.75fps	1.875fps
0	0	160 x 120 YUV 444						
	1	320 x 240 YUV 422						
	2	640 x 480 YUV 411						
	3	640 x 480 YUV 422			0	0	0	
	4	640 x 480 RGB						
	5	640 x 480 Mono 8			0	0	0	
	6	640 x 480 Mono 16			0	0	0	
1	0	800 x 600 YUV 422			0	0		
	1	800 x 600 RGB 8						
	2	800 x 600 Mono 8			0	0		
	3	1024 x 768 YUV 422			0	0	0	0
	4	1024 x 768 RGB 8						
	5	1024 x 768 Mono 8			0	0	0	0
	6	800 x 600 Mono 16			0	0	0	
	7	1024 x 768 Mono 16			0	0	0	0
2	0	1280 x 960 YUV 422				0	0	0
	1	1280 x 960 RGB 8						
	2	1280 x 960 Mono 8			0	0	0	0
	3	1600 x 1200 YUV 422				0	0	0
	4	1600 x 1200 RGB 8						
	5	1600 x 1200 Mono 8			0	0	0	0
	6	1280 x 960 Mono 16				0	0	0
	7	1600 x 1200 Mono 16				0	0	0
7	0	1600 x 1200	16 fps Max at Mono 8 (Frame rate may differ in YUV, Mono 16 and Bayer)					
	1	800 x 600	29 fps 2x2 binning (H&V Binning)					
	2	1600 x 600	29 fps 1x2 binning (V Binning)					

6.2. Fire-i 630b / Fire-i 630c

Format	Mode	Resolution	60fps	30fps	15fps	7.5fps	3.75fps	1.875fps	
0	0	160 x 120 YUV 444							
	1	320 x 240 YUV 422							
	2	640 x 480 YUV 411							
	3	640 x 480 YUV 422		0	0	0	0		
	4	640 x 480 RGB							
	5	640 x 480 Mono 8		0	0	0	0		
	6	640 x 480 Mono 16		0	0	0	0		
1	0	800 x 600 YUV 422		0	0	0	0		
	1	800 x 600 RGB 8							
	2	800 x 600 Mono 8		0	0	0			
	3	1024 x 768 YUV 422			0	0	0	0	
	4	1024 x 768 RGB 8							
	5	1024 x 768 Mono 8		0	0	0	0	0	
	6	800 x 600 Mono 16		0	0	0	0		
7	0	1024 x 768	30 fps Max at Mono 8 (Frame rate may differ in YUV, Mono 16 and Bayer)						
	1	512x384	58 (512x384, Format7 mode1, 2x2 binning, B/W only)						
	2	1024x384	58 (1024x384, Format7 mode2, 1x2 binning, B/W only)						

6.3. Fire-i 530b / Fire-i 530c

Format	Mode	Resolution	60fps	30fps	15fps	7.5fps	3.75fps	1.875fps	
0	0	160 x 120 YUV 444							
	1	320 x 240 YUV 422							
	2	640 x 480 YUV 411							
	3	640 x 480 YUV 422		0	0	0	0		
	4	640 x 480 RGB							
	5	640 x 480 Mono 8	0	0	0	0	0		
	6	640 x 480 Mono 16		0	0	0	0		
7	0	640 x 480	60 fps Max at Mono 8 (Frame rate may differ in YUV, Mono 16 and Bayer)						
	1	320x240	120 (320x240, Format7 mode1, 2x2 binning, B/W only)						
	2	640x240	120 40x240, Format7 mode2, 1x2 binning, B/W only)						

6.4. Fire-i 850c

Format	Mode	Resolution		60fps	30fps	15fps	7.5fps	3.75fps	1.875fps
0	3	640 x 480	YUV 422		0	0	0	0	
	5	640 x 480	Mono 8	0	0	0	0	0	
	6	640 x 480	Mono 16		0	0	0	0	
1	0	800 x 600	YUV 422			0	0	0	
	2	800 x 600	Mono 8		0	0	0		
	3	1024 x 768	YUV 422			0	0	0	
	5	1024 x 768	Mono 8		0	0	0	0	
	6	800 x 600	Mono 16			0	0	0	
	7	1024 x 768	Mono 16			0	0	0	
2	0	1280 x 960	YUV 422				0	0	
	2	1280 x 960	Mono 8			0	0	0	
	3	1600 x 1200	YUV 422				0	0	
	5	1600 x 1200	Mono 8			0	0	0	
	6	1280 x 960	Mono 16				0	0	
	7	1600 x 1200	Mono 16				0	0	
7	0	2048 x 1536	10 fps Max at Mono 8 (Frame rate may differ in YUV, Mono 16 and Bayer)						
	1	1024 x 768	26 fps Max at Mono 8 (Frame rate may differ in YUV, Mono 16 and Bayer)						

6.5. Fire-i 550b / Fire-i 550c

Format	Mode	Resolution		60fps	30fps	15fps	7.5fps	3.75fps	1.875fps
0	3	640 x 480	YUV 422		0	0	0	0	
	5	640 x 480	Mono 8	0	0	0	0	0	
	6	640 x 480	Mono 16		0	0	0	0	
7	0	752 x 480	60 fps Max at Mono 8 (Frame rate may differ in YUV, Mono 16 and Bayer)						
	1	320x240	110 fps Max at YUV						
	2	752x476	30 fps Ma at Mono 8 (B/W only)						

6.6. Trouble Shooting

FireWire based cameras are operated in connection with system where the user may encounter problems as they operate. These problems may orient either from the camera side or the system side that the camera is being used. We recommend reading the manual carefully beginning from the installation to features in concern. Also some system may not have enough power to operate these cameras, especially for high resolution and high frame rate. We recommend the system should be Pentium 4 or higher with 256MB of System memory and Graphic Accelerator with 32MB or more of video memory. When using Windows, due to high graphic requirements and DirectX support, we recommend using at least MX400 (Nvidia) or Radeon (ATI) or higher graphics controllers.

6.7. Hardware Related Issues

6.7.1. Camera is not recognized in the device manager

- Please check whether the LED on the back of the camera is ON. If the LED is tuned OFF, please check the camera connection. Please check the cable connection on both the camera and the PC. The LED status, when plugging in the camera is supposed to be normal when the LED light changes from an Orange light to a Red light.
- If you haven't installed the camera driver yet, please refer to the software installation manual and install the drivers and software provided.
- Please reconnect the camera by plugging the FireWire cable into the computer and then plugging the cable into the camera.

6.7.2. LED is OFF while power is provided either by FireWire or external power.

- Please check the supplied voltage and ensure that the supplied power is compliant with the operation manual.
- Please check the OHCI card and the 1394 cables.
- Please check the supplied voltage and ensure the supplied power is compliant with the operation manual.

6.7.3. No Image or Black Image is Displayed

The "Status LED" should appear Green. If not, the camera is not Isochronous enabled; which means it is not transmitting any image and it is in an idle stage.

Check whether the lens is properly mounted and open the iris to the maximum level.

Check feature values such as shutter speed, gain and exposure. Also check whether the camera is in trigger mode.

7. Technical Support

We ensure the conformity of our product to be reliable and free from defects during manufacturing by testing all the cameras before release. However unexpected problems and technical issues may come up due to the complexity of the product. In case you require technical support contact the agent near you or may contact us directly at the following locations:

Web information, specifications, FAQs: <http://www.unibrain.com/>

Technical support email: support@unibrain.com

Sales inquiries: sales@unibrain.com

Telephone Numbers: Europe/Asia: +30210-6640600

USA/Canada/South America: +1-925-866-3000

In case of RMA, you must first contact us or your local reseller in order to obtain the RMA Number before sending the product to us. The returns contact email address is: rma@unibrain.com